



**OfficeSource**<sup>®</sup>  
FURNITURE

INSPIRING FURNITURE SOLUTIONS FOR THE MODERN OFFICE



**2024** CATALOG

OfficeSource.com  
800 388 8202



MODERN  
*Elegance*

MIRA

 OfficeSource®  
FURNITURE





REMINGTON



TABLE OF CONTENTS

**DESKS**

Wood Veneer ..... 4-13  
 Laminate ..... 14-75  
 Laminate & Steel ..... 28-29  
 Height Adjustable ..... 76-81  
 Reception ..... 82-94

**SHIELDS**

Fabric & Acrylic ..... 95-96  
 Laminate & Acrylic ..... 96  
 Brackets ..... 97

**PANELS**

Partitions ..... 98-101  
 Magnetic Dry-Erase Boards ..... 102  
 Magnetic Mobile Glass Boards ..... 103

**TABLES**

Laminate Training ..... 104-111  
 Laminate Conference ..... 112-114  
 Wood Veneer Conference ..... 114  
 Multi-Purpose ..... 115-126  
 Hospitality ..... 127-130  
 Hospitality + Outdoor ..... 131  
 Folding & Educational ..... 132-133

**SEATING**

Reception + Guest ..... 134-154

Educational + Folding ..... 155  
 Stacking ..... 156-163  
 Nesting ..... 164-165  
 Stools ..... 166-173  
 Mesh ..... 174-194  
 Executive ..... 195-209  
 Big & Tall + Guest ..... 210-215  
 Seating Functions ..... 216  
 Seating Accessories ..... 217

**STORAGE**

Laminate Bookcases ..... 218  
 Steel Bookcases ..... 219  
 Heavy Duty Wire Racks ..... 219  
 Laminate Lateral Files ..... 220  
 Steel Lateral Files ..... 220-221  
 Benching Cabinets ..... 221  
 Laminate Storage Cabinets ..... 222  
 Steel Storage Cabinets ..... 223  
 Laminate Pedestals & Cubbies ..... 224  
 Metal Pedestals ..... 225  
 Metal Open Hanging Storage ..... 225  
 Steel Vertical Files ..... 226

**ACCESSORIES + TECHNOLOGY**

Modular Electric Systems ..... 227  
 Monitor Arms ..... 228  
 Task Lighting ..... 229

Wire Management ..... 229  
 Grommets ..... 230  
 Power Inserts + Modules ..... 231-232  
 Center Drawer ..... 232  
 Keyboard Systems ..... 232-233  
 CPU Holder ..... 233  
 Chair Mats ..... 234-236

**INDEX**

By Collection ..... 237

**SO = SPECIAL ORDER** Special order items are indicated with **SO** before the model number. Note that lead times on special order items can vary greatly.

**QS = QUICKSHIP** Quickship items are indicated with **QS** before the model number. Please note that delivery time is approximately 1-3 weeks.

Prices subject to change. Contact us to verify current pricing.

Colors pictured in the catalog are representation only. If exact color match is necessary, please request finish or upholstery sample before placing your order. This catalog and its contents are proprietary to COE Distributing. Copyright 2023/2024 by COE Distributing. All Rights Reserved. Printed in the U.S.A.



We strongly support recycling efforts.





**ROWLAND**

**Executive Typical ROWLAND1**  
 Total List: \$15,378.00  
 Includes: CM720, CM682, CM689 & CM450  
 Excludes Accessories

**A 72"W Executive Desk CM720**  
 72"W x 35"D x 30"H  
 List: \$5,063.00

**B Executive Hutch CM682**  
 70"W x 14"D x 42"H  
 List: \$3,226.00  
 Use with CM689

**C Knee Space Credenza CM689**  
 72"W x 24"D x 30"H  
 List: \$4,518.00

**D 2 Drawer Lateral File CM450**  
 36"W x 23"D x 30"H  
 List: \$2,571.00



**U Shape Typical ROWLAND2**  
 Total List: \$13,904.00  
 Includes: CM684R, CM684B, CM684RC & CM682  
 Excludes Accessories

**E U Shape Desk w/Right Credenza CM684R (Desk)**  
**CM684B (Bridge)**  
**CM684RC (Credenza)**  
 Desk: 72"W x 30"D x 30"H  
 Bridge: 50"W x 24"D x 30"H  
 Credenza: 72"W x 24"D x 30"H  
 List: \$4,580.00 (Desk)  
 List: \$2,031.00 (Bridge)  
 List: \$4,067.00 (Credenza)



MH Mahogany

Some items in this collection come ready-to-assemble.





**Conference Typical ROWLAND4**  
 Total List: \$10,796.00  
 Includes: CM2048 (2) & CM3072 (2)  
 Excludes Accessories

## ROWLAND

**F Open Bookcase CM3072**  
 30"W x 14"D x 72"H  
 List: \$2,323.00

**G 48"W Conference Table CM2048**  
 48"W x 48"D x 30"H  
 List: \$3,075.00

*Multiple tables can be put together to create your desired length.*

**H L Shape Desk w/Right Return CM684R (Desk) CM684RR (Return)**  
 Desk: 72"W x 30"D x 30"H  
 Return: 50"W x 24"D x 30"H  
 List: \$4,580.00 (Desk)  
 List: \$3,305.00 (Return)

*Note: Must purchase both desk & return. Return is not reversible.*

**L Shape Desk w/Left Return CM684L (Desk) CM684LR (Return)**  
 Desk: 72"W x 30"D x 30"H  
 Return: 50"W x 24"D x 30"H  
 List: \$4,580.00 (Desk)  
 List: \$3,305.00 (Return)

*Note: Must purchase both desk & return. Return is not reversible.*



**L Shape Typical ROWLAND3**  
 Total List: \$11,111.00  
 Includes: CM684R, CM684RR & CM682  
 Excludes Accessories

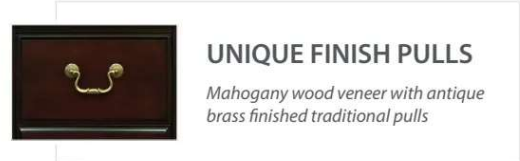

### UNIQUE FINISH PULLS

*Mahogany wood veneer with antique brass finished traditional pulls*



MH Mahogany

Some items in this collection come ready-to-assemble.





**Executive Typical  
MARKLE 1**  
Total List: \$18,180.00  
Includes: FL680, FL682,  
FL689, FL450 & FL3072  
Excludes Accessories

## MARKLE

- |  |  |  |   |   |
|--|--|--|---|---|
| <p><b>A 68"W Executive Desk<br/>FL680</b><br/>68¼"W x 32"D x 30"H<br/>List: \$5,580.00</p> | <p><b>B Executive Hutch<br/>FL682</b><br/>69¼"W x 13"D x 42"H<br/>List: \$2,955.00</p> | <p><b>C Knee Space Credenza<br/>FL689</b><br/>68¼"W x 24"D x 30"H<br/>List: \$4,735.00</p> | <p><b>D 2 Drawer Lateral File<br/>FL450</b><br/>32"W x 21"D x 30"H<br/>List: \$2,645.00</p> | <p><b>E Open Bookcase<br/>FL3072</b><br/>30"W x 13½"D x 72"H<br/>List: \$2,265.00</p> |
|--|--|--|---|---|



### UNIQUE FINISH PULLS

*Rich espresso wood veneer with  
satin nickel finished traditional pulls*

### ADDITIONAL PRODUCTS



*Create a classy storage  
option with both  
bookcases  
side-by-side together.*

**Bookcase w/Doors  
QSFL3072D**  
30"W x 13½"D x 72"H  
List: \$2,650.00



RE Rich Espresso

**QS = QUICKSHIP**

Items in this collection come fully assembled.



*FL680 Shown - User Side  
Two Locking Legal/File Drawers*





**MARKLE**

**NEW! Executive Typical**  
**QS MARKLE3**  
 Total List: \$19,470.00  
 101"W x 135"D x 72"H  
 Includes: FL684R, FL684RR, FL450,  
 FL682, FL3072 & QS FL3072D  
 Excludes Accessories

**FEATURES**

- Modern office that blends traditional design elements with contemporary influences
- Crown molding with picture frame detailing
- Satin nickel hardware complements the rich, espresso hardwood veneer finish

**PRODUCT FEATURES**



Crown molding edges on the bottom of casegoods



Satin nickel hardware set on picture frame detailing for drawers



L Shape Desk - Right (Pictured)

**F L Shape Desk w/Right Return**

**FL684R (Desk)**

**FL684RR (Return)**

Desk: 68¼"W x 28"D x 30"H

Return: 47¼"W x 22"D x 30"H

List: \$5,152.00 (Desk)

List: \$3,803.00 (Return)

Note: Must purchase both desk & return. Return is **not** reversible.

**G L Shape Desk w/Left Return**

**FL684L (Desk)**

**FL684LR (Return)**

Desk: 68¼"W x 28"D x 30"H

Return: 47¼"W x 22"D x 30"H

List: \$5,152.00 (Desk)

List: \$3,803.00 (Return)

Note: Must purchase both desk & return. Return is **not** reversible.



L Shape Desk - Left (Pictured)



RE Rich Espresso

**QS = QUICKSHIP**

Items in this collection come fully assembled.



**Executive Typical**  
**REFINED2W**  
 Total List: \$26,752.00  
 Includes: IMHF680W,  
 IMHF682W, IMHF689W,  
 IMHF450W & IMHF4078DW  
 Excludes Accessories

**REFINED**  
 Vintage Linen Finish

**A 70"W Executive Desk**  
**IMHF680W**  
 70"W x 30"D x 31"H  
 List: \$7,099.00

**B Executive Hutch**  
**IMHF682W**  
 71"W x 14"D x 49"H  
 List: \$5,397.00

**C Knee Space Credenza**  
**IMHF689W**  
 70"W x 21"D x 31"H  
 List: \$5,671.00

**D 2 Drawer Lateral File**  
**IMHF450W**  
 36"W x 21"D x 31"H  
 List: \$3,403.00

**E Bookcase w/Doors**  
**QSIMHF4078DW**  
 40"W x 14"D x 78"H  
 List: \$5,182.00

**Open Bookcase**  
**QSIMHF4078W**  
 40"W x 14"D x 78"H  
 List: \$4,674.00

**ADDITIONAL PRODUCTS**



**60"W Writing Desk**  
**IMHF384W**  
 60"W x 28"D x 31"H  
 List: \$3,598.00



VL Vintage Linen  
 w/Dry Gray Tops

**QS = QUICKSHIP**

Items in this collection come fully assembled.



**L Shape Desk w/Right Return**  
**IMHF684RW (Desk)**  
**IMHF684RRW (Return)**  
 Desk: 69½"W x 30"D x 31"H  
 Return: 47½"W x 21"D x 31"H  
 List: \$6,473.00 (Desk)  
 List: \$4,732.00 (Return)

*Note: Must purchase both desk & return.  
 Return is not reversible.*



**L Shape Open Desk w/Right Return**  
**IMHF386RW (Desk)**  
**IMHF386RRW (Return)**  
 Desk: 60"W x 28"D x 31"H  
 Return: 47½"W x 21"D x 31"H  
 List: \$3,403.00 (Desk)  
 List: \$2,229.00 (Return)

*Note: Must purchase both desk & return.  
 Return is not reversible.*





**Executive Typical  
REFINED 1**  
Total List: \$21,570.00  
Includes: IMHF680, IMHF682,  
IMHF689 & IMHF450  
Excludes Accessories

**REFINED**  
Vintage Black Finish

**A 70"W Executive Desk  
IMHF680**  
70"W x 30"D x 31"H  
List: \$7,099.00

**B Executive Hutch  
IMHF682**  
71"W x 14"D x 49"H  
List: \$5,397.00

**C Knee Space Credenza  
IMHF689**  
70"W x 21"D x 31"H  
List: \$5,671.00

**D 2 Drawer Lateral File  
IMHF450**  
36"W x 21"D x 31"H  
List: \$3,403.00

**ADDITIONAL PRODUCTS**



**60"W Writing Desk  
QSIMHF384**  
60"W x 28"D x 31"H  
List: \$3,598.00

**60"W Sit/Stand Desk  
QSIMHF384T (Top Only)**  
60"W x 28"D x 30"H  
List: \$2,972.00

See Pages 77-78 for  
available 48" HAT Units

**Bookcase w/Doors  
QSIMHF4078D**  
40"W x 14"D x 78"H  
List: \$5,182.00

**Open Bookcase  
QSIMHF4078**  
40"W x 14"D x 78"H  
List: \$4,674.00



**L Shape Desk w/Right Return  
IMHF684R (Desk)  
IMHF684RR (Return)**  
Desk: 69½"W x 30"D x 31"H  
Return: 47½"W x 21"D x 31"H  
List: \$6,473.00 (Desk)  
List: \$4,732.00 (Return)

Note: Must purchase both desk & return.  
Return is not reversible.



**L Shape Open Desk w/Right Return  
QSIMHF386R (Desk)  
QSIMHF386RR (Return)**  
Desk: 60"W x 28"D x 31"H  
Return: 47½"W x 21"D x 31"H  
List: \$3,403.00 (Desk)  
List: \$2,229.00 (Return)

Note: Must purchase both desk & return.  
Return is not reversible.

**QS = QUICKSHIP**

Items in this collection come fully assembled.



BK Vintage Black  
w/Wood Plank Tops



**Executive Typical  
MONROE1**  
Total List: \$22,210.00  
Includes: IMCA680, IMC682,  
IMCA689, IMCA450 & IMCA4076  
Excludes Accessories

**MONROE**

- |  |  |  |  |   |
|--|--|--|--|---|
| <p><b>A 68"W Executive Desk</b><br/><b>IMCA680</b><br/>68"W x 28"D x 30"H<br/>List: \$5,975.00</p> | <p><b>B Executive Hutch</b><br/><b>IMCA682</b><br/>70"W x 15"D x 46"H<br/>List: \$4,475.00</p> | <p><b>C Knee Space Credenza</b><br/><b>IMCA689</b><br/>68"W x 19"D x 30"H<br/>List: \$5,145.00</p> | <p><b>D 2 Drawer Lateral File</b><br/><b>IMCA450</b><br/>36"W x 21"D x 31"H<br/>List: \$3,045.00</p> | <p><b>E Open Bookcase</b><br/><b>IMCA4076</b><br/>40"W x 15"D x 76"H<br/>List: \$3,570.00</p> |
|--|--|--|--|---|

**ADDITIONAL PRODUCTS**



**60"W Sit/Stand Desk**  
**QSIMCA384T (Top Only)**  
60"W x 27"D x 6"H  
List: \$2,845.00

See Pages 77-78 for available 48" HAT Units

**54"W Writing Desk**  
**QSIMCA384**  
54"W x 27"D x 30"H  
List: \$3,050.00

**QS = QUICKSHIP**

Items in this collection come fully assembled.



**GR Weathered**  
Dove Gray



**L Shape Desk w/Right Return**

**IMCA684R (Desk)**  
**IMCA684RR (Return)**  
Desk: 68"W x 28"D x 30"H  
Return: 48"W x 24"D x 30"H  
List: \$4,510.00 (Desk)  
List: \$3,265.00 (Return)

Note: Must purchase both desk & return.  
Return is not reversible.



**L Shape Open Desk w/Right Return**

**QSIMCA386R (Desk)**  
**QSIMCA386RR (Return)**  
Desk: 60"W x 27"D x 30"H  
Return: 48"W x 21"D x 30"H  
List: \$2,600.00 (Desk)  
List: \$2,245.00 (Return)

Note: Must purchase both desk & return.  
Return is not reversible.





## STOCKTON

### Executive Typical STOCKTON1

Total List: \$18,863.00  
Includes: IMKN680, IMKN682,  
IMKN689 & QSIMKN3678D  
Excludes Seating & Accessories

**A 66"W Executive Desk**  
IMKN680  
66"W x 28"D x 30"H  
List: \$5,472.00

**B Executive Hutch**  
IMKN682  
66"W x 14"D x 48"H  
List: \$4,448.00

**C Knee Space Credenza**  
IMKN689  
66"W x 22"D x 30"H  
List: \$4,927.00

**D Bookcase w/Doors**  
QSIMKN3678D  
36"W x 14"D x 78"H  
List: \$4,016.00

**Open Bookcase**  
IMKN3678  
36"W x 14"D x 78"H  
List: \$3,820.00

### UNIQUE DETAILS

*Raised criss-cross inlays  
gives this collection a  
stately and refined look*



### ADDITIONAL PRODUCTS

**60"W Writing Desk**  
QSIMKN384  
60"W x 28"D x 30"H  
List: \$2,734.00

**2 Drawer Lateral File**  
IMKN450  
36"W x 22"D x 30"H  
List: \$3,154.00

**60"W Sit/Stand Desk**  
QSIMKN384T (Top Only)  
60"W x 28"D x 30"H  
List: \$2,113.00

**4 Door Console**  
QSIMKN370  
70"W x 18"D x 32"H  
List: \$4,037.00

See Pages 77-78 for  
available 48" HAT Units

#### QS = QUICKSHIP

Items in this collection come fully assembled.



DC Dark Chocolate



### L Shape Desk w/Right Return

**IMKN684R (Desk)**  
**IMKN684RR (Return)**  
Desk: 66"W x 28"D x 30"H  
Return: 44"W x 21"D x 30"H  
List: \$5,141.00 (Desk)  
List: \$3,278.00 (Return)

Note: Must purchase both desk & return.  
Return is not reversible.



**PALMER**

**Executive Typical**  
**QS PALMER1**  
 Total List: \$28,033.00  
 Includes: QSIMTE680, IMTE450,  
 QSTE4094 (3) & IMTE402  
 Excludes Accessories

**A 68"W Executive Desk**  
**QSIMTE680**  
 68"W x 30"D x 30"H  
 List: \$6,032.00

**B 2 Drawer Lateral File**  
**QSIMTE450**  
 36"W x 22"D x 30"H  
 List: \$3,276.00

**C Open Bookcase**  
**QSTE4094**  
 40"W x 15"D x 94"H  
 List: \$5,642.00

**D Metal Ladder**  
**QSIMTE402**  
 14½"W x 3"D x 90"H  
 List: \$1,799.00  
 Use with TE4094

**ADDITIONAL PRODUCTS**



**72"W Writing Desk**  
**QSIMTE384**  
 72"W x 30"D x 30"H  
 List: \$3,305.00



**Buffet Credenza**  
**QSIMTE689**  
 68"W x 18"D x 30"H  
 List: \$4,996.00



*User Side  
 Two-Tone Colors*



**QS = QUICKSHIP**  
 Items in this collection come fully assembled.

AE Aged Ebony  
 w/Honey Wood





## WESTWOOD

### Executive Typical WESTWOOD1

Total List: \$26,330.00  
Includes: IMSA680, IMSA682,  
IMSA689 & IMSA450  
Excludes Accessories

**A 68"W Executive Desk**  
**IMSA680**  
68"W x 28"D x 30"H  
List: \$8,430.00

**B Executive Hutch**  
**IMSA682**  
68"W x 14"D x 48"H  
List: \$6,510.00

**C Knee Space Credenza**  
**IMSA689**  
68"W x 24"D x 30"H  
List: \$7,470.00

**D 2 Drawer Lateral File**  
**IMSA450**  
36"W x 22"D x 30"H  
List: \$3,920.00

## ADDITIONAL PRODUCTS



**Left Tall Bookcase**  
**QSIMSA4094L**  
40"W x 14"D x 94"H  
List: \$7,605.00

**Center Tall Bookcase**  
**QSIMSA4094C**  
40"W x 14"D x 94"H  
List: \$7,605.00

**Right Tall Bookcase**  
**QSIMSA4094R**  
40"W x 14"D x 94"H  
List: \$7,605.00



**Wood Ladder**  
**QSIMSA402**  
14¾"W x 3"D x 75"H  
List: \$961.00  
Use with *IMSA4094*

**Open Bookcase**  
**IMSA3678**  
36"W x 14"D x 78"H  
List: \$4,955.00

**54"W Writing Desk**  
**QSIMSA384**  
54"W x 28"D x 30"H  
List: \$3,390.00

**Bookcase w/Doors**  
**QSIMSA3678D**  
36"W x 14"D x 78"H  
List: \$6,154.00

### QS = QUICKSHIP

Items in this collection come fully assembled.



### L Shape Desk w/Right Return

**QSIMSA684R (Desk)**  
**QSIMSA684RR (Return)**  
Desk: 68"W x 28"D x 30"H  
Return: 44"W x 22"D x 30"H  
List: \$7,395.00 (Desk)  
List: \$4,535.00 (Return)

*Note: Must purchase both desk & return.  
Return is not reversible.*



DR Dark Roast  
w/Wood Tops



**ARTISAN**  
Natural Finish

**Executive Typical ARTISAN1**  
Total List: \$12,093.00  
Includes: MNM680, MNM682, MNM689 & MNM3678D  
Excludes Accessories

**A 66"W Executive Desk**  
MNM680  
66"W x 30"D x 31"H  
List: \$3,656.00

**B Executive Hutch**  
MNM682  
66"W x 12"D x 47½"H  
List: \$2,354.00

**C Knee Space Credenza**  
MNM689  
66"W x 21"D x 31"H  
List: \$3,287.00

**D Bookcase w/Doors**  
MNM3678D  
36"W x 12"D x 78"H  
List: \$2,796.00

**Open Bookcase**  
MNM3678  
36"W x 12"D x 78"H  
List: \$2,576.00

**UNIQUE FINISH**  
Natural finish with chocolate solid wood framed legs

**ADDITIONAL PRODUCTS**

**60"W Writing Desk**  
MNM384  
60"W x 30"D x 31"H  
List: \$2,201.00

**2 Drawer Lateral File**  
MNM450  
34"W x 21"D x 31"H  
List: \$2,214.00

**E L Shape Open Desk w/Right Return**  
MNM386R (Desk)  
MNM386RR (Return)  
Desk: 66"W x 30"D x 31"H  
Return: 48"W x 21"D x 31"H  
List: \$2,167.00 (Desk)  
List: \$1,434.00 (Return)

*Note: Must purchase both desk & return. Return is not reversible.*

**57"W Sit/Stand Desk**  
MNM384T (Top Only)  
57"W x 24"D x 30"H  
List: \$1,624.00

**Mobile Pedestal Box/File**  
MNM202  
18"W x 20"D x 24"H  
List: \$1,477.00

See Pages 77-78 for available 48" HAT Units  
Some items in this collection come ready-to-assemble.



NA Natural







**ARTISAN**  
Cement Finish

**Executive Typical  
ARTISAN2**  
Total List: \$7,654.00  
Includes: MNC386R, MNC386RR,  
MNC202 & MNC3678  
Excludes Accessories

**A L Shape Open Desk w/Right Return**  
MNC386R (Desk)  
MNC386RR (Return)  
Desk: 66"W x 30"D x 31"H  
Return: 48"W x 21"D x 31"H  
List: \$2,167.00 (Desk)  
List: \$1,434.00 (Return)  
*Note: Must purchase both desk & return.  
Return is not reversible.*

**B Mobile Pedestal  
Box/File**  
MNC202  
18"W x 20"D x 24"H  
List: \$1,477.00

**C Open Bookcase**  
MNC3678  
36"W x 12"D x 78"H  
List: \$2,576.00  
**Bookcase w/Doors**  
MNC3678D  
36"W x 12"D x 78"H  
List: \$2,796.00

**UNIQUE FINISH**

Cement finish with black  
solid wood framed legs



**ADDITIONAL PRODUCTS**

**66"W Executive Desk**  
MNC680  
66"W x 30"D x 31"H  
List: \$3,656.00

**Executive Hutch**  
MNC682  
66"W x 12"D x 47½"H  
List: \$2,354.00

**Knee Space Credenza**  
MNC689  
66"W x 21"D x 31"H  
List: \$3,287.00

**2 Drawer Lateral File**  
MNC450  
34"W x 21"D x 31"H  
List: \$2,214.00

**60"W Writing Desk**  
MNC384  
60"W x 30"D x 31"H  
List: \$2,201.00

**57"W Sit/Stand Desk**  
MNC384T (Top Only)  
57"W x 24"D x 30"H  
List: \$1,624.00

See Pages 77-78 for  
available 48" HAT Units



CT Cement

Some items in this collection come  
ready-to-assemble.



**NEW! LUCCA**  
Walnut with Charcoal Finish

*Pictured w/Palma Seating*

**A L Shape Desk  
w/Reversible Return  
OSXD2001**  
Desk: 72"W x 30"D x 30"H  
Return: 40<sup>3</sup>/<sub>16</sub>"W x 20"D x 27<sup>1</sup>/<sub>4</sub>"H  
List: \$1,400.00

**B 2 Drawer Lateral File  
OSXS2003**  
35"W x 20"D x 30"H  
List: \$1,200.00

**C 5 Shelf Bookcase  
OSXS2004**  
47<sup>1</sup>/<sub>4</sub>"W x 15"D x 69<sup>1</sup>/<sub>2</sub>"H  
List: \$1,250.00

**D 3 Shelf Console Bookcase  
OSXS2005**  
47<sup>1</sup>/<sub>4</sub>"W x 15"D x 43"H  
List: \$850.00

**E Mobile Pedestal  
Box/File  
OSXP2002**  
16<sup>1</sup>/<sub>4</sub>"W x 22<sup>7</sup>/<sub>16</sub>"D x 23<sup>7</sup>/<sub>16</sub>"H  
List: \$800.00

**F 60"W Conference Table  
OSXC2006**  
60"W x 30"D x 30"H  
List: \$925.00

*Store Books Or Knickknacks  
With These Cubicle Shelves*



*Lateral File & Mobile Pedestal  
Come With Locks On Top Drawer*

**SLEEK & MODERN PULLS**

*Lateral file and mobile pedestal come with black metal pulls for Walnut with Charcoal finish*

*Lateral file and mobile pedestal come with white metal pulls for Cypress with Pearl White finish*







**NEW! LUCCA**  
Cypress with Pearl White Finish

*Pictured w/Merak Seating*

**FEATURES**

- Contemporary design with 1.8" thick tops and sides; 5-Shelf and 3-Shelf bookcases have 1.5" thick tops, sides and shelves
- Unique two-tone color design in two color combinations
- Adjustable foot levelers available on L Shape Desk, 2 Drawer Lateral File, Bookcases and Conference Table
- Manufactured with durable, melamine laminate
- Some assembly required; Lateral File & Mobile Pedestal come fully assembled



*Four Chairs Can Fit Comfortably  
With Two On Each Side*



*Shown in Walnut w/Charcoal*



*Pictured w/Merak Seating*



*Pictured w/Palma Seating*



**Multi-Person Typical SIENNA5**  
 Total List: \$9,476.00  
 Includes: OX9170 (2), OX9180 (2), OX9WDS80 (2), OX9DRW80 (2), OX9MP01 (2), OX956 (2) & OX9WD56 (2)  
 Excludes Seating & Accessories  
 Pictured w/CoolMesh & Value Seating

## SIENNA

**A 60"W Table Top w/Two Legs OX9130**  
 60"W x 29½"D x 29½"H  
 List: \$758.00

**66"W Table Top w/Two Legs OX9150**  
 66"W x 29½"D x 29½"H  
 List: \$784.00

**71"W Table Top w/Two Legs OX9190**  
 71"W x 29½"D x 29½"H  
 List: \$830.00

**82"W Table Top w/Two Legs OX9170**  
 82½"W x 35½"D x 29½"H  
 List: \$1,102.00

**B Modesty Panel (w/Hanging Brackets) OX9MP03 (For OX903)**  
 38½"W x ¾"D x 14½"H  
 List: \$151.00

**OX9MP01 (For OX901 & OX9170)**  
 50¾"W x ¾"D x 14½"H  
 List: \$209.00

**C 63"W Open Side Return OX9180**  
 63"W x 21½"D x 25¾"H  
 List: \$907.00

**D Optional Sliding Doors (For OX9180) OX9WDS80\***  
 29½"W x ¾"D x 20⅞"H  
 List: \$282.00

**E Optional 2 Drawer Storage Doors (For OX9180) OX9DRW80\* (Set of 2)**  
 30½"W x 19¾"D x 20½"H  
 List: \$830.00



Open Side Return Adjustable Shelves

## ADDITIONAL PRODUCTS



**F Storage Credenza (w/B/B/F & Sliding Doors) OX9245**  
 47¼"W x 17¾"D x 29½"H  
 List: \$1,393.00

Note: PLLOCKCOREKIT does not work with OX9245.



Pictured w/Top Cushion

**Mobile Pedestal Box/File OX9007**  
 16"W x 22½"D x 22½"H  
 List: \$861.00

**Top Cushion CUSH1623 (For OX9007)**  
 List: \$237.00

### Top Cushion Upholstery Colors



BL Celestial Blue

GK Dark Gray

### Laminate Finishes



CG Coastal Gray

WH White

(\*Select SKUs)  
 (OX9WDS80 & OX9DRW80 Only)

Some items in this collection come ready-to-assemble.



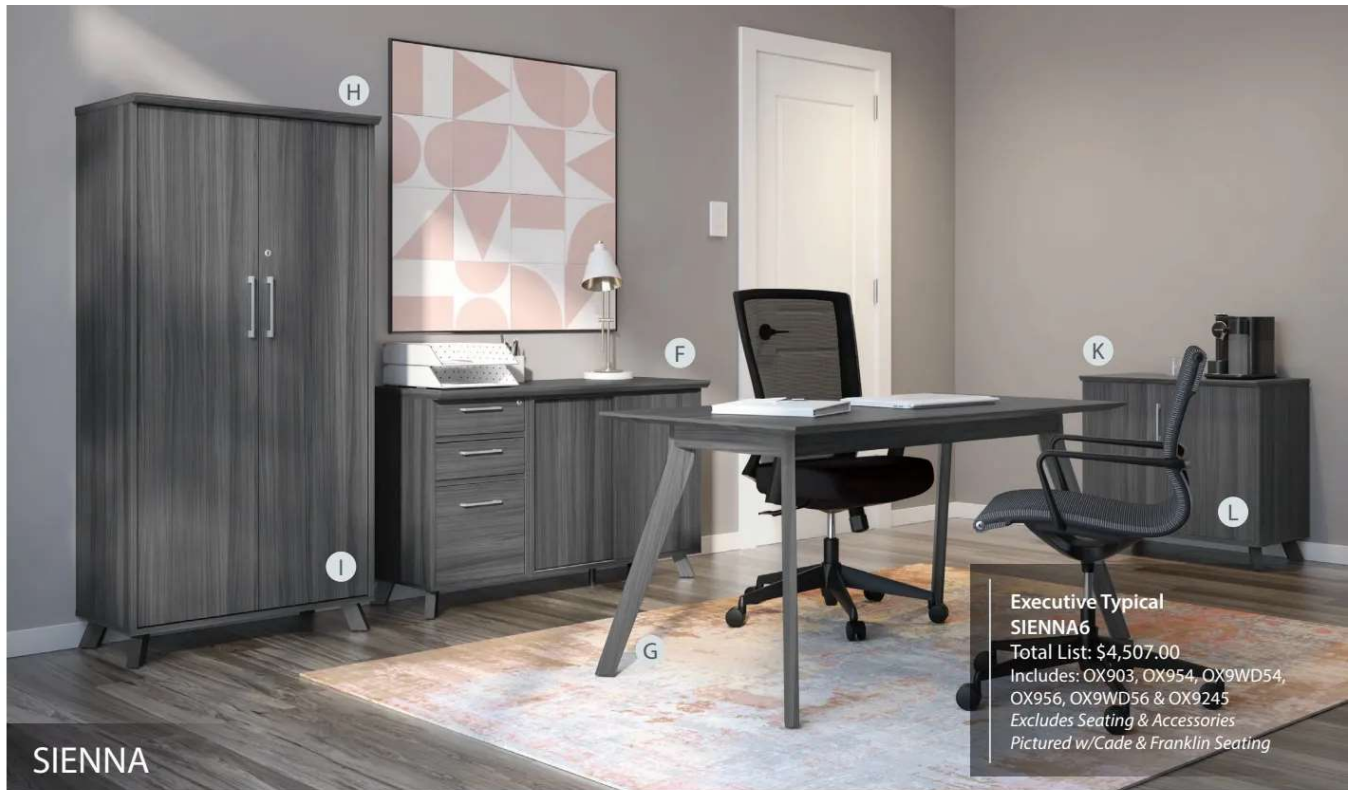

## SIENNA

### Executive Typical SIENNA6

Total List: \$4,507.00

Includes: OX903, OX954, OX9WD54,  
OX956, OX9WD56 & OX9245

Excludes Seating & Accessories

Pictured w/Cade & Franklin Seating

**G 60"W Desk (w/o Modesty)**  
**OX903**  
60"W x 29½"D x 29½"H  
List: \$949.00

**66"W Desk (w/o Modesty)**  
**OX902**  
66"W x 29½"D x 29½"H  
List: \$975.00

**71"W Desk (w/o Modesty)**  
**OX901**  
71"W x 29½"D x 29½"H  
List: \$1,021.00

**H Open Bookcase (No Doors)**  
**OX956**  
31½"W x 17¾"D x 65"H  
List: \$936.00

**K Open Bookcase (No Doors)**  
**OX954**  
31½"W x 17¾"D x 29½"H  
List: \$519.00

**N Glass Door Kits (Not Pictured)**  
**OX9GD56 (For OX956)**  
29½"W x ¾"D x 59"H  
List: \$1,050.00

**I Laminate Door Kits**  
*(For OX956)*  
**OX9WD56\***  
29½"W x ¾"D x 60"H  
List: \$472.00

**L Laminate Door Kits**  
*(For OX954)*  
**OX9WD54**  
31½"W x ¾"D x 24¾"H  
List: \$238.00

**O Lock Core Kit (Not Pictured)**  
**PLLOCKCOREKIT**  
List: \$50.00

Available in BK Black or SI Silver

**J 94"W Boat Shape  
Conference Table**  
*(w/Grommet)*

**OX9236**  
94½"W x 47¼"D x 29½"H  
List: \$1,874.00

**M 42" Round Meeting Table**  
*(Not Pictured)*

**OX9127**  
42"Dia x 29½"H  
List: \$944.00

Note: Please ask your Sales Rep  
about keying-alike or differently for  
the PLLOCKCOREKIT.



### L Shape Typical SIENNA7

Total List: \$3,330.00

Includes: OX9170, OX9180,  
OX9WDS80, OX9DRW80 & OX9MP01

Excludes Seating & Accessories

Pictured w/CoolMesh Basic Seating



Pictured w/Franklin Seating



**Executive Typical  
PALISADES1**

Total List: \$11,372.00  
108"W x 67½"H  
Includes: EV7230DP, EVC350,  
EV7224C, EVP400 & EVS100  
Excludes Seating & Accessories  
Pictured w/Palma Seating

**PALISADES**

**A 60"W Double Pedestal Desk  
EV6030DP**

60"W x 30"D x 29½"H  
List: \$3,305.00

**66"W Double Pedestal Desk  
EV6630DP**

66"W x 30"D x 29½"H  
List: \$3,349.00

**72"W Double Pedestal Desk  
EV7230DP**

72"W x 30"D x 29½"H  
List: \$3,455.00

**B Hutch w/Supports  
& Sliding Doors  
EVC350**

72"W x 15"D x 37¼"H  
List: \$1,872.00

**Wall Mounted Hutch  
w/Sliding Doors  
EVC300**

72"W x 15"D x 17¾"H  
List: \$1,609.00

**C Double Pedestal Credenza  
EV7224C**

72"W x 24"D x 29½"H  
List: \$2,963.00

**D 2 Drawer Lateral File  
EVP400**

36"W x 24"D x 29½"H  
List: \$1,989.00

**E 38"H Open  
Bookcase Hutch  
EVS100**

36"W x 15½"D x 38"H  
List: \$1,093.00

**F 67"H Open  
Bookcase Hutch  
EVS300**

36"W x 15½"D x 67"H  
List: \$1,745.00



Wall Mountable

**ADDITIONAL PRODUCTS**



**60"W Single Pedestal Desk  
EV6030SP**

60"W x 30"D x 29½"H  
List: \$2,716.00

**66"W Single Pedestal Desk  
EV6630SP**

66"W x 30"D x 29½"H  
List: \$2,760.00

**72"W Single Pedestal Desk  
EV7230SP**

72"W x 30"D x 29½"H  
List: \$2,866.00



**72"W Height Adjustable Desk  
EVH400**

72"W x 30"D x 29½-47¼"H  
List: \$4,417.00

**Mobile Pedestal  
Box/Box/File  
EVP300**

15½"W x 20"D x 24¾"H  
List: \$978.00



EVP300 - Mobile Pedestal  
Locking



GG Gauntlet Gray  
w/Graphite Metal



F





## PALISADES

### Executive Typical PALISADES7

Total List: \$14,635.00  
 144"W x 59"H  
 Includes: EV6030DP, EVP400  
 (2), EVS700 (2), EVS600 (2),  
 EVS620, EVS710 & EVC300  
 Excludes Seating & Accessories  
 Pictured w/Palma Seating

**G Storage Cabinet  
EVS700**  
 36"W x 24"D x 29½"H  
 List: \$1,364.00

**H Bookcase Hutch  
EVS600**  
 36"W x 24"D x 29½"H  
 List: \$1,093.00

**I Optional Laminate Doors  
(For use with EVS700)**  
**EVS710**  
 36"W x 24"D x 29½"H  
 List: \$279.00

**J Optional Glass Doors  
(For use with EVS700)**  
**EVS720**  
 36"W x 24"D x 29½"H  
 List: \$334.00

**K Optional Laminate Doors  
(For use with EVS600)**  
**EVS610**  
 36"W x 24"D x 29½"H  
 List: \$357.00

**L Optional Glass Doors  
(For use with EVS600)**  
**EVS620**  
 36"W x 24"D x 29½"H  
 List: \$550.00



Storage Cabinet  
Without Doors



Bookcase Hutch  
Without Doors

## ADDITIONAL PRODUCTS



**Coffee Table  
EVS550**  
 47¼"W x 23⅝"D x 17"H  
 List: \$1,148.00



**End Table  
EVS500**  
 20½"W x 20½"D x 26"H  
 List: \$826.00

## OPTIONAL POWER



**Optional Power Unit  
EVT1050**  
 (For Pedestal Desks)  
 List: \$234.00

Note: Use with the main  
pedestal unit of a single or  
double pedestal desk. EVT1050  
is **not** daisy chainable.

## UNIQUE PULL FEATURES



Modern graphite metal  
pulls complement the gray  
frame finish



GG Gauntlet Gray  
w/Graphite Metal



**PALISADES**

**Height Adjustable Typical PALISADES6**  
 Total List: \$9,323.00  
 72"W x 78"D x 29½-47¼"H  
 Includes: EVH200 & EV7224C  
 Excludes Seating & Accessories  
 Pictured w/Palma Seating

**K L Shape Electric Height Adjustable Desk w/Single Pedestal EVH200**  
 Overall: 72"W x 78"D x 29½"H  
 Desk: 72"W x 30"D x 29½"H  
 Return: 48"W x 24"D x 29½-47¼"H  
 List: \$6,360.00

*Note: Only the return is height adjustable.*

**L L Shape Electric Height Adjustable Desk EVH100**  
 Overall: 72"W x 78"D x 29½-47¼"H  
 Desk: 72"W x 30"D x 29½-47¼"H  
 Return: 48"W x 24"D x 29½-47¼"H  
 List: \$7,384.00

*Note: Desk and return are fully height adjustable.*



*Fully Height Adjustable*

**M L Shape Double Pedestal Desk w/Reversible Return EV6030L**  
 Overall: 60"W x 78"D x 29½"H  
 Desk: 60"W x 30"D x 29½"H  
 Return: 48"W x 24"D x 29½"H  
 List: \$4,377.00

**EV6630L**  
 Overall: 66"W x 78"D x 29½"H  
 Desk: 66"W x 30"D x 29½"H  
 Return: 48"W x 24"D x 29½"H  
 List: \$4,421.00

**EV7230L**  
 Overall: 72"W x 78"D x 29½"H  
 Desk: 72"W x 30"D x 29½"H  
 Return: 48"W x 24"D x 29½"H  
 List: \$4,527.00



*EVRC1R - User Side*

**Reception Desk (Desk Only)**  
**EVRC1L (Left)**  
**EVRC1R (Right)**  
 87½"W x 37"D x 47½"H  
 List: \$4,939.00

**Optional Reversible Return EVRC2**  
 47¼"W x 23¾"D x 41¼"H  
 List: \$950.00



*Pictured w/EVRC1L (Front Side)*



**GG Gauntlet Gray w/Graphite Metal**





**Executive Typical  
PALISADES**  
Total List: \$7,786.00  
72"W x 102"D x 67½"H  
Includes: EV7230U & EVC350  
Excludes Seating & Accessories  
Pictured w/Palma Seating

**PALISADES**

**N U Shape Double Pedestal Desk  
w/Reversible Bridge**  
**EV7230U**  
Overall: 72"W x 102"D x 29½"H  
Desk: 72"W x 30"D x 29½"H  
Bridge: 48"W x 24"D x 29½"H  
Credenza: 72"W x 24"D x 29½"H  
List: \$5,914.00

**FEATURES**

- Laminate is water, scratch, stain, fade & mildew resistant
- Pedestal desks include a full length mesh modesty panel for privacy
- Base frame is made from durable metal with a graphite finish



**PRODUCT FEATURES**

Laminate tops have a 1.65" thick PVC edge and floating look

Modern graphite pulls complement the frame finish completely

**CONFERENCE PRODUCTS**



**72"W Sitting Height  
Conference Table**  
(Pre-cut Grommet Insert + Cover)  
**EVT6**  
72"W x 47¼"D x 29¾"H  
List: \$2,814.00



**96"W Standing  
Height Table**  
(6 Cutouts for EVT900BK)  
**EVST8**  
95¼"W x 47¼"D x 42"H  
List: \$5,346.00



**42"W Round  
Conference Table**  
**EV42R**  
42"W x 42"D x 29¾"H  
List: \$1,215.00



GG Gauntlet Gray  
w/Graphite Metal  
Note: PLTBPOWER is an optional power insert option that fits EVT6, EVT8 & EVT10.

**96"W Sitting Height  
Conference Table**  
(2 Pre-cut Grommet Inserts + Covers)  
**EVT8** (Not Pictured)  
95¼"W x 47¼"D x 29¾"H  
List: \$2,943.00

**120"W Sitting Height  
Conference Table**  
(2 Pre-cut Grommet Inserts + Covers)  
**EVT10** (Not Pictured)  
120"W x 47¼"D x 29¾"H  
List: \$5,080.00



**OPTIONAL POWER**

**Daisy Chain Power Module**  
(For EVST8 Only)  
**EVT900BK** (Black Only)  
List: \$660.00

Note: Daisy chained up to (3) power modules only. Power modules are sold separately as a set of (3).





**EPITOME**

**Executive Typical  
EPITOME4**

Total List: \$6,232.00  
Includes: IDD3072, IDR3624,  
IDDMOD, HIL36 & IDPBF  
Excludes Accessories

**A 59"W Industrial Desk  
w/Metal Corners**  
(No Modesty Panel)  
**IDD3060**  
59½"W x 29½"D x 29½"H  
List: \$2,421.00

**B 35"W Industrial Return  
w/Metal Corners**  
**IDR3624**  
35¾"W x 23¾"D x 29½"H  
List: \$1,441.00

**C Metal Modesty Panel**  
**IDDMOD**  
52¾"W x ¾"D x 15¾"H  
List: \$365.00

**D 2 Drawer Lateral File**  
(Locking - from Riveted)  
**HIL36**  
35"W x 17¾"D x 29½"H  
List: \$1,140.00

**E Box/File Pedestal**  
(Locking)  
**IDPBF**  
15½"W x 19¾"D x 24"H  
List: \$715.00

**71"W Industrial Desk  
w/Metal Corners**  
(No Modesty Panel)  
**IDD3072**  
70¾"W x 29½"D x 29½"H  
List: \$2,571.00

**41"W Industrial Return  
w/Metal Corners**  
**IDR4224**  
41¾"W x 23¾"D x 29½"H  
List: \$1,245.00

**47"W Industrial Return  
w/Metal Corners**  
**IDR4824**  
47¼"W x 23¾"D x 29½"H  
List: \$1,294.00

*Riveted Lateral File  
Pairs Well With Epitome*



*Includes A Single Lock  
For All Drawers*



*59"W Industrial Desk  
Shown without Optional Metal Modesty Panel*

**UNIQUE PULL  
FEATURE**



*Black metal pulls  
offers a more rustic,  
industrial look*



**DB Distressed Brown  
w/Distressed Charcoal**



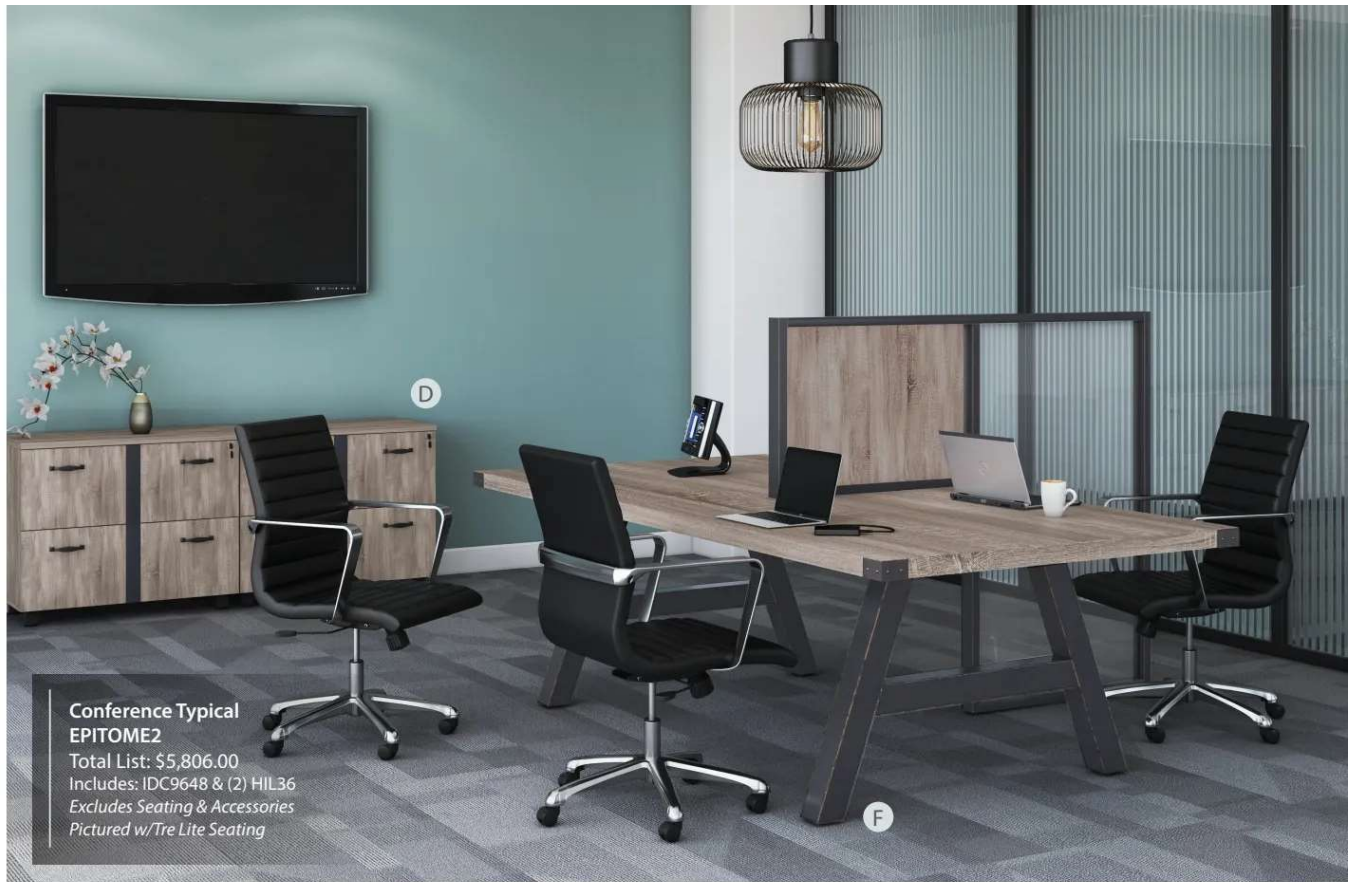

**Conference Typical  
EPITOME2**  
 Total List: \$5,806.00  
 Includes: IDC9648 & (2) HIL36  
 Excludes Seating & Accessories  
 Pictured w/Tre Lite Seating

## EPITOME

**F 94"W Conference Table  
IDC9648**  
 94<sup>3</sup>/<sub>8</sub>"W x 47<sup>1</sup>/<sub>2</sub>"D x 29<sup>1</sup>/<sub>2</sub>"H  
 List: \$3,526.00



*Pairs Well With  
the Riveted*



*Profile View*



*Front View*



**PRODUCT FEATURES**

*Industrial, sleek metal framework on corners with exposed hardware*



*Durable, A-Frame style metal legs with a distressed charcoal finish*



**DB Distressed Brown  
w/Distressed Charcoal**



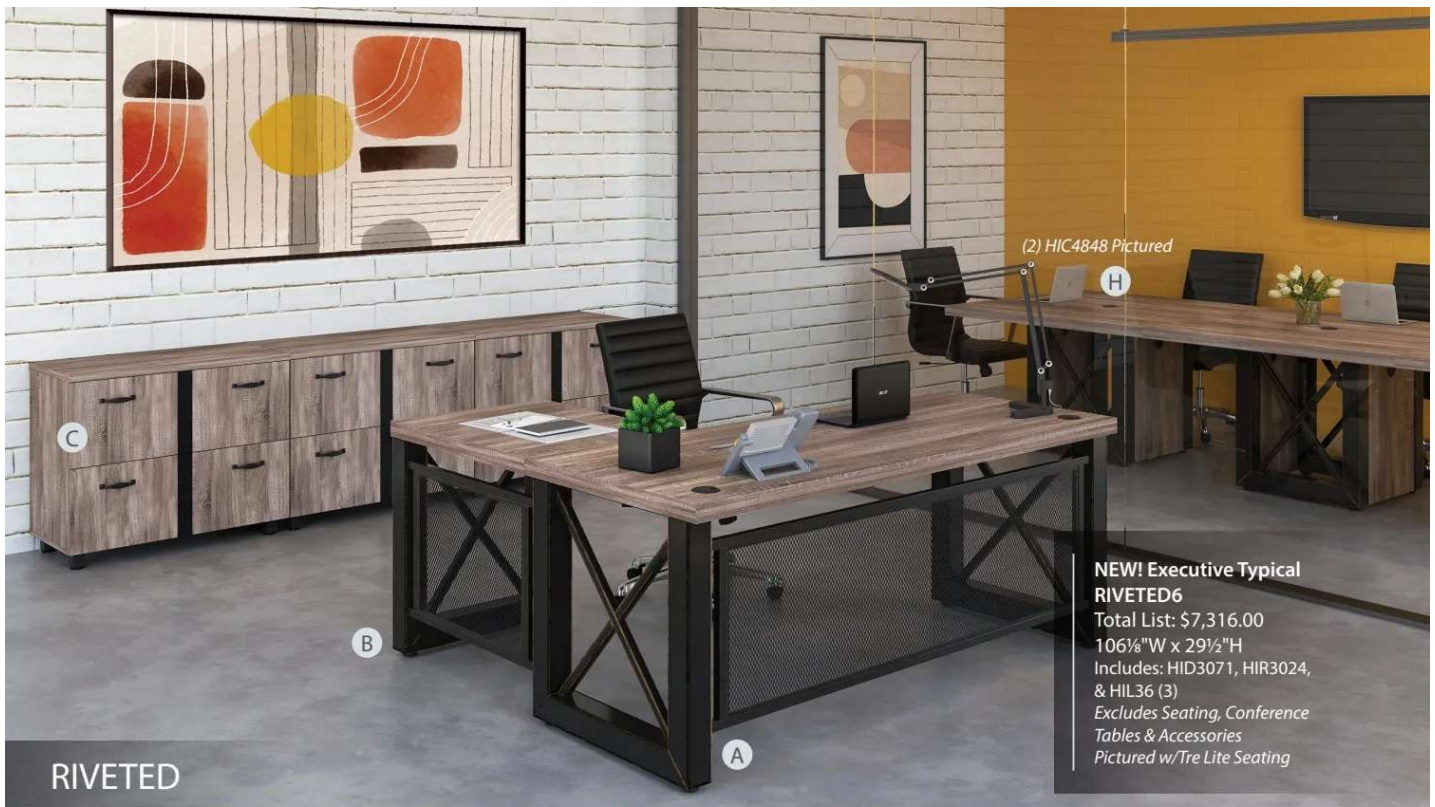

(2) HIC4848 Pictured

**NEW! Executive Typical RIVETED6**  
 Total List: \$7,316.00  
 106½"W x 29½"H  
 Includes: HID3071, HIR3024, & HIL36 (3)  
 Excludes Seating, Conference Tables & Accessories  
 Pictured w/Tre Lite Seating

RIVETED

**A 59"W Industrial Desk w/Metal X Base**  
 (Bottom Modesty Included)  
**HID3060**  
 59½"W x 29½"D x 29½"H  
 List: \$2,340.00

**71"W Industrial Desk w/Metal X Base**  
 (Bottom Modesty Included)  
**HID3071**  
 70¾"W x 29½"D x 29½"H  
 List: \$2,378.00

**B 29½"W Industrial Return w/Metal X Base**  
 (Bottom Modesty Included)  
**HIR3024**  
 29½"W x 23½"D x 29½"H  
 List: \$1,518.00

**41"W Industrial Return w/Metal X Base**  
 (Bottom Modesty Included)  
**HIR4124**  
 41¾"W x 23½"D x 29½"H  
 List: \$1,599.00

**C 2 Drawer Lateral File HIL36**  
 35¾"W x 17¾"D x 29½"H  
 List: \$1,140.00

*HIR3024 - Profile View*  
 Includes Bottom Modesty Panel



*59"W Industrial Desk Comes With Two Grommets*



DB Distressed Brown w/Distressed Charcoal

Some items in this collection come ready-to-assemble.

## FEATURES

- Heavy-duty, industrial metal cross-bar base with a distressed charcoal finish
- Desks include a bottom mesh, metal modesty panel for optimal privacy
- 2" Thick, distressed laminate tops
- Black metal pulls offers a more rustic, industrial look

## NEED ADDITIONAL STORAGE?

(from the Epitome)



**Box/File Pedestal (Locking)**  
**IDPBF**  
 15½"W x 19½"D x 24"H  
 List: \$715.00



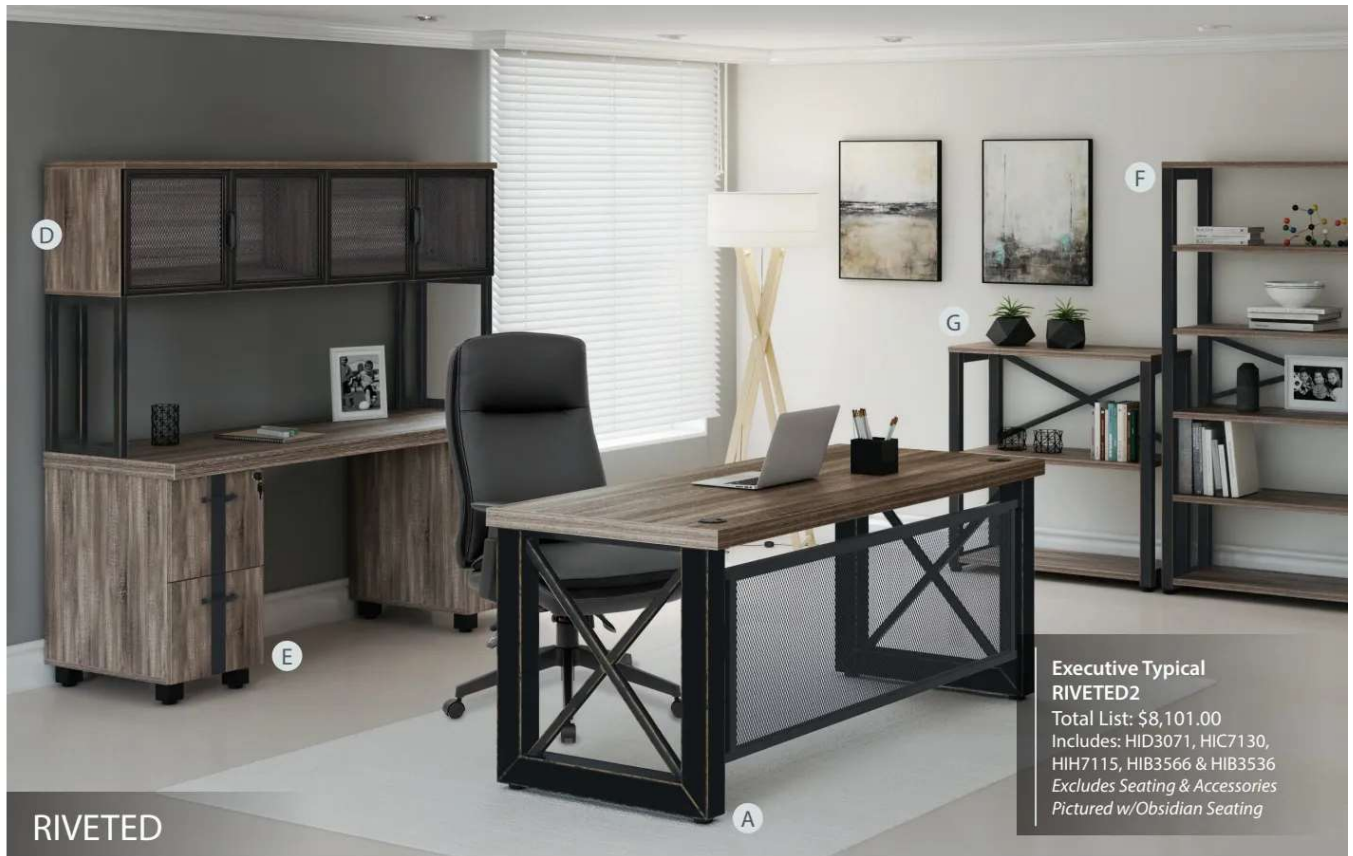

**RIVETED**

**Executive Typical RIVETED2**  
 Total List: \$8,101.00  
 Includes: HID3071, HIC7130, HIH7115, HIB3566 & HIB3536  
 Excludes Seating & Accessories  
 Pictured w/Obsidian Seating

**D Hutch w/Doors HIH7115**  
 70 $\frac{7}{8}$ "W x 14 $\frac{3}{4}$ "D x 36 $\frac{3}{8}$ "H  
 List: \$1,584.00

**E Double Pedestal Credenza HIC7130**  
 70 $\frac{7}{8}$ "W x 23 $\frac{3}{8}$ "D x 29 $\frac{1}{2}$ "H  
 List: \$2,181.00

**F 66"H Metal Bookcase HIB3566**  
 35 $\frac{3}{8}$ "W x 15 $\frac{3}{4}$ "D x 66 $\frac{1}{8}$ "H  
 List: \$1,225.00

**G 36"H Metal Bookcase HIB3536**  
 35 $\frac{3}{8}$ "W x 15 $\frac{3}{4}$ "D x 36 $\frac{3}{8}$ "H  
 List: \$733.00

**H Square Conference Table w/Cubed Base HIC4848**  
 47 $\frac{1}{4}$ "W x 47 $\frac{1}{4}$ "D x 29 $\frac{1}{2}$ "H  
 List: \$1,969.00



HIC7130 - Front View  
 Includes Two Locking Top Drawers

**NEW! Conference Typical RIVETED5**  
 Total List: \$5,885.00  
 Includes: HIC4848, HIB3566 (2) & HIB3536 (2)  
 Excludes Accessories



DB Distressed Brown w/Distressed Charcoal

Some items in this collection come ready-to-assemble.





**RALEIGH**

*Pictured in Walnut w/Black*

**A 60"W Double Pedestal Steel Desk**  
**QSOSDP6030**  
 60"W x 30"D x 29½"H  
 List: \$2,864.00

**B Steel Bookcase - 4 Shelves**  
**QSOSB4SLF60**  
 34½"W x 13"D x 60"H  
 List: \$1,098.00  
*See Page 219 For Additional Steel Bookcase Sizes*

**C 66"W Single Right Pedestal Desk**  
**QSOSSP6630**  
 66"W x 30"D x 29½"H  
 List: \$2,832.00

**48"W Single Right Pedestal Desk**  
**QSOSSP4830**  
 48"W x 30"D x 29½"H  
 List: \$2,456.00

**45"W Single Right Pedestal Desk**  
**QSOSSP4524**  
 45"W x 24"D x 29½"H  
 List: \$2,290.00



*Pictured in Walnut w/Black*

**ADDITIONAL PRODUCTS**



**42"W Single Pedestal Steel Return**  
**QSOSR4224**  
 42"W x 24"D x 29½"H  
 List: \$2,006.00



PO Oak w/Putty

BW Walnut w/Black

CM Mahogany w/Charcoal

**PRODUCT FEATURES**

*Center drawer has core-removable locks with a central locking system*



*Fully extending file & box pedestal drawers with precision ball-bearing suspension*

**QS = QUICKSHIP**

Items in this collection come fully assembled.





## BEDFORD

*Pictured in Mahogany w/Charcoal*

**A 72"W Double Pedestal Desk**  
**QSOSMD7236**  
 72"W x 36"D x 29½"H  
 List: \$4,170.00

**60"W Double Pedestal Desk**  
**QSOSMD6030**  
 60"W x 30"D x 29½"H  
 List: \$3,663.00

**B 72"W Double Pedestal Credenza**  
**QSOSMCD7224**  
 72"W x 24"D x 29½"H  
 List: \$3,622.00

**60"W Double Pedestal Credenza**  
**QSOSMCD6024**  
 60"W x 24"D x 29½"H  
 List: \$3,556.00

### FEATURES

- Durable, 1½" thick laminate work surface top
- Full-height end panels with leveling glides included
- Wire management grommets included
- Precision, ball-bearing suspensions with full extension file & box drawers
- Core-removable locks included

### ADDITIONAL PRODUCTS

**72"W Single Right Pedestal Credenza**  
**QSOSMC7224**  
 72"W x 24"D x 29½"H  
 List: \$3,385.00

**48"W Single Right Pedestal Desk**  
**QSOSMS4830**  
 48"W x 30"D x 29½"H  
 List: \$3,127.00

**48"W Single Right Pedestal Return**  
**QSOSMR4824**  
 48"W x 24"D x 29½"H  
 List: \$2,855.00



BW Walnut w/Black

CM Mahogany w/Charcoal

**QS = QUICKSHIP**

Items in this collection come fully assembled.

## WHITLEY



*Pictured in Walnut w/Black*

**A 60"W Mobile Double Pedestal Teacher's Desk**  
**QSOSTDM6030**  
 60"W x 30"D x 29½"H  
 List: \$3,099.00



WP White w/Platinum

**B 48"W Mobile Single Pedestal Teacher's Desk**  
**QSOSTSM4830**  
 48"W x 30"D x 29½"H  
 List: \$2,550.00



BW Walnut w/Black



**QS = QUICKSHIP**

Items in this collection come fully assembled.



ELEVATE YOUR MODERN OFFICE  
WITH OUR BEST-SELLING  
OS LAMINATE COLLECTION

*Pictured w/Oslo Seating & OS269 Typical*

Now Available in the New! Finish - American Elm



*Pictured w/Palma Seating  
& NEW! OSTYP306 Typical*

**FEATURES**



*Standard Black  
Wire Grommets*



*Standard Silver  
Crescent Pulls*



*Beautiful  
Wood Grain*

*Experience the transformative power of American Elm,  
where we redefine what an office can be.*

This exceptional line offers a wide array of components and sizes, allowing you to effortlessly customize your workspace to meet your every need.



Uplift your workplace to new heights, where creativity thrives, and productivity soars.





**OS LAMINATE**  
**NEW! American Elm Finish**

**NEW FINISH! U Shape Typical OS268†**  
 Total List: \$4,300.00  
 106½"W x 95"D x 65½"H  
 Excludes Seating & Accessories  
 Pictured w/Palma Seating



**NEW FINISH! OS127 | Components**

SKU #	QTY	DESCRIPTION	W x D x H
PL101†	1	Desk Shell	71 x 35½ x 29½
PL145†	1	Reversible Return	47 x 24 x 29½
PL166†	1	Deluxe Full Pedestal - B/B/F	15½ x 22 x 28½
PL175†	1	Deluxe Full Pedestal - F/F	15½ x 22 x 28½
PL144OH†	1	Open Hutch	71 x 15 x 36
PL44SLIDESGD	2	Sliding Glass Doors (Sets of 2)	18 x ½ x 15¾
PL44RAIL	1	Rails For Glass Doors	69 x 1 x 1
PL118	1	Tack Board (Visconti Fabric)	68¾ x ½ x 16½

**NEW FINISH! L Shape Typical OS127†**  
 Total List: \$4,522.00  
 71"W x 83"D x 65½"H  
 Excludes Seating & Accessories  
 Pictured w/Palma Seating

**NEW FINISH! OS268 | Components**

SKU #	QTY	DESCRIPTION	W x D x H
PL101†	1	Desk Shell	71 x 35½ x 29½
PL193†	1	Bridge	35 x 24 x 29½
PL143†	1	Credenza Shell	71 x 24 x 29½
PL112†	1	Two Drawer Lateral File	35½ x 22 x 29½
PL144OH†	1	Open Hutch	71 x 15 x 36
PL44LD†	2	Laminate Hutch Doors (Set of 2)	17 x ¾ x 15¾
PL118	1	Tack Board (Gray Fabric)	68¾ x ½ x 16½

**Standard Pull Options**

Customize Your Pull Options - See Page 35



**NEW! AE American Elm** w/Silver Pulls  
 (†Select SKUs)

**CG Coastal Gray** w/Silver Pulls

**ES Espresso** w/Silver Pulls



**MW Modern Walnut** w/Silver Pulls

**MH Mahogany** w/Black Pulls

**CH Cherry** w/Black Pulls



**WH White** w/Silver Pulls

**MA Maple** w/Black Pulls



**OS LAMINATE**  
**NEW! American Elm Finish**

**NEW FINISH! U Shape Typical OS21†**

Total List: \$7,350.00  
 106½"W x 112"D x 65½"H  
 Excludes Seating & Accessories  
 Pictured w/Palma Seating



**NEW! OSTYP306 | Components**

SKU #	QTY	DESCRIPTION	W x D x H
PL189†	1	Bow Front Desk Shell	71 x 36/41 x 29½
PL170†	1	Bridge	47 x 24 x 29½
PL143†	1	Credenza Shell	71 x 24 x 29½
PL166†	1	Deluxe Full Pedestal - B/B/F	15½ x 22 x 28½
PL112†	2	Two Drawer Lateral File	35½ x 22 x 29½
PL152†	2	Storage Cabinet	35½ x 22 x 37¼
PL144OH†	1	Open Hutch	71 x 15 x 36
PL44LD†	2	Laminate Hutch Doors (Set of 2)	17 x ¾ x 15¾
PL118	1	Tack Board (Gray Fabric)	68½ x ½ x 16½

**NEW! U Shape Typical OSTYP306†**

Total List: \$8,618.00  
 142"W x 112"D x 65½"H  
 Excludes Seating & Accessories  
 Pictured w/Palma Seating

**NEW FINISH! OS21 | Components**

SKU #	QTY	DESCRIPTION	W x D x H
PL189†	1	Bow Front Desk Shell	71 x 36/41 x 29½
PL170†	1	Bridge	47 x 24 x 29½
PL143†	1	Credenza Shell	71 x 24 x 29½
PL166†	1	Deluxe Full Pedestal - B/B/F	15½ x 22 x 28½
PL144OH†	1	Open Hutch	71 x 15 x 36
PL44SGD	1	Silver Frame Glass Doors (Sets of 2)	17 x ¾ x 15¾
PL112†	1	Two Drawer Lateral File	35½ x 22 x 29½
PL152†	1	Storage Cabinet	35½ x 22 x 37¼
PL152SGD	1	Silver Frame Glass Cabinet Doors	17½ x ½ x 36¼
GBM1769	1	Magnetic Glass White Board	68½ x ½ x 16½

**Standard Pull Options**

Customize Your Pull Options - See Page 35



**NEW! AE American Elm** w/Silver Pulls  
 (†Select SKUs)

**CG Coastal Gray** w/Silver Pulls

**ES Espresso** w/Silver Pulls



**MW Modern Walnut** w/Silver Pulls

**MH Mahogany** w/Black Pulls

**CH Cherry** w/Black Pulls



**WH White** w/Silver Pulls

**MA Maple** w/Black Pulls





OS LAMINATE  
NEW! American Elm Finish

**NEW! U Shape Typical OSTYP307†**  
Total List: \$4,432.00  
71"W x 101"D x 65½"H  
Excludes Seating & Accessories  
Pictured w/Palma Seating



**NEW FINISH! OS86 | Components**

SKU #	QTY	DESCRIPTION	W x D x H
PL101†	1	Desk Shell	71 x 35½ x 29½
PL145†	1	Reversible Return	47 x 24 x 29½
PL166†	1	Deluxe Full Pedestal - B/B/F	15½ x 22 x 28½
PL175†	1	Deluxe Full Pedestal - F/F	15½ x 22 x 28½
PL144OH†	1	Open Hutch	71 x 15 x 36
PL44LD†	1	Laminate Hutch Doors (Set of 2)	17 x ¾ x 15¾
PL118	1	Tack Board (Gray Fabric)	68⅞ x ½ x 16½

**NEW FINISH! L Shape Typical OS86†**  
Total List: \$3,943.00  
71"W x 83"D x 65½"H  
Excludes Seating & Accessories  
Pictured w/Palma Seating

**NEW! OSTYP307 | Components**

SKU #	QTY	DESCRIPTION	W x D x H
PL143†	1	Credenza Shell	71 x 24 x 29½
PL114†	1	Combo Lateral File - B/B/F/Lat.	31 x 22 x 29½
PL144OH†	1	Open Hutch	71 x 15 x 36
PL44LD†	1	Laminate Hutch Doors (Set of 2)	17 x ¾ x 15¾
PL170†	1	Bridge	47 x 24 x 29½
PL105†	1	Desk Shell	71 x 30 x 29½
PL118	1	Tack Board (Gray Fabric)	68⅞ x ½ x 16½

**Additional Pull Options**  
Customize Your Pull Options - See Page 35





## OS LAMINATE

Pictured w/Cade Seating & OS170 Typical



NEW! AE American Elm  
(†Select SKUs)

CG Coastal Gray

ES Espresso

MW Modern Walnut

MH Mahogany

CH Cherry

WH White  
(Select SKUs)

MA Maple  
(Select SKUs)

Note: American Elm only available for select SKUs. Select SKUs are notated by a † mark at the end of their SKU.

### A Desk Shell - 29½"H

PL104†	47"W x 24"D x 29½"H	\$497.00
PL121†	47"W x 30"D x 29½"H	\$533.00
PL103†	60"W x 30"D x 29½"H	\$541.00
PL102†	66"W x 30"D x 29½"H	\$585.00
PL105†	71"W x 30"D x 29½"H	\$726.00
PL101†	71"W x 36"D x 29½"H	\$739.00

### B Desk Shell w/Corner Extension - 29½"H

PL178R† (Rt)	71"W x 30/42"D x 29½"H	\$1,174.00
PL178L† (Lt)	71"W x 30/42"D x 29½"H	\$1,174.00

### C End Panel Leg (For Bullet Tops)

PLTEP30	30"W (For PLT131T)	\$289.00
PLTEP36	36"W (For PLT147T)	\$338.00

### D Half Gable (For End Panel or Credenza Shell)

PL142†*	12¾"W x 1"D x 28"H	\$104.00
---------	--------------------	----------

\*Note: PL142 replaces the full gable so that a credenza shell can be used in a return application.

### E Credenza Shell - 29½"H

PL129†	60"W x 24"D x 29½"H	\$547.00
PL111†	66"W x 24"D x 29½"H	\$562.00
PL143†	71"W x 24"D x 29½"H	\$593.00

### F Bullet Tops (Tops Only - Must Order Leg, Half Gable & End Panel)

PLT131T	66"W x 30"D x 1"H	\$472.00
PLT147T	72"W x 36"D x 1"H	\$578.00

PLT131T is available in ES Espresso, MA Maple, MW Modern Walnut & CG Coastal Gray Only.

PLT147T is available in ES Espresso, MA Maple, MW Modern Walnut & CG Coastal Gray Only.

### G Post Leg (For PLT131T & PLT147T Only)

OS720	Single Post Leg	\$235.00
-------	-----------------	----------

Available in BK Matte Black or SI Silver

Note: OS720 can be shipped by a small package carrier.

### H Corner Desk Shell - 29½"H

PL134	42"W x 42"D x 29½"H	\$776.00
PL163	36"W x 36"D x 29½"H	\$880.00

PL134 & PL163 are available in CH Cherry, MH Mahogany, ES Espresso, MW Modern Walnut & CG Coastal Gray Only.

### I Reversible Return - 29½"H

PL194†	24"W x 24"D x 29½"H	\$344.00
PL179†	30"W x 24"D x 29½"H	\$359.00
PL198	35"W x 20"D x 29½"H	\$377.00
PL192†	35"W x 24"D x 29½"H	\$377.00
PL146†	42"W x 20"D x 29½"H	\$487.00
PL196†	42"W x 24"D x 29½"H	\$487.00
PL145†	47"W x 24"D x 29½"H	\$501.00

Note: PL194 & PL179 do not have grommets.

## ADDITIONAL PRODUCTS



### Bow Front Desk Shell - 29½"H

PL187†	66"W x 30/35½"D x 29½"H	\$946.00
PL189†	71"W x 36/41"D x 29½"H	\$946.00

### Bow Front Desk Shell w/Corner Ext. - 29½"H

PL177R (Rt)	71"W x 30/36/42/48"D x 29½"H	\$1,174.00
PL177L (Lt)	71"W x 30/36/42/48"D x 29½"H	\$1,174.00



### Credenza w/Corner Extension - 29½"H

PL181R† (Rt)	66"W x 24/36"D x 29½"H	\$845.00
PL181L† (Lt)	66"W x 24/36"D x 29½"H	\$845.00
PL182R† (Rt)	71"W x 24/36"D x 29½"H	\$859.00
PL182L† (Lt)	71"W x 24/36"D x 29½"H	\$859.00

PL177R & PL177L are available in CH Cherry, ES Espresso, MH Mahogany, MW Modern Walnut, CG Coastal Gray & WH White Only.



### Bridge - 29½"H

PL188	30"W x 24"D x 29½"H	\$341.00
PL193†	35"W x 24"D x 29½"H	\$344.00
PL197†	42"W x 24"D x 29½"H	\$368.00
PL170†	47"W x 24"D x 29½"H	\$411.00



**PULL OPTIONS**



**Crescent Pull  
OSPULLHL**  
List: \$46.00 ea.  
*SI Silver or BK Black*



**Rectangular Pull  
OSPULLR**  
List: \$46.00 ea.  
*SI Silver*



**Modern Metro Pull  
OSPULLCYL**  
List: \$46.00 ea.  
*SI Silver, BK Black  
or GR Gray*



**Modern Bar Pull  
OSPULLBAR**  
List: \$46.00 ea.  
*SI Silver or BK Black*



**Mid-Century Pull  
OSPULLMC**  
List: \$46.00 ea.  
*SI Silver, BK Black  
or GR Gray*



**STEP FRONT DESKS**



**A Bow Top w/Modesty Panel  
PL489†\*** 71"W x 35½/41"D \$761.00

**B Glass Modesty Panel (For PL401 & PL489)  
PL71SGM** 40"W x 28"H \$724.00  
*Available in FR Frosted Glass*

**C False Pedestals  
PL46836†\*\*** 15¾"W x 35½"D x 28½"H \$472.00  
*(For PL401 & PL489)*  
**\*\*Note:** (2) False pedestals are required under **PL401 & PL489**.

**D Desk Top w/Modesty Panel  
PL401\*** 71"W x 35½"D \$625.00

**\*Note:** Step front desk tops require (2) false pedestals for support.

*All work surfaces are 29½"H. Top Thickness: (PL) 1" Thick. Measurements are approximate as they are rounded up to the next full inch.*



**NEW! AE American Elm** (†Select SKUs)

**CG Coastal Gray**

**ES Espresso**

*Note: American Elm only available for select SKUs. Select SKUs are notated by a † mark at the end of their SKU.*

**STANDING HEIGHT DESKS**



**Standing Table - 41"H  
PLT4172†** 72"W x 30"D x 41¾"H \$1,266.00

**Note:** *PLT4172 is not compatible with attachable pedestals.*



**NEW! AE American Elm** (†Select SKUs)

**CG Coastal Gray**



**ES Espresso**

**MW Modern Walnut**



**WH White**

*Pictured w/Rise Seating - See Page 169*

# OS LAMINATE

## HUTCHES WITH LAMINATE DOORS



**Hutch w/Laminate Doors**  
**PL125** 47¼"W x 15"D x 36"H \$915.00  
 Note: PL125 is not available in WH White.



**OPTIONAL TACK BOARDS**  
 Add a fabric tack board for an easy solution to post messages and reminders while you work

## HUTCHES WITHOUT DOORS



**Open Hutch - 15" Depth**  
**PL141OH†** 60"W x 15"D x 36"H \$802.00  
**PL140OH†** 66"W x 15"D x 36"H \$830.00  
**PL144OH†** 71"W x 15"D x 36"H \$851.00

**Wall Mounted Open Hutch**  
**PL209OH** 31"W x 15"D x 17"H \$519.00  
**PL208OH†** 36½"W x 15"D x 17"H \$562.00  
**PL2044OH†** 71"W x 15"D x 17"H \$946.00



**Open Hutch - 14" Depth**  
**PL153†** 35½"W x 14"D x 36"H \$608.00



**Open Hutch (Requires Supports)**  
**PL1044OH†** 71"W x 15"D x 17"H \$950.00  
 Note: PL1044OH can not be wall mounted.

**Hutch Supports (Sold as Pair)**  
**PLTLPHS20** 20"H \$341.00  
**PLTLPHS27** 27"H \$405.00

Available in BK Matte Black or SI Silver  
 Note: Hutch Supports are only for PL1044OH & cannot work with wall mounted units.

## OPTIONAL HUTCH ACCESSORIES



**Fabric Tack Boards**  
**PL115** (Fits PL141) 58"W x ½"D x 16½"H \$315.00  
**PL116** (Fits PL125) 45¼"W x ½"D x 16½"H \$299.00  
**PL117** (Fits PL140) 64"W x ½"D x 16½"H \$330.00  
**PL118** (Fits PL144) 68¾"W x ½"D x 16½"H \$359.00

**Magnetic Glass White Board**  
**GBM1769** (Fits PL144) 68½"W x ½"D x 16½"H \$445.00



Note: American Elm only available for select SKUs. Select SKUs are notated by a † mark at the end of their SKU.



# OS LAMINATE



Note: Hutch doors come in Sets of 2. This allows the hutch to have a partial open storage. If you want a fully closed storage hutch, you will need (2) door kits.

## OPTIONAL DOOR KITS FOR OPEN HUTCHES



### Optional Laminate Doors (Set of 2)

<b>PL40LD†</b>	(For PL140)	\$82.00
<b>PL41LD†</b>	(For PL141 & PL209)	\$80.00
<b>PL44LD*†</b>	(See Below)	\$83.00

\*Note: PL44LD is for PL144OH, PL208OH & PL2044OH.



### Optional Silver Framed Glass Doors (Set of 2)

<b>PL40SGD</b>	(For PL140)	\$373.00
<b>PL41SGD</b>	(For PL141 & PL209)	\$373.00
<b>PL44SGD*</b>	(See Below)	\$373.00

\*Note: PL44SGD is for PL144OH, PL208OH & PL2044OH.



### Optional Sliding Glass Doors

<b>PL44SLIDESGD*</b>	(See Below)	\$256.00
<b>PL44RAIL**</b>	(See Below)	\$150.00

Available in SI Silver

Note: PL44SLIDESGD & PL44RAIL is for PL144OH & PL2044OH.

\*Doors only, you must order rails.

\*\*Requires (1) PL44RAIL per (2) PL44SLIDESGD.



**OPTIONAL HUTCH LOCK**  
**Hutch Door Lock**  
**PLLDLOCKKIT**  
 List: \$59.00 ea.  
 Available in BK Black or SI Silver



Optional Sliding Glass Doors - OS127 Typical  
 Complements Well With NEW! American Elm Finish & Optional Black Pulls



Optional Laminate Doors - OS269 Typical  
 Complements Well With NEW! American Elm Finish & Silver Pulls



NEW! AE American Elm CG Coastal Gray ES Espresso MW Modern Walnut MH Mahogany CH Cherry WH White MA Maple  
 (†Select SKUs)

Note: American Elm only available for select SKUs. Select SKUs are notated by a † mark at the end of their SKU.



**OS LAMINATE**

*Pictured w/Bradley & Tre Seating & OS21 Typical*

- A Storage Cabinet**  
**PL113†**  
 35½"W x 22"D x 29½"H  
 List: \$726.00
- PL152†**  
 35½"W x 22"D x 37¼"H  
 List: \$1,050.00
- PL151†**  
 35½"W x 22"D x 65½"H  
 List: \$1,733.00

- B 2 Drawer Lateral File**  
**PL112†**  
 35½"W x 22"D x 29½"H  
 List: \$1,248.00

- C Credenza Top**  
**PL110†**  
 71"W x 22"D x 1"H  
 List: \$325.00
- PL110 sits on top of/can be applied to (2) PL112, (2) PL172, PL113, PL1012, PL2013 or PL152.*

- D Tempered Glass Silver Framed Cabinet Doors**  
**PL152SGD** (Set of 2 - For PL152)  
 List: \$737.00

- PL113SGD** (Set of 2 - For PL113)  
 List: \$432.00

*Available in FR Frosted Glass*

*Some items in this collection come ready-to-assemble.*

- E Deluxe Full Pedestal**  
**PL166†** (Box/Box/File)  
 15½"W x 22"D x 28½"H  
 List: \$696.00

- Deluxe Full Pedestal**  
**PL175†** (File/File)  
 15½"W x 22"D x 28½"H  
 List: \$714.00

- Top Panel**  
**PL66T†** (For PL166 & PL175)  
 16"W x 22"D x 1"H  
 List: \$110.00

**ADDITIONAL PRODUCTS**



- Combo Lateral File**  
**PL114†** (Box/Box/File w/Drawer)  
 31"W x 22"D x 29½"H \$1,409.00

- Buffet Credenza** (Top Drawer & Doors)  
**PL172†**  
 35½"W x 22"D x 37¼"H \$1,696.00

- Wardrobe Unit** (2 Drawer & Coat Rod)  
**PL207†**  
 24¼"W x 23¾"D x 65½"H \$2,507.00

- Personal Unit** (4 Adj. Shelves & Coat Rod)  
**PL150**  
 17¾"W x 23¾"D x 65½"H \$1,329.00



- 3 Drawer Lateral File**  
**PL183†**  
 35½"W x 22"D x 42"H \$2,948.00

- 4 Drawer Lateral File**  
**PL184†**  
 35½"W x 22"D x 54½"H \$3,612.00

- 31½"W Bookcases**  
**PL154†** 14"D x 29½"H \$359.00  
**PL155†** 14"D x 47¼"H \$472.00  
**PL156†** 14"D x 71"H \$670.00

- Optional Door Kit** (For Bookcases)  
**PLBCDK†** 16"W x ¾"D x 26"H \$253.00

*Casters Hidden Behind Laminate*  
 (For PL148 & PL149)



- Mobile Pedestals**  
**PL148†** (Box/Box/File)  
 16"W x 22½"D x 28½"H \$946.00

- PL149** (File/File)  
 16"W x 22½"D x 28½"H \$988.00

- PL1007†** (Box/File)  
 16"W x 22½"D x 22½"H \$769.00

- Optional Top Cushion**  
**CUSH2136** (For PL112 & PL113) \$445.00  
**CUSH1623** (For PL1007) \$237.00



- 3/4" Hanging Pedestals**  
**PL107†** (Box/File)  
 15½"W x 22"D x 19"H \$501.00

- PL108†** (Box/File)  
 15½"W x 19"D x 19"H \$501.00  
 (For use with PL146 & PL198)

- Corner Bookcases**  
**PL161** 15"W x 36"H \$519.00  
**PL160** 24"W x 29½"H \$716.00

*Note: PL161 & PL160 are not available in MA Maple or WH White.*

*Note: PL150151SGD - (1) Per Box, Order (2) for complete coverage on PL151.*

**OPTIONAL CORES & KEYS**



- Lock Core Kit** (Set of 2)  
**PLLOCKCOREKIT**  
 List: \$50.00



- Master Key**  
**PLMKEY**  
 List: \$31.00



- Blank Key** (Set of 2)  
**PLKEYBLANK**  
 List: \$29.00

*Note: Please ask your Sales Rep about keying-alike or differently for PLLOCKCOREKIT.*

*Note: PLMKEY, PLLOCKCOREKIT & PLKEYBLANK can be shipped by a small package carrier.*



*Shown w/PL110 on top of (2) PL172*

*Note: American Elm only available for select SKUs. Select SKUs are notated by a † mark at the end of their SKU.*



# OS LAMINATE

## DESK PACKAGES

### Single Pedestal Desk Packages

- 3/4 Pedestal, (1) PL107



<b>SGLHDPL104†</b>	48"W x 24"D	\$998.00
<b>SGLHDPL121†</b>	48"W x 30"D	\$1,034.00
<b>SGLHDPL103†</b>	60"W x 30"D	\$1,042.00
<b>SGLHDPL102†</b>	66"W x 30"D	\$1,086.00
<b>SGLHDPL105†</b>	71"W x 30"D	\$1,227.00
<b>SGLHDPL101†</b>	71"W x 36"D	\$1,240.00



### Single Pedestal "L" Desk Packages

- 24" x 47" Return, (1) PL145

- 3/4 Pedestal, (1) PL107

<b>SGLHLPL103†</b>	60"W x 30"D	\$1,543.00
<b>SGLHLPL102†</b>	66"W x 30"D	\$1,587.00
<b>SGLHLPL105†</b>	71"W x 30"D	\$1,728.00
<b>SGLHLPL101†</b>	71"W x 36"D	\$1,741.00

### Double Pedestal Desk Packages

- 3/4 Pedestal, (2) PL107



<b>DBLHDPL103†</b>	60"W x 30"D	\$1,543.00
<b>DBLHDPL102†</b>	66"W x 30"D	\$1,587.00
<b>DBLHDPL105†</b>	71"W x 30"D	\$1,728.00
<b>DBLHDPL101†</b>	71"W x 36"D	\$1,741.00



### Double Pedestal "L" Desk Packages

- 24" x 47" Return, (1) PL145

- 3/4 Pedestal, (2) PL107

<b>DBLHLPL103†</b>	60"W x 30"D	\$2,044.00
<b>DBLHLPL102†</b>	66"W x 30"D	\$2,088.00
<b>DBLHLPL105†</b>	71"W x 30"D	\$2,229.00
<b>DBLHLPL101†</b>	71"W x 36"D	\$2,242.00

### Double Pedestal Desk Packages

- Full Pedestal, (1) PL166, (1) PL175



<b>DBLFDPL103†</b>	60"W x 30"D	\$1,951.00
<b>DBLFDPL102†</b>	66"W x 30"D	\$1,995.00
<b>DBLFDPL105†</b>	71"W x 30"D	\$2,136.00
<b>DBLFDPL101†</b>	71"W x 36"D	\$2,149.00



### Double Pedestal "L" Desk Packages

- 24" x 47" Return, (1) PL145

- Full Pedestal, (2) PL166, (1) PL175

<b>DBLFLPL103†</b>	60"W x 30"D	\$2,452.00
<b>DBLFLPL102†</b>	66"W x 30"D	\$2,496.00
<b>DBLFLPL105†</b>	71"W x 30"D	\$2,637.00
<b>DBLFLPL101†</b>	71"W x 36"D	\$2,650.00

Note: OS Laminate finishes come standard with standard pulls. Additional optional pulls are available separately - See Page 35.

## "L" & "U" CONFIGURATIONS W/HUTCH



*Pictured w/Optional  
PL118 Tack Board*

### Desk w/Corner Extension, Return & Open Hutch

**OS208†**

Includes: PL182R†/PL166†/PL179†/PL144OH†

71"W x 66"D x 65½"H

List: \$2,765.00



*Pictured w/Optional  
PL118 Tack Board*

### Desk w/Corner Extension, Return & Hutch w/Laminate Doors

**OS209†**

Includes: PL182R†/PL166†/PL179†/PL144OH†/PL44LD†

71"W x 66"D x 65½"H

List: \$2,848.00



*Pictured w/Optional  
PL118 Tack Board*

### Desk w/Corner Extension, Return & Hutch w/Glass Doors

**OS210†**

Includes: PL182R†/PL166†/PL179†/PL144OH†/PL44SGD

71"W x 66"D x 65½"H

List: \$3,138.00



OS211†



*Pictured w/Optional  
PL118 Tack Board*

OS212†

### Bow Front Desk, Bridge, Credenza w/Corner Extension & Open Hutch

**OS211†**

Includes: PL189†/PL182R†/PL166†/PL193†/PL144OH†

71"W x 107½"D x 65½"H

List: \$3,696.00

### Bow Front Desk, Bridge, Credenza w/Corner Extension & Hutch w/Glass Doors

**OS212†**

Includes: PL189†/PL182R†/PL166†/PL193†/PL144OH†/PL44SGD

71"W x 107½"D x 65½"H

List: \$4,069.00



**NEW! AE American Elm**  
(†Select SKUs)



**CG Coastal Gray**



**ES Espresso**



**MW Modern Walnut**



**MH Mahogany**



**CH Cherry**



**WH White**



**MA Maple**

Note: American Elm **only** available for select SKUs. Select SKUs are noted by a † mark at the end of their SKU.



**OS LAMINATE**  
Coastal Gray Finish

**Multi-Person Typical  
OS148†**  
Total List: \$9,952.00  
142"W x 144"D x 40½"H  
Excludes Seating & Accessories  
Pictured w/Oslo Seating



**OS22V | Components**

SKU #	QTY	DESCRIPTION	W x D x H
PL489†	1	Bow Top w/Modesty	71 x 36/41 x 29½
PL71SGM	1	Glass Modesty Panel	40 x 1¼ x 28
PL46836†	2	False Pedestal	15¼ x 35½ x 28½
PL170†	1	Bridge	47 x 24 x 29½
PL143†	1	Credenza Shell	71 x 24 x 29½
PL166†	2	Deluxe Full Pedestal - B/B/F	15½ x 22 x 28½
PL144OH†	1	Open Hutch	71 x 15 x 36
PL44SGD	1	Silver Frame Glass Doors	17 x ¾ x 15¾
PL118	1	Tack Board (Visconti Fabric)	68¾ x ½ x 16½
PL112†	1	Two Drawer Lateral File	35½ x 22 x 29½
PL153†	1	Open Hutch	35½ x 14 x 36

**U Shape Typical  
OS22V†**  
Total List: \$8,264.00  
112"W x 106½"D x 65½"H  
Excludes Accessories  
Stocked in AE, CG & ES Only

OS22V available in **NEW! AE American Elm**,  
ES Espresso & CG Coastal Gray Only.

**OS148 | Components**

SKU #	QTY	DESCRIPTION	W x D x H
PL169NTT†	4	Reception Desk Shell	71 x 30 x 40½
PL180†	4	Reception Reversible Return	42 x 24 x 40½
PL107†	8	Hanging 3/4 Pedestal - B/F	15½ x 22 x 19

**Standard Pull Options**

Customize Your Pull Options - See Page 35

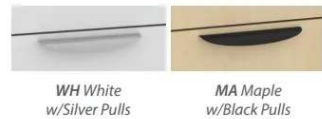

Note: American Elm **only** available for select SKUs. Select SKUs are notated by a † mark at the end of their SKU.





**OS LAMINATE**  
Coastal Gray Finish

**U Shape Typical**  
**OS19V†**  
Total List: \$9,851.00  
142"W x 107"D x 65½"H  
Excludes Seating & Accessories  
Pictured w/Veneto Seating



**NEW! OSTYP318** | Components

SKU #	QTY	DESCRIPTION	W x D x H
PL134	1	Corner Desk Shell	42 x 42 x 29½
PL179†	2	Reversible Return	30 x 24 x 29½
PL107†	2	Hanging 3/4 Pedestal - B/F	15½ x 22 x 19

OSTYP318 available in CH Cherry, MH Mahogany, ES Espresso, MW Modern Walnut & CG Coastal Gray Only.

OSTYP318 is **not available** in AE American Elm.

**NEW! L Shape Typical**  
**OSTYP318**

Total List: \$2,496.00  
72"W x 72"D x 29½"H  
Excludes Accessories

**OS19V** | Components

SKU #	QTY	DESCRIPTION	W x D x H
PL189†	1	Bow Front Desk Shell	71 x 36/41 x 29½
PL197†	1	Bridge	42 x 24 x 29½
PL143†	1	Credenza Shell	71 x 24 x 29½
PL166†	2	Deluxe Full Pedestal - B/B/F	15½ x 22 x 28½
PL152†	2	Storage Cabinet	35½ x 22 x 37¼
PL112†	2	2 Drawer Lateral File	35½ x 22 x 29½
PL144OHT	1	Open Hutch	71 x 15 x 36
PL445GD	2	Silver Frame Glass Doors (Set of 2)	17 x ¾ x 15¾
PL118	1	Tack Board (Visconti Fabric)	68¾ x ½ x 16½

**Additional Pull Options**

Customize Your Pull Options - See Page 35



Rectangular Pull  
Silver Only

Modern Bar Pull  
Silver

Modern Bar Pull  
Black



Modern Metro Pull  
Silver

Modern Metro Pull  
Black

Modern Metro Pull  
Gray



Mid-Century Pull  
Silver

Mid-Century Pull  
Black

Mid-Century Pull  
Gray

Note: American Elm **only** available for select SKUs. Select SKUs are notated by a † mark at the end of their SKU.



**OS LAMINATE**  
Coastal Gray Finish

**L Shape Typical**  
**OS266**  
Total List: \$2,328.00  
71"W x 72"D x 29½"H  
Excludes Seating & Accessories  
Pictured w/CoolMesh & Chelsea Seating  
& Optional Tempered Glass Chair Mat



**NEW! OSTYP308** | Components

SKU #	QTY	DESCRIPTION	W x D x H
PL178L†	1	Desk w/Corner Extension - Lt	71 x 23¼/42 x 29½
PL179†	1	Reversible Return	30 x 24 x 29½
PL166†	1	Deluxe Full Pedestal - B/B/F	15½ x 22 x 28½
PL208OH†	1	Wall Mount - Open Hutch	36½ x 15 x 17
PL445GD	1	Silver Frame Glass Doors (Set of 2)	17 x ¾ x 15¾

**NEW! L Shape Typical**  
**OSTYP308†**  
Total List: \$3,164.00  
71"W x 72"D x 65½"H  
Excludes Seating & Accessories  
Pictured w/Cade Seating

**OS266** | Components

SKU #	QTY	DESCRIPTION	W x D x H
PLT147T/PLTEP36/PL142	1	Bullet Top Unit*	72 x 36 x 29½
PL192†	1	Reversible Return	35 x 24 x 29½
PL166†	1	Deluxe Full Pedestal - B/B/F	15½ x 22 x 28½
OS720	1	Silver Post Leg	3"Dia x 28½

\*Bullet Top Unit - All (3) SKUs must be ordered together (top + end panel + half gable/leg).

OS266 available in ES Espresso, MA Maple, MW Modern Walnut & CG Coastal Gray Only.

**Standard Pull Options**

Customize Your Pull Options - See Page 35



**NEW! AE American Elm** w/Silver Pulls  
(†Select SKUs)

**CG Coastal Gray** w/Silver Pulls

**ES Espresso** w/Silver Pulls

**MW Modern Walnut** w/Silver Pulls

**MH Mahogany** w/Black Pulls

**CH Cherry** w/Black Pulls



**WH White** w/Silver Pulls

**MA Maple** w/Black Pulls

Note: American Elm **only** available for select SKUs. Select SKUs are notated by a † mark at the end of their SKU.





**OS LAMINATE**  
Espresso Finish

**L Shape Typical**  
**OS112**  
Total List: \$4,102.00  
71"W x 95"D x 29½"H  
Excludes Seating & Accessories  
Pictured w/CoolMesh Seating



**NEW! OSTYP322 | Components**

SKU #	QTY	DESCRIPTION	W x D x H
PL189†	1	Bow Front Desk Shell	71 x 36/41 x 29½
PL193†	1	Bridge	35 x 24 x 29½
PL143†	1	Credenza Shell	71 x 24 x 29½
PL112†	1	2 Drawer Lateral File	35½ x 22 x 29½
PL144OHT	1	Open Hutch	71 x 15 x 36
PL445GD	2	Silver Frame Glass Doors (Set of 2)	17 x ¾ x 15¾
PL118	1	Tack Board (Gray Fabric)	68½ x ½ x 16½

OSTYP322 available in **NEW! AE American Elm, CH Cherry, ES Espresso, MH Mahogany, MW Modern Walnut, CG Coastal Gray & WH White Only.**

**NEW! U Shape Typical**  
**OSTYP322†**

Total List: \$5,087.00  
71"W x 107"D x 65½"H  
Excludes Seating & Accessories  
Pictured w/Cade Seating

**OS112 | Components**

SKU #	QTY	DESCRIPTION	W x D x H
PL177R	1	Desk w/Corner Extension - Rt	71 x 30/36/42/48 x 29½
PL145†	1	Reversible Return - Rt	47 x 24 x 29½
PL166†	1	Deluxe Full Pedestal - B/B/F	15½ x 22 x 28½
PL114†	1	Combo Lateral File - B/B/F/Lat.	31 x 22 x 29½
OSPULLRSI	7	Rectangular Pulls	7 x 1 x 1

Note: Typical sold with optional pulls - See Page 35 for standard pulls.

OS112 available in **CH Cherry, ES Espresso, MH Mahogany, MW Modern Walnut, CG Coastal Gray & WH White Only.**

**Additional Pull Options**

Customize Your Pull Options - See Page 35



Rectangular Pull  
Silver Only

Modern Bar Pull  
Silver

Modern Bar Pull  
Black



Modern Metro Pull  
Silver

Modern Metro Pull  
Black

Modern Metro Pull  
Gray



Mid-Century Pull  
Silver

Mid-Century Pull  
Black

Mid-Century Pull  
Gray

Note: American Elm **only** available for select SKUs. Select SKUs are notated by a † mark at the end of their SKU.

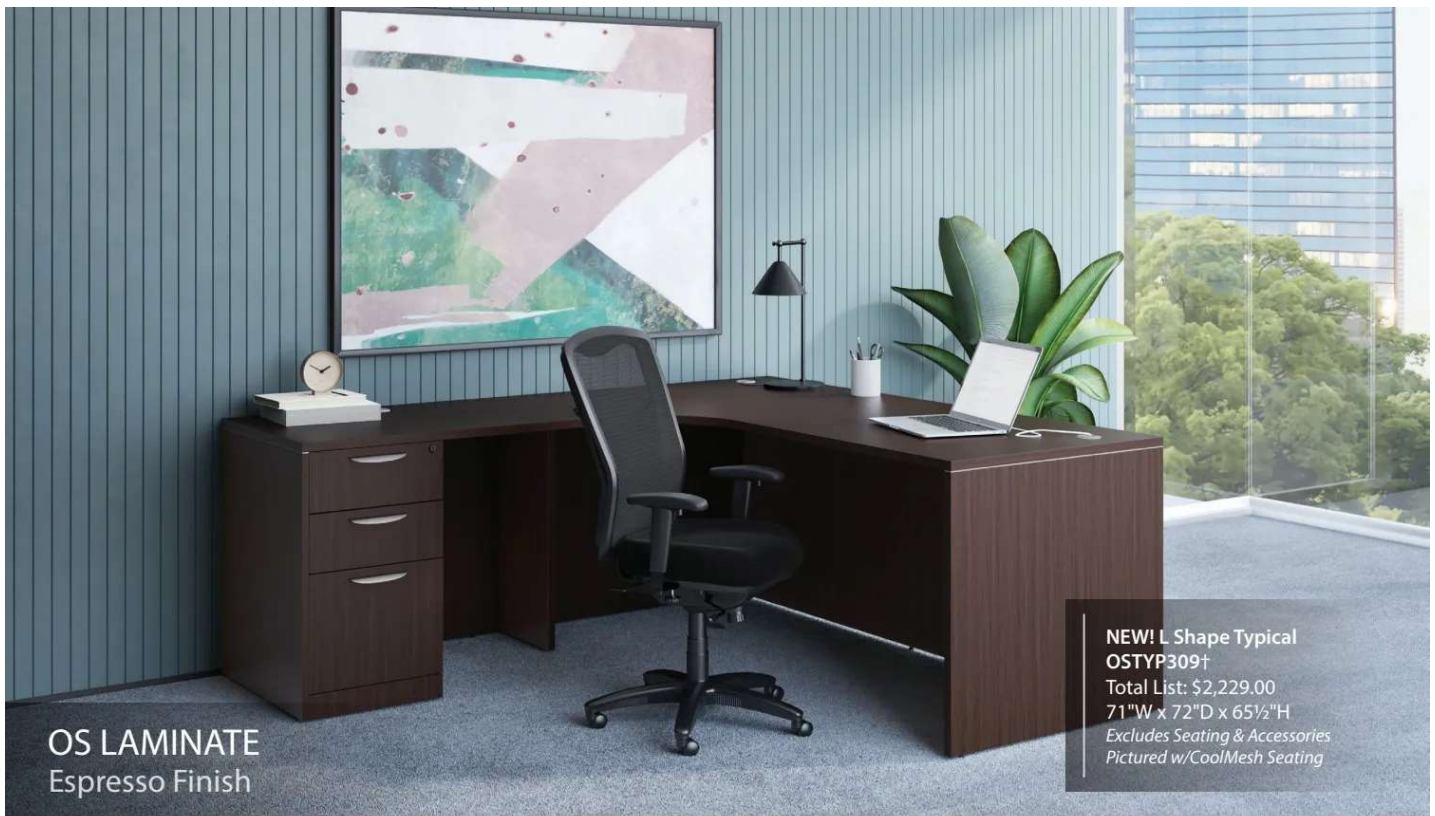

**OS LAMINATE**  
Espresso Finish

**NEW! L Shape Typical**  
**OSTYP309†**  
Total List: \$2,229.00  
71"W x 72"D x 65½"H  
Excludes Seating & Accessories  
Pictured w/CoolMesh Seating



**NEW! OSTYP328 | Components**

SKU #	QTY	DESCRIPTION	W x D x H
PL489†	1	Bow Top w/Modesty	71 x 36/41 x 29½
PL46836†	2	False Pedestal	15¼ x 35½ x 28½
PL715GM	1	Glass Modesty Panel	40 x 1¼ x 28
PL170†	1	Bridge	47 x 24 x 29½
PL143†	1	Crendza Shell	71 x 24 x 29½
PL166†	1	Deluxe Full Pedestal - B/B/F	15½ x 22 x 28½
PL144OH†	1	Open Hutch	71 x 15 x 36
PL112†	1	Two Drawer Lateral File	35½ x 22 x 29½
PL44SGD	1	Silver Frame Glass Doors	17 x ¾ x 15¼
PL152†	1	Storage Cabinet	35½ x 22 x 37¼
PL152SGD	1	Silver Frame Glass Cabinet Doors	17½ x ½ x 36¼
GBM1769	1	Magnetic Glass White Board	68½ x ½ x 16½

**NEW! U Shape Typical**  
**OSTYP328†**

Total List: \$8,833.00  
112"W x 107"D x 65½"H  
Excludes Accessories  
Pictured w/CoolMesh Seating  
Stocked in AE, CG & ES Only

OSTYP328 available in NEW! AE American Elm, ES Espresso & CG Coastal Gray Only.

**NEW! OSTYP309 | Components**

SKU #	QTY	DESCRIPTION	W x D x H
PL178L†	1	Desk w/Corner Extension - Lt	71 x 23¼/42 x 29½
PL179†	1	Reversible Return	30 x 24 x 29½
PL166†	1	Deluxe Full Pedestal - B/B/F	15½ x 22 x 28½

**Standard Pull Options**

Customize Your Pull Options - See Page 35



**NEW! AE American Elm** w/Silver Pulls  
(†Select SKUs)

**CG Coastal Gray** w/Silver Pulls

**ES Espresso** w/Silver Pulls



**MW Modern Walnut** w/Silver Pulls

**MH Mahogany** w/Black Pulls

**CH Cherry** w/Black Pulls



**WH White** w/Silver Pulls

**MA Maple** w/Black Pulls

Note: American Elm **only** available for select SKUs. Select SKUs are notated by a † mark at the end of their SKU.





**OS LAMINATE**  
Espresso Finish

**NEW! U Shape Typical  
OSTYP316**  
Total List: \$4,844.00  
72"W x 108"D x 65½"H  
Excludes Seating & Accessories  
Pictured w/CoolMesh Pro Seating



**OS24 | Components**

SKU #	QTY	DESCRIPTION	W x D x H
PL181R†	1	Credenza w/Corner Ext - Rt	66 x 24/36 x 29½
PL179†	1	Reversible Return	30 x 24 x 29½
PL166†	1	Deluxe Full Pedestal - B/B/F	15½ x 22 x 28½
PL140OH†	1	Open Hutch	66 x 15 x 36
PL40SGD	1	Silver Frame Glass Doors	18 x ½ x 15¾
PL117	1	Tack Board (Visconti Fabric)	64 x ½ x 16½
PL207†	1	Wardrobe Unit	24¼ x 23¾ x 65½

**L Shape Typical  
OS24†**  
Total List: \$5,940.00  
90¼"W x 66"D x 65½"H  
Excludes Accessories

Note: American Elm only available for select SKUs.  
Select SKUs are notated by a † mark at the end of their SKU.

**NEW! OSTYP316 | Components**

SKU #	QTY	DESCRIPTION	W x D x H
PL143†	1	Credenza Shell	71 x 24 x 29½
PLTULEG30	2	Unite Leg	29½ x 1½ x 28½
PLTCBBSINGLE	2	Connector Beam Bracket	
PLTADJMDB4872	1	Top Support Beam	67½ x 2 x 1
PLT2436†	1	Return Top	36 x 24 x 1
PLT3072†	1	Rectangular Top	72 x 30 x 1
PL166†	1	Deluxe Full Pedestal - B/B/F	15½ x 22 x 28½
PL144OH†	1	Open Hutch	71 x 15 x 36
PL44LD†	1	Laminate Hutch Doors (Set of 2)	17 x ¾ x 15¾
GBM1769	1	Magnetic Glass White Board	68½ x ½ x 16½
PLTFB	4	Flat Brackets	
PLTLMP66	1	Laminate Modesty Panel	66 x ¾ x 18

OSTYP316 is not available in AE American Elm.

**Additional Pull Options**  
Customize Your Pull Options - See Page 35



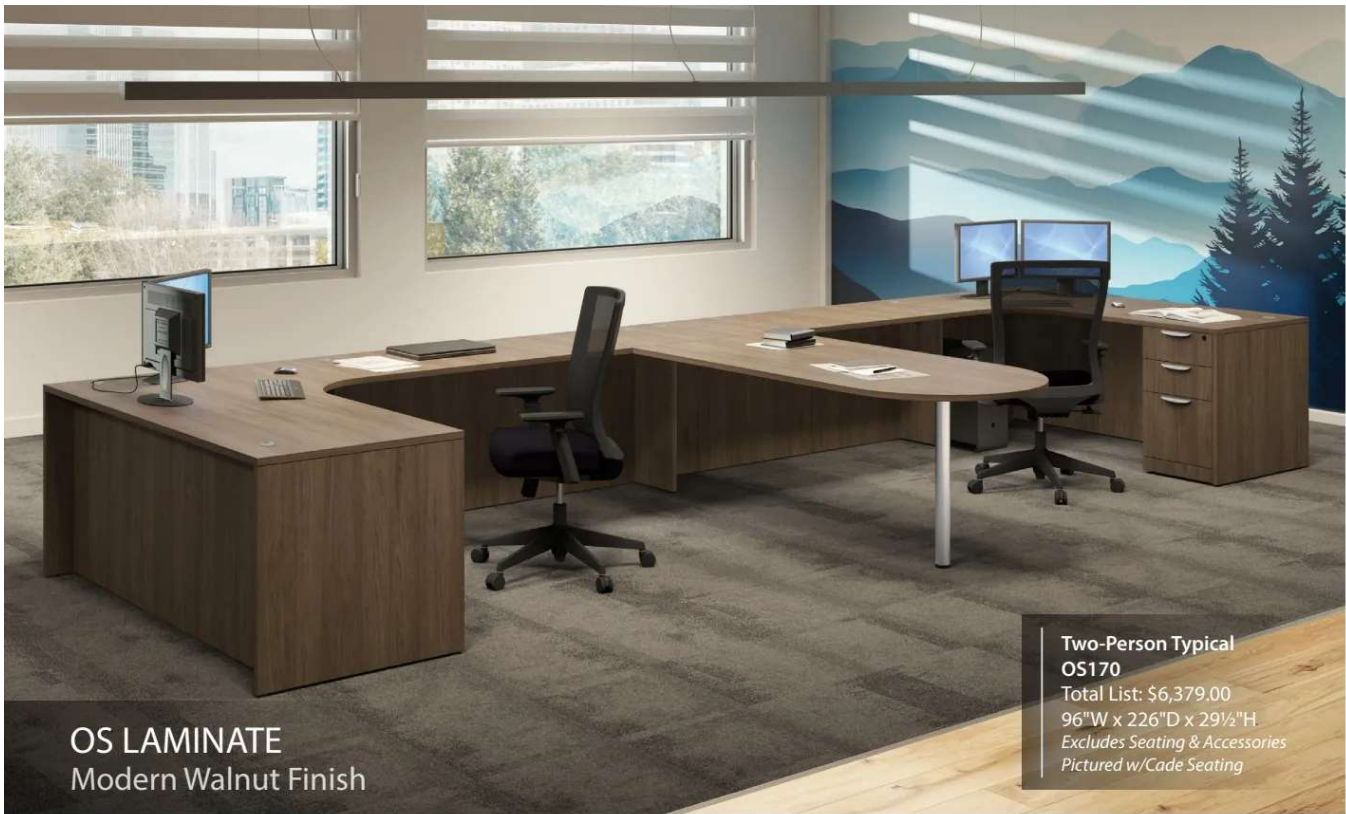

**OS LAMINATE**  
Modern Walnut Finish

**Two-Person Typical  
OS170**  
Total List: \$6,379.00  
96"W x 226"D x 29½"H  
Excludes Seating & Accessories  
Pictured w/Cade Seating



**OS170 | Components**

SKU #	QTY	DESCRIPTION	W x D x H
PL178Lt	1	Desk w/Corner Extension - Lt	71 x 23¼/42 x 29½
PL178Rt	1	Desk w/Corner Extension - Rt	71 x 23¼/42 x 29½
PL143†	2	Credenza Shell	71 x 24 x 29½
PL142†	4	Half Legs	12¾ x 1 x 28
PL166†	2	Deluxe Full Pedestal - B/B/F	15½ x 22 x 28½
PLT147T	1	Bullet Top	72 x 36 x 1
OS720	1	Silver Post Leg	3" Dia x 28½
PLT72MSBK	1	Stiffener Support (Set of 2)	60¼ x 2¼ x 1
PLTFB	3	Flat Brackets	

OS170 available in *CG Coastal Gray, ES Espresso, MA Maple & MW Modern Walnut* Only.

**Standard Pull Options**  
Customize Your Pull Options - See Page 35



**NEW! AE American Elm** w/Silver Pulls  
(†Select SKUs)

**CG Coastal Gray** w/Silver Pulls

**ES Espresso** w/Silver Pulls



**MW Modern Walnut** w/Silver Pulls

**MH Mahogany** w/Black Pulls

**CH Cherry** w/Black Pulls



**WH White** w/Silver Pulls

**MA Maple** w/Black Pulls

**NEW! OSTYP317 | Components**

SKU #	QTY	DESCRIPTION	W x D x H
PLT4172†	4	Standing Table	72 x 30 x 41¾

OSTYP317 available in *NEW! AE American Elm, ES Espresso, MW Modern Walnut, CG Coastal Gray & WH White* Only.

**NEW! Multi-Person Typical  
OSTYP317†**

Total List: \$5,064.00  
144"W x 60"D x 41"H  
Excludes Accessories

Note: American Elm only available for select SKUs. Select SKUs are notated by a † mark at the end of their SKU.





**OS LAMINATE**  
Modern Walnut Finish

**NEW! Four-Person Typical  
(2) OS170**  
Total List: \$12,758.00  
96"W x 226"D x 29½"H  
\*Based on (2) OS170 put together  
Excludes Seating & Accessories  
Pictured w/Cade Seating



**OS154 | Components**

SKU #	QTY	DESCRIPTION	W x D x H
PL143†	1	Credenza Shell	71 x 24 x 29½
PL114†	1	Combo Lateral File - B/B/F/Lat.	31 x 22 x 29½
PL207†	1	Wardrobe Storage Unit	24¼ x 23¾ x 65½
PL144OHT	1	Open Hutch	71 x 15 x 36
PL445GD	1	Silver Frame Glass Doors	17 x ¾ x 15¾
GBM1769	1	Magnetic Glass White Board	68½ x ½ x 16½

Note: American Elm only available for select SKUs.  
Select SKUs are notated by a † mark at the end of their SKU.

**Simple Desk Typical  
OS154†**  
Total List: \$6,178.00  
95¼"W x 24"D x 65½"H  
Excludes Accessories

**NEW! (2) OS170 | Components**

SKU #	QTY	DESCRIPTION	W x D x H
PL178L†	2	Desk w/Corner Extension - Lt	71 x 23¼/42 x 29½
PL178R†	2	Desk w/Corner Extension - Rt	71 x 23¼/42 x 29½
PL143†	4	Credenza Shell	71 x 24 x 29½
PL142†	8	Half Legs	12¾ x 1 x 28
PL166†	4	Deluxe Full Pedestal - B/B/F	15½ x 22 x 28½
PLT147†	2	Bullet Top	72 x 36 x 1
OS720	2	Silver Post Leg	3"Dia x 28½
PLT72MSBK	2	Stiffener Support (Set of 2)	60¼ x 2¼ x 1
PLTFB	6	Flat Brackets	

(2) OS170 available in CG Coastal Gray, ES Espresso, MA Maple & MW Modern Walnut Only.

Note: This typical is based on (2) OS170 put together to form a four-person workstation.

**Additional Pull Options**

Customize Your Pull Options - See Page 35





**OS LAMINATE**  
Modern Walnut Finish

**U Shape Typical**  
**OS239**

Total List: \$4,386.00  
72"W x 102"D x 65½"H  
Excludes Seating, Bookcases  
& Accessories  
Pictured w/Tre & Big & Tall Seating &  
Optional Tempered Glass Chair Mat



**OS31 | Components**

SKU #	QTY	DESCRIPTION	W x D x H
PL182R†	1	Credenza w/Corner Ext. - Rt	71 x 24/36 x 29½
PL192†	1	Reversible Return	35 x 24 x 29½
PL166†	1	Deluxe Full Pedestal - B/B/F	15½ x 22 x 28½
PL208OH†	1	Wall Mount - Open Hutch	36½ x 15 x 17
PL44LD†	1	Laminate Door (Sets of 2)	17 x ¾ x 15¾

\*Height does not include wall mounted hutches.

Note: American Elm **only** available for select SKUs.  
Select SKUs are notated by a † mark at the end of their SKU.

**L Shape Typical**  
**OS31†**

Total List: \$2,577.00  
71"W x 71"D x 29½"H  
Excludes Seating & Accessories  
Pictured w/CoolMesh Seating

**OS239 | Components**

SKU #	QTY	DESCRIPTION	W x D x H
PLT147/PLTEP36/PL142	1	Bullet Top Unit*	72 x 36 x 29½
OS720	1	Post Leg	3"Dia x 28½"
PL197†	1	Bridge	42 x 24 x 29½
PL143†	1	Credenza Shell	71 x 24 x 29½
PL107†	1	Hanging 3/4 Pedestal - B/F	15½ x 22 x 19
PL144OH†	1	Open Hutch	71 x 15 x 36
PL44SGD	1	Silver Frame Glass Doors	17 x ¾ x 15¾
GBM1769	1	Magnetic Glass White Board	68½ x ½ x 16½

\*Bullet Top Unit - All (3) SKUs must be ordered together (top + end panel + half gable/leg).

OS239 available in ES Espresso, MA Maple, MW Modern Walnut & CG Coastal Gray Only.

**Standard Pull Options**

Customize Your Pull Options - See Page 35



**NEW! AE American Elm** w/Silver Pulls  
(†Select SKUs)

**CG Coastal Gray** w/Silver Pulls

**ES Espresso** w/Silver Pulls



**MW Modern Walnut** w/Silver Pulls

**MH Mahogany** w/Black Pulls

**CH Cherry** w/Black Pulls



**WH White** w/Silver Pulls

**MA Maple** w/Black Pulls





**OS LAMINATE**  
Mahogany Finish

**U Shape Typical**  
**OS88†**

Total List: \$4,514.00  
71"W x 112"D x 65½"H  
Excludes Seating & Accessories  
Pictured w/Tre Seating



**OS89 | Components**

SKU #	QTY	DESCRIPTION	W x D x H
PL101†	1	Desk Shell	71 x 35½ x 29½
PL145†	1	Reversible Return (Rt)	47 x 24 x 29½
PL166†	1	Deluxe Full Pedestal - B/B/F	15½ x 22 x 28½
PL175†	1	Deluxe Full Pedestal - F/F	15½ x 22 x 28½
PL144OHT	1	Open Hutch	71 x 15 x 36
PL44SGD	1	Silver Frame Glass Doors	17 x ¾ x 15¾
PL118	1	Tack Board (Visconti Fabric)	68% x ½ x 16½

**L Shape Typical**  
**OS89†**

Total List: \$4,233.00  
71"W x 83"D x 65½"H  
Excludes Accessories

**OS88 | Components**

SKU #	QTY	DESCRIPTION	W x D x H
PL189†	1	Bow Front Desk Shell	71 x 36/41 x 29½
PL193†	1	Bridge	35 x 24 x 29½
PL182R†	1	Credenza w/Corner Ext (Rt)	71 x 24/36 x 29½
PL166†	1	Deluxe Full Pedestal - B/B/F	15½ x 22 x 28½
PL144OHT	1	Open Hutch	71 x 15 x 36
PL44SGD	1	Silver Frame Glass Doors	17 x ¾ x 15¾
GBM1769	1	Magnetic Glass White Board	68½ x ½ x 16½

**Additional Pull Options**

Customize Your Pull Options - See Page 35



Note: American Elm **only** available for select SKUs. Select SKUs are notated by a † mark at the end of their SKU.



**OS LAMINATE**  
Mahogany Finish

**NEW! U Shape Typical**  
**OSTYP329**  
Total List: \$7,610.00  
94¾"W x 107"D x 65½"H  
Excludes Seating & Accessories  
Pictured w/CoolMesh Seating &  
Optional Tempered Glass Chair Mat



**OS263 | Components**

SKU #	QTY	DESCRIPTION	W x D x H
PL187†	1	Bow Front Desk Shell	66 x 30/35½ x 29½
PL166†	1	Deluxe Full Pedestal - B/B/F	15½ x 22 x 28½
PL170†	1	Bridge	47 x 24 x 29½
PL111†	1	Credenza Shell	66 x 24 x 29½

Note: American Elm only available for select SKUs.  
Select SKUs are notated by a † mark at the end of their SKU.

**NEW! OSTYP329 | Components**

SKU #	QTY	DESCRIPTION	W x D x H
PL207†	1	Wardrobe Unit	24¼ x 23¾ x 65½
PL143†	1	Credenza Shell	71 x 24 x 29½
PL114†	1	Combo Lateral File - B/B/F/Lat.	31 x 22 x 29½
PL144OH†	1	Open Hutch	71 x 15 x 36
PL118	1	Tack Board (Gray Fabric)	68⅞ x ½ x 16½
PL193†	1	Bridge	35 x 24 x 29½
PL177L	1	Desk w/Corner Extension (Lt)	71 x 30/36/42/48 x 29½
PL44SGD	1	Silver Frame Glass Doors	17 x ¾ x 15¾

OSTYP329 available in CH Cherry, ES Espresso, MH Mahogany, MW Modern Walnut, CG Coastal Gray & WH White Only.

**Standard Pull Options**  
Customize Your Pull Options - See Page 35



**NEW! AE American**  
Elm w/Silver Pulls  
(†Select SKUs)

**CG Coastal Gray**  
w/Silver Pulls

**ES Espresso**  
w/Silver Pulls

**MW Modern Walnut**  
w/Silver Pulls

**MH Mahogany**  
w/Black Pulls

**CH Cherry**  
w/Black Pulls

**WH White**  
w/Silver Pulls

**MA Maple**  
w/Black Pulls

**U Shape Typical**  
**OS263†**

Total List: \$2,615.00  
66"W x 106½"D x 29½"H  
Excludes Seating & Accessories  
Pictured w/Charleston & Ebony Seating





**OS LAMINATE**  
Mahogany Finish

**U Shape Typical**  
**OS245†**  
Total List: \$4,221.00  
71"W x 112"D x 65½"H  
Excludes Accessories



**OS238 | Components**

SKU #	QTY	DESCRIPTION	W x D x H
PL177L	1	Desk w/Corner Extension (Lt)	71 x 30/36/42/48 x 29½
PL193†	1	Bridge	35 x 24 x 29½
PL143†	1	Credenza Shell	71 x 24 x 29½
PL166†	1	Deluxe Full Pedestal - B/B/F	15½ x 22 x 28½
PL144OH†	1	Open Hutch	71 x 15 x 36
PL44SGD	2	Silver Frame Glass Doors	17 x ¾ x 15¾
PL118	1	Tack Board (Gray Fabric)	68% <sup>10</sup> x ½ x 16½
PL161	1	Corner Bookcase	15 x 15 x 36
PL160	1	Corner Bookcase	24 x 24 x 29½

**U Shape Typical**  
**OS238**

Total List: \$5,998.00  
95"W x 107"D x 65½"H  
Excludes Accessories

OS238 available in *CH Cherry, ES Espresso, MH Mahogany, MW Modern Walnut & CG Coastal Gray Only.*

**OS245 | Components**

SKU #	QTY	DESCRIPTION	W x D x H
PL189†	1	Bow Front Desk Shell	71 x 36/41 x 29½
PL193†	1	Bridge	35 x 24 x 29½
PL182R†	1	Credenza w/Corner Ext (Rt)	71 x 24/36 x 29½
PL166†	1	Deluxe Full Pedestal - B/B/F	15½ x 22 x 28½
PL144OH†	1	Open Hutch	71 x 15 x 36
PL44LD†	2	Laminate Doors (Sets of 2)	17 x ¾ x 15¾
PL118	1	Tack Board (Gray Fabric)	68% <sup>10</sup> x ½ x 16½

**Additional Pull Options**

Customize Your Pull Options - See Page 35

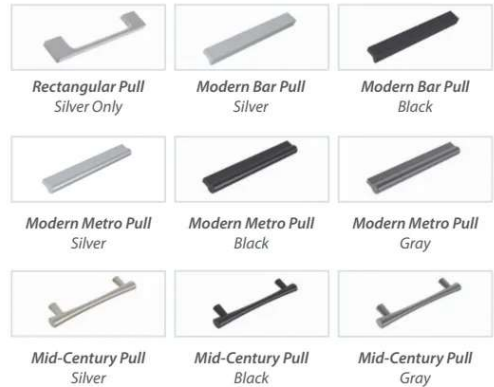

Note: American Elm only available for select SKUs. Select SKUs are notated by a † mark at the end of their SKU.



**OS LAMINATE**  
Cherry Finish

**Multi-Person Typical  
OS200†**  
Total List: \$4,248.00  
213"W x 30"D x 40½"H  
Excludes Seating & Accessories  
Pictured w/Advanced Seating



**OS246 | Components**

SKU #	QTY	DESCRIPTION	W x D x H
PL182R†	1	Credenza w/Corner Ext (Rt)	71 x 24/36 x 29½
PL192†	1	Reversible Return	35 x 24 x 29½
PL144OH†	1	Open Hutch	71 x 15 x 36
PL44SGD	1	Silver Frame Glass Doors	17 x ¾ x 15¾
PL118	1	Tack Board (Gray Fabric)	68¾ x ½ x 16½
PL166†	1	Deluxe Full Pedestal - B/B/F	15½ x 22 x 28½

**L Shape Typical  
OS246†**  
Total List: \$3,515.00  
71"W x 71"D x 65½"H  
Excludes Seating & Accessories  
Pictured w/Advanced Seating

**OS200 | Components**

SKU #	QTY	DESCRIPTION	W x D x H
PL169NTT†	3	Reception Desk Shell	71 x 30 x 40½
PL107†	3	Hanging 3/4 Pedestal - B/F	15½ x 22 x 19

**Standard Pull Options**

Customize Your Pull Options - See Page 35



**NEW! AE American Elm** w/Silver Pulls  
(†Select SKUs)

**CG Coastal Gray** w/Silver Pulls

**ES Espresso** w/Silver Pulls



**MW Modern Walnut** w/Silver Pulls

**MH Mahogany** w/Black Pulls

**CH Cherry** w/Black Pulls



**WH White** w/Silver Pulls

**MA Maple** w/Black Pulls

Note: American Elm only available for select SKUs. Select SKUs are noted by a † mark at the end of their SKU.





OS LAMINATE  
Cherry Finish

**Executive Typical  
OS74**

Total List: \$11,140.00

107"W x 65½"H

\*Depth will depend on space left for chair

Excludes Seating & Accessories

Pictured w/Bradley & Dover Seating



**OS265 | Components**

SKU #	QTY	DESCRIPTION	W x D x H
PL2044OH†	2	Wall Mount - Open Hutch	71 x 15 x 17
PL44LD†	4	Laminate Doors (Sets of 2)	17 x ¾ x 15¾
PL182L†	2	Credenza w/Corner Ext.	71 x 24/36 x 29½
PL192†	2	Reversible Return	35 x 24 x 29½
PL166†	2	Deluxe Full Pedestal - B/B/F	15½ x 22 x 28½

Note: American Elm only available for select SKUs.  
Select SKUs are notated by a † mark at the end of their SKU.

**Multi-Person Typical  
OS265†**

Total List: \$6,088.00

142"W x 71"D x 29½"H

Excludes Seating & Accessories

Pictured w/Advanced Seating

**OS74 | Components**

SKU #	QTY	DESCRIPTION	W x D x H
PL189†	1	Bow Front Desk Shell	71 x 36/41 x 29½
PL166†	2	Deluxe Full Pedestal - B/B/F	15½ x 22 x 28½
PL150	2	Personal Storage Cabinet	17¾ x 23¾ x 65½
PL150151SGD	2	Glass Storage Cabinet Doors	18 x ½ x 65½
PL113†	2	Storage Cabinet - 29½"H	35½ x 22 x 29½
PL1135GD	2	Glass Storage Cabinet Doors	17¾ x ½ x 29½
PL110†	1	Top (To Create Credenza)	71 x 22 x 1
PL2044OH†	1	Wall Mount - Open Hutch	71 x 15 x 17
PL44SGD	2	Silver Frame Glass Doors	17 x ¾ x 15¾
PL118	1	Tack Board (Gray Fabric)	68½ x ½ x 16½
OSPULLHLSI	12	Silver Crescent Pulls	7 x 1 x 1

Note: Typical sold with optional pulls - See Page 35 for standard pulls.

OS74 is not available in AE American Elm.

**Additional Pull Options**

Customize Your Pull Options - See Page 35



Rectangular Pull  
Silver Only

Modern Bar Pull  
Silver

Modern Bar Pull  
Black



Modern Metro Pull  
Silver

Modern Metro Pull  
Black

Modern Metro Pull  
Gray



Mid-Century Pull  
Silver

Mid-Century Pull  
Black

Mid-Century Pull  
Gray



**OS LAMINATE**  
Maple Finish

**L Shape Typical**  
**OS127†**  
Total List: \$4,522.00  
71"W x 83"D x 65½"H  
Excludes Seating & Accessories  
Pictured w/Advanced Seating



**OS56 | Components**

SKU #	QTY	DESCRIPTION	W x D x H
PL101†	1	Desk Shell	71 x 35½ x 29½
PL170†	1	Bridge	47 x 24 x 29½
PL143†	1	Credenza Shell	71 x 24 x 29½
PL112†	1	2 Drawer Lateral File	35½ x 22 x 29½
PL144OH†	1	Open Hutch	71 x 15 x 36
PL44LD†	2	Laminate Hutch Doors (Set of 2)	17 x ¾ x 15¾
PL118	1	Tack Board (Gray Fabric)	68¾ x ½ x 16½

**U Shape Typical**  
**OS56†**  
Total List: \$4,367.00  
71"W x 107"D x 65½"H  
Excludes Seating, Keyboard System & Accessories  
Pictured w/CoolMesh & Aero Seating

**OS127 | Components**

SKU #	QTY	DESCRIPTION	W x D x H
PL101†	1	Desk Shell	71 x 35½ x 29½
PL145†	1	Reversible Return	47 x 24 x 29½
PL166†	1	Deluxe Full Pedestal - B/B/F	15½ x 22 x 28½
PL175†	1	Deluxe Full Pedestal - F/F	15½ x 22 x 28½
PL144OH†	1	Open Hutch	71 x 15 x 36
PL44SLIDESGD	2	Sliding Glass Doors (Sets of 2)	18 x ½ x 15¾
PL44RAIL	1	Rails For Glass Doors	69 x 1 x 1
PL118	1	Tack Board (Visconti Fabric)	68¾ x ½ x 16½

**Standard Pull Options**  
Customize Your Pull Options - See Page 35

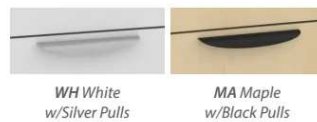

Note: American Elm **only** available for select SKUs. Select SKUs are notated by a † mark at the end of their SKU.





**OS LAMINATE**  
Maple Finish

**L Shape Typical**  
**OS244†**  
Total List: \$5,971.00  
90½"W x 66"D x 65½"H  
Excludes Seating & Accessories  
Pictured w/Cade Seating



**OS233 | Components**

SKU #	QTY	DESCRIPTION	W x D x H
PL189†	1	Bow Front Desk Shell	71 x 36/41 x 29½
PL193†	1	Bridge	35 x 24 x 29½
PL182R†	1	Credenza w/Corner Ext (Rt)	71 x 24/36 x 29½
PL144OH†	1	Open Hutch	71 x 15 x 36
PL44SGD	1	Silver Frame Glass Doors (Sets of 2)	17 x ¾ x 15¾
PL166†	1	Deluxe Full Pedestal - B/B/F	15½ x 22 x 28½
GBM1769	1	Magnetic Glass White Board	68½ x ½ x 16½

**U Shape Typical**  
**OS233†**  
Total List: \$4,514.00  
71"W x 112"D x 65½"H  
Excludes Seating & Accessories  
Pictured w/CoolMesh Pro Seating

**OS244 | Components**

SKU #	QTY	DESCRIPTION	W x D x H
PL207†	1	Wardrobe Unit	24¼ x 23¼ x 65½
PL181R†	1	Credenza w/Corner Ext. - Rt	66 x 24/36 x 29½
PL179†	1	Reversible Return	30 x 24 x 29½
PL166†	1	Deluxe Full Pedestal - B/B/F	15½ x 22 x 28½
PL140OH†	1	Open Hutch	66 x 15 x 36
PL40LD†	1	Laminate Doors	16 x ½ x 15¾
PL117	1	Tack Board (Gray Fabric)	64 x ½ x 16½
OSPULLBARBK	7	Modern Bar Pulls	7 x 1 x 1

Note: Typical sold with optional pulls - See Page 35 for standard pulls.

**Additional Pull Options**

Customize Your Pull Options - See Page 35



Note: American Elm **only** available for select SKUs. Select SKUs are notated by a † mark at the end of their SKU.



**U Shape Typical  
OS243†**  
Total List: \$7,637.00  
106½"W x 112¼"D x 65½"H  
Excludes Seating & Accessories  
Pictured w/CoolMesh Pro Seating

**OS LAMINATE  
White Finish**



**OS264 | Components**

SKU #	QTY	DESCRIPTION	W x D x H
PL189†	1	Bow Front Desk Shell	71 x 36/41 x 29½
PL170†	1	Bridge	47 x 24 x 29½
PL143†	1	Credenza Shell	71 x 24 x 29½
PL166†	2	Deluxe Full Pedestal - B/B/F	15½ x 22 x 28½
PL144OH†	1	Open Hutch	71 x 15 x 36
PL44LD†	2	Laminate Hutch Doors (Set of 2)	17 x ¾ x 15¼

**U Shape Typical  
OS264†**

Total List: \$4,359.00  
71"W X 112"D X 65½"H  
Excludes Seating & Accessories  
Pictured w/CoolMesh & Advanced Seating

Note: American Elm only available for select SKUs.  
Select SKUs are notated by a † mark at the end of their SKU.

**OS243 | Components**

SKU #	QTY	DESCRIPTION	W x D x H
PL189†	1	Bow Front Desk Shell	71 x 36/41 x 29½
PL170†	1	Bridge	47 x 24 x 29½
PL143†	1	Credenza Shell	71 x 24 x 29½
PL166†	1	Deluxe Full Pedestal - B/B/F	15½ x 22 x 28½
PL144OH†	1	Open Hutch	71 x 15 x 36
PL44SGD	2	Silver Frame Glass Doors (Sets of 2)	17 x ¾ x 15¼
PL118	1	Tack Board (Gray Fabric)	68½ x ½ x 16½
PL112†	1	2 Drawer Lateral File	35½ x 22 x 29½
PL152†	1	Storage Cabinet	35½ x 22 x 37¼
PL152SGD	1	Silver Frame Glass Cabinet Doors	17½ x ½ x 36¼

**Standard Pull Options**

Customize Your Pull Options - See Page 35

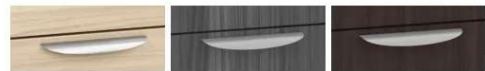

**NEW! AE American Elm** w/Silver Pulls  
(†Select SKUs)

**CG Coastal Gray** w/Silver Pulls

**ES Espresso** w/Silver Pulls



**MW Modern Walnut** w/Silver Pulls

**MH Mahogany** w/Black Pulls

**CH Cherry** w/Black Pulls



**WH White** w/Silver Pulls

**MA Maple** w/Black Pulls





OS LAMINATE  
White Finish

**NEW! Modern Typical  
OSTYP323†**  
Total List: \$9,316.00  
142"W x 72"D x 65½"H  
Excludes Accessories



**OS96 | Components**

SKU #	QTY	DESCRIPTION	W x D x H
PL181R†	1	Credenza w/Corner Ext - Rt	66 x 24/36 x 29½
PL179†	1	Reversible Return	30 x 24 x 29½
PL107†	1	Hanging 3/4 Pedestal - B/F	15½ x 22 x 19
PL140OH†	1	Open Hutch	66 x 15 x 36
PL40LD†	2	Laminate Doors (Sets of 2)	16 x ½ x 15¾
PL117	1	Tack Board (Gray Fabric)	64 x ½ x 16½

**L Shape Typical  
OS96†**

Total List: \$3,029.00  
66"W x 66"D x 65½"H  
Excludes Accessories

Note: American Elm only available for select SKUs.  
Select SKUs are notated by a † mark at the end of their SKU.

**NEW! OSTYP323 | Components**

SKU #	QTY	DESCRIPTION	W x D x H
PL1012†	2	2 Drawer Persona Cabinet	35½ x 22 x 22
PL2013†	2	Open Shelf Cabinet	35½ x 22 x 22
PL110†	1	File/Storage Top	71 x 22 x 1
CUSH2136	1	Top Cushion	35½ x 22 x 1½
PL109†	1	File/Storage Top	35½ x 22 x 1
PLTLEGBV30	1	Beveled Leg Base	30 x 3 x 28¾
PLTADJMDB4872	1	Adjustable Beam	67¾ x 2 x 1
PLTDR2430	1	Desk Riser	23¾ x 2 x 6½
PLT3072†	1	Rectangular Top	72 x 30 x 1
PL152†	1	Storage Cabinet	35½ x 22 x 37¾
PL208OH†	2	Open Hutch	36½ x 15 x 17
PLTCBBEV	1	Connector Beam Bracket	
OSPULLHLBK	6	Black Crescent Pulls	7 x 1 x 1

Note: Typical Sold With Optional Pulls - See Page 35 for Standard Pulls.

**Additional Pull Options**

Customize Your Pull Options - See Page 35





**OS LAMINATE**  
Combination Finish

**U Shape Typical  
OS21+**  
Total List: \$7,350.00  
106½"W x 112"D x 65½"H  
Excludes Seating & Accessories  
Pictured w/Bradley & Tre Seating



**OS235 | Components**

SKU #	QTY	DESCRIPTION	W x D x H
PL101†	1	Desk Shell	71 x 35½ x 29½
PL166†	1	Deluxe Full Pedestal - B/B/F	15½ x 22 x 28½
PL175†	1	Deluxe Full Pedestal - F/F	15½ x 22 x 28½
OSPULLRSI	5	Rectangular Pulls	7 x 1 x 1

Note: Typical Sold With Optional Pulls - See Page 35 for Standard Pulls.

Note: American Elm **only** available for select SKUs.  
Select SKUs are notated by a † mark at the end of their SKU.

**Simple Desk Typical  
OS235†**

Total List: \$2,379.00  
71"W x 35½"D x 29½"H  
Excludes Seating & Accessories  
Pictured w/Cade Seating

**OS21 | Components**

SKU #	QTY	DESCRIPTION	W x D x H
PL189†	1	Bow Front Desk Shell	71 x 36/41 x 29½
PL170†	1	Bridge	47 x 24 x 29½
PL143†	1	Credenza Shell	71 x 24 x 29½
PL166†	1	Deluxe Full Pedestal - B/B/F	15½ x 22 x 28½
PL144OH†	1	Open Hutch	71 x 15 x 36
PL445GD	1	Silver Frame Glass Doors (Sets of 2)	17 x ¾ x 15¾
PL112†	1	Two Drawer Lateral File	35½ x 22 x 29½
PL152†	1	Storage Cabinet	35½ x 22 x 37¼
PL152SGD	1	Silver Frame Glass Cabinet Doors	17½ x ½ x 36¼
GBM1769	1	Magnetic Glass White Board	68½ x ½ x 16½

**Standard Pull Options**

Customize Your Pull Options - See Page 35



**NEW! AE American Elm** w/Silver Pulls  
(†Select SKUs)

**CG Coastal Gray** w/Silver Pulls

**ES Espresso** w/Silver Pulls



**MW Modern Walnut** w/Silver Pulls

**MH Mahogany** w/Black Pulls

**CH Cherry** w/Black Pulls



**WH White** w/Silver Pulls

**MA Maple** w/Black Pulls

Note: Must specify color(s) when ordering combination typicals.





**OS LAMINATE**  
Combination Finish

**U Shape Typical**  
**OS234†**  
Total List: \$4,907.00  
72"W x 108"D x 65½"H  
Excludes Seating & Accessories  
Pictured w/CoolMesh Pro Seating



**OS97 | Components**

SKU #	QTY	DESCRIPTION	W x D x H
PL169NTT†	1	Reception Desk Shell	71 x 30 x 40½
PL169TT†	1	Transaction Top	71 x 17¾ x 1
PL169RISER	1	Metal Counter Riser	¾ Dia x 1
PL180†	1	Reception Return Shell	42 x 24 x 40½
PL107†	2	Hanging 3/4 Pedestal - B/F	15½ x 22 x 19

**Reception Typical**  
**OS97†**

Total List: \$2,805.00  
71"W x 78"D x 42½"H  
Excludes Seating & Accessories  
Pictured w/CoolMesh Seating

Note: American Elm **only** available for select SKUs.  
Select SKUs are notated by a † mark at the end of their SKU.

**OS234 | Components**

SKU #	QTY	DESCRIPTION	W x D x H
PL105†	1	Desk Shell	71 x 30 x 29½
PL166†	1	Deluxe Full Pedestal - B/B/F	15½ x 22 x 28½
PL144OH†	1	Open Hutch	71 x 15 x 36
PL44LD†	1	Laminate Hutch Doors	17 x ¾ x 15¾
GBM1769	1	Magnetic Glass White Board	68½ x ½ x 16½
PLT2448†	1	Return Top	48 x 24 x 1
PLT3072†	1	Rectangular Top	72 x 30 x 1
PLTULEG30	2	Unite Leg	29½ x 1¾ x 28½
PLTADJMDB4872	1	Top Support Beam	67¾ x 2 x 1
PLTFB	4	Flat Brackets	
PLTCBSINGLE	2	Connector Beam Bracket	
PLT72MSBK	1	Stiffener Support (Set of 2)	60¼ x 2¼ x 1

**Additional Pull Options**

Customize Your Pull Options - See Page 35



**Rectangular Pull**  
Silver Only

**Modern Bar Pull**  
Silver

**Modern Bar Pull**  
Black



**Modern Metro Pull**  
Silver

**Modern Metro Pull**  
Black

**Modern Metro Pull**  
Gray



**Mid-Century Pull**  
Silver

**Mid-Century Pull**  
Black

**Mid-Century Pull**  
Gray

Note: Must specify color(s) when ordering combination typicals.

# VARIANT

Base Styles (3 Base Options)

Work Surfaces (2 Shapes, Several Sizes, 8 Finish Options)



Note: Tops, Legs & Supports are sold separately to create more flexible workstation options.



# VARIANT

Variant by OfficeSource® boasts sleek, stylish components that promote diversity, simplicity and functional modularity. All leg options come standard with adjustable glides.

Coordinates well with our OS Laminate by OfficeSource® storage units, mounted hutches, privacy panels, upholstered seat cushions, surface mount power modules and cable management trays.

These features create working environments that are alive and inspirational in many kinds of offices. From classic offices to open concept layouts, the endless possibilities of the Variant will surely enhance creativity and productivity in the workplace.

## Choose Your Configuration Style (Unite & Oblique Leg Styles Pictured Below)



28 1/2" Height ▲  
41" Height ▶

### Configuration Diagram #1

Single Desk (28 1/2"H - Silver or Black)  
Single Desk (41"H - Unite Leg Only)  
*Note: 41"H Leg (Silver Only)*



▲ 24"D Return Tops  
w/Riser + Storage

### Configuration Diagram #2

L Shape Desk  
Available in 28 1/2"H



w/Ext. Support ▲  
w/Oblique Leg ▶

### Configuration Diagram #3

L Shape Desk  
Available in 28 1/2"H



w/U Support Brackets ▲

### Configuration Diagram #4

U Shape Desk  
Available in 28 1/2"H



w/Multi-Person Workstations ▲

### Configuration Diagram #5

Multi-Person Workstations  
Available in 28 1/2"H



Back-to-Back Workstations ▲

### Configuration Diagram #6

Back-to-Back Desks (Oblique Leg)  
Available in 28 1/2"H  
*Note: Gap can be left in center for wire management.*

#### Laminate Top Finishes



NEWI AE American Elm (†Select SKUs) CG Coastal Gray ES Espresso MW Modern Walnut MH Mahogany CH Cherry WH White MA Maple

*Note: American Elm **only** available for select SKUs. Select SKUs are notated by a † mark at the end of their SKU.*

#### Metal Leg Base Finishes



BK Black SI Silver

#### Wood Leg Base Finishes



CG Coastal Gray MW Modern Walnut

# VARIANT

## UNITE STYLE BASES

Unite Legs available in two heights: 28½" & 41"H. Also, available with an adjustable height base - 24-28½"H.



- A Unite Leg Bases - 28½"H**
- |           |                     |          |
|-----------|---------------------|----------|
| PLTULEG24 | (For 24"D Tops)     | \$326.00 |
| PLTULEG30 | (For 30"D Tops)     | \$341.00 |
| PLTULEG36 | (For 36"D Tops)     | \$464.00 |
| PLTULEG48 | (For (2) 24"D Tops) | \$492.00 |
| PLTULEG60 | (For (2) 30"D Tops) | \$522.00 |
- Available in BK Matte Black or SI Silver

- B Unite Leg Bases - 41"H**
- |               |                 |          |
|---------------|-----------------|----------|
| PLTULEG2441A1 | (For 24"D Tops) | \$375.00 |
| PLTULEG3041   | (For 30"D Tops) | \$384.00 |
| PLTULEG3641   | (For 36"D Tops) | \$506.00 |
- Available in SI Silver  
Note: 41"H Legs require additional PLTADJMDB4872 adjustable beam.

- C Unite Adjustable Height Leg Bases - 24 - 28½"H**
- |              |                 |              |
|--------------|-----------------|--------------|
| PLTULEG2485H | (For 24"D Tops) | \$362.00 ea. |
|--------------|-----------------|--------------|
- Available in BK Matte Black or SI Silver

**OPTIONAL CASTERS**  
Optional Leg Casters  
(For Unite Adj. Height Leg Bases Only)  
PLTULEGCASTERS  
List: \$65.00  
Available in BK Black

### DESK RISERS

Desk risers are used when using modular storage.

- D Desk Riser**
- |           |                        |          |
|-----------|------------------------|----------|
| PLTDR2430 | (For 24"D & 30"D Tops) | \$207.00 |
|-----------|------------------------|----------|
- Available in BK Matte Black or SI Silver  
Note: PLTCBBSINGLE is included with the desk riser.
- E Low Desk Riser - 3¼"H**
- |            |                        |          |
|------------|------------------------|----------|
| PLTLDR2430 | (For 24"D & 30"D Tops) | \$174.00 |
|------------|------------------------|----------|
- Available in BK Matte Black or SI Silver



### BEVELED STYLE LEG BASES

- F Beveled Leg Bases - 28¾"H**
- |            |                     |          |
|------------|---------------------|----------|
| PLTLEGBV24 | (For 24"D Tops)     | \$448.00 |
| PLTLEGBV30 | (For 30"D Tops)     | \$501.00 |
| PLTLEGBV36 | (For 36"D Tops)     | \$626.00 |
| PLTLEGBV48 | (For (2) 24"D Tops) | \$750.00 |
| PLTLEGBV60 | (For (2) 30"D Tops) | \$827.00 |
- Available in BK Matte Black or SI Silver

### OFFSET SQUARE POST LEG

Offset post legs are used for 120° desk tops & other freestanding/training tables

- G Offset Square Leg**
- |              |  |       |
|--------------|--|-------|
| PLTSQPOSTLEG |  | 28½"H |
|--------------|--|-------|
- List: \$253.00 ctn.  
Available in BK Matte Black or SI Silver  
Note: Priced and sold as (2) per carton.



### REQUIRED SUPPORTS



- Adjustable Beam**  
PLTADJMDB4872  
(Extends for Desks 48-72"W)  
List: \$181.00 ea.
- PLTADJMDB7896  
(Extends for Desks 78-96"W & 48"W Bridge Tops)  
List: \$224.00 ea.



- Beam Cover**  
PLTMDB72C  
(Cover to Conceal Adj. Beam & Hardware - For 72"W Tops Only)  
List: \$154.00 ea.



- Return Bracket**  
PLTRBB (For Adjustable Beams)  
List: \$64.00 ea.  
Note: Includes (2) PLTFB.



- Connector Beam Bracket**  
PLTCBBSINGLE  
(Required For Unite Leg Bases)  
List: \$56.00 ea.  
Note: 1 or 2 required depending on usage.



- Connector Beam Bracket**  
PLTCBBEV  
(Required For Beveled Leg Bases)  
List: \$83.00 ea.  
Note: 1 or 2 required depending on usage.

Note: All bases require beams & brackets. See Page 119.



# VARIANT

## OBLIQUE STYLE BASES

Oblique Legs available in two heights: 28½" & 41"H. Oblique legs sold separately from leg mounts.

Note: Please be sure to order both legs and mounts at time of purchase.



Metal Oblique Legs With Mounts

Wood Oblique Legs With Mounts

Metal 41"H Oblique Legs With Mounts & Support Leg Kit

### A Oblique Leg Bases - 28½"H

<b>PLTVAMETLEG</b>	(Metal Legs)	\$140.00
<b>PLTVAWLEG</b>	(Wood Legs)	\$154.00

Available in BK Matte Black, SI Silver, MW Modern Walnut & CG Coastal Gray.

Note: Oblique legs require PLTVALEGM leg mounts.

### B Oblique Leg Bases - 41"H

<b>PLTVAMETLEG41A1</b>	(Metal Legs)	\$191.00
------------------------	--------------	----------

Available in BK Matte Black or SI Silver

Note: 41"H Metal Oblique Legs require support leg kits. Legs require at least (2) Adjustable Beams when used.

## REQUIRED SUPPORTS - 41"H LEGS

Support Leg Kit (For 41"H Oblique Legs Only)

<b>PLTVALEGM243041CB</b>	(24-30")	\$245.00
<b>PLTVALEGM364241CB</b>	(36-42")	\$332.00
<b>PLTVALEGM486041CB</b>	(48-60")	\$451.00

Available in BK Matte Black or SI Silver

Note: Contains cross beam & leg mount.



28½"H

28½"H

## ADDITIONAL SUPPORTS

### G Return Support

<b>PLTRET SUPPORT</b>	10½"W x 7"D x 2½"H	List: \$87.00 ea.
-----------------------	--------------------	-------------------



Includes (2) Flat Plates

Return supports are to make a table under 48" or any other configuration where a beam cannot be used due to shorted or odd lengths.

### H Stiffener Support

<b>PLT60MSBK</b>	(For 60"D Tops)	List: \$112.00 ctn.
------------------	-----------------	---------------------

<b>PLT72MSBK</b>	(For 72"D Tops)	List: \$140.00 ctn.
------------------	-----------------	---------------------

Stiffener is a beam used to prevent any sagging of table tops. Note: PLT60MSBK & PLT72MSBK priced (2) per carton.



H

### I Flat Bracket

<b>PLTFBBK</b>	List: \$28.00 ea.
----------------	-------------------



Note: Flat Bracket can be shipped by a small package carrier.

## HALF & INSET LEGS

### E Half Leg - 28½"H

<b>PLTULEGHALF</b>	\$271.00
--------------------	----------

(For 24"D & 30"D Tops)  
Available in BK Matte Black or SI Silver

Ideal For Shared Single Depth Work Surfaces. Allows More Leg Room.

### F Inset Leg - 28½"H

<b>PLTULEG4860ILCMB</b>	\$737.00
-------------------------	----------

(Includes a removable wire management cover & PLTMBMBC Brackets)  
Available in SI Silver

Ideal For Shared Double Depth Work Surfaces. Allows More Leg Room.



Pictured w/Willow Seating & NEW! OSTYP330 Typical

Inset Legs Pair Well With Unite Leg Bases

Metal Leg Base Finishes



BK Black

SI Silver

Wood Leg Base Finishes



CG Coastal Gray

MW Modern Walnut

## REQUIRED SUPPORTS



**Adjustable Beam**  
**PLTADJMDB4872**  
(Extends for Desks 48-72"W)  
List: \$181.00 ea.

**PLTADJMDB7896**  
(Extends for Desks 78-96"W & 48"W Bridge Tops)  
List: \$224.00 ea.



**Beam Cover**  
**PLTMDB72C**  
(Cover to Conceal Adj. Beam & Hardware - For 72"W Tops Only)  
List: \$154.00 ea.



**Return Bracket**  
**PLTRBB** (For Adjustable Beams)  
List: \$64.00 ea.  
Note: Includes (2) PLTFB.



**Oblique Leg Mounts**  
**PLTVALEGM2430**  
(For 24-30"D Tops)  
List: \$140.00 ea.

**PLTVALEGM3642**  
(For 36-42"D Tops)  
List: \$169.00 ea.

**PLTVALEGM4860**  
(For 48-60"D Tops)  
List: \$253.00 ea.

Note: Required for both Metal & Wood Oblique Legs.



**Connector Beam Bracket**  
**PLTMBMBC** (Pair)  
(Required For Oblique Only When Shared)  
List: \$70.00 ea.

Note: All bases require beams & brackets. See Page 119.

## VARIANT



### RECTANGULAR DESK TOPS

PLT2436†	36"W x 24"D	\$315.00
PLT2448†	48"W x 24"D	\$360.00
PLT2460†	60"W x 24"D	\$405.00
PLT2466†	66"W x 24"D	\$443.00
PLT2472†	72"W x 24"D	\$443.00
PLT3048†	48"W x 30"D	\$393.00
PLT3060†	60"W x 30"D	\$487.00
PLT3066†	66"W x 30"D	\$519.00
PLT3072†	72"W x 30"D	\$519.00
PLT3672†	72"W x 36"D	\$628.00



### RETURN TOPS

<b>(36 - 48" Wide)</b>		
PLT2436†	36"W x 24"D	\$315.00
PLT2442†	42"W x 24"D	\$344.00
PLT2448†	48"W x 24"D	\$360.00
<b>(60 - 72" Wide)</b>		
PLT2460†	60"W x 24"D	\$405.00
PLT2466†	66"W x 24"D	\$443.00
PLT2472†	72"W x 24"D	\$443.00



### BULLET TOPS

PLT131T	66"W x 30"D	\$472.00
PLT147T	72"W x 36"D	\$578.00

PLT131T is available in ES Espresso, MA Maple, MW Modern Walnut & CG Coastal Gray Only.

PLT147T is available in ES Espresso, MA Maple, MW Modern Walnut & CG Coastal Gray Only.

Note: Rectangular Desk & Return Tops Require Beams & Brackets. See Page 119.



### RECTANGULAR GLASS TOPS

PGT2460	60"W x 24"D	\$1,050.00
---------	-------------	------------

Note: Glass tops work with 24"D Unite Legs & 24"D Beveled Legs Only.

Available in BK Black Tempered Glass



PGT2460 Shown w/24" Beveled Legs in Silver



PGT2460 Shown w/24" Unite Legs in Silver

## CABLE MANAGEMENT ACCESSORIES

**CMS03** (Spine)  
30" Flexible Cord Concealer \$103.00  
Available in SI Silver

**OSWTSINGLE**  
18" Single Wire Mesh Tray \$239.00  
Available in BK Black

**PLTPC18**  
18" Power Trough w/Cover \$93.00  
Available in BK Black



Easily Conceal Your Troublesome Wires & Cords With A Flexible 30" Spine Cord Concealer!

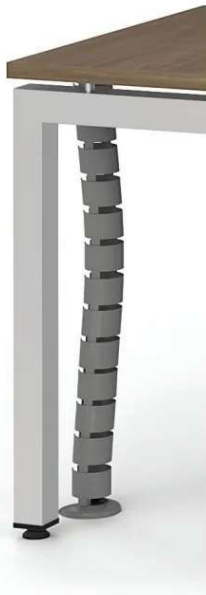

## MODESTY PANELS

**Metal Perforated Modesty Panels - 1½"D x 15"H**  
(18"H w/Included Brackets)

MMP1853	53" Wide	\$183.00
MMP1865	65" Wide	\$213.00

Available in BK Matte Black & SI Silver

**Laminate Modesty Panels - ¾"D x 18"H**

PLTLMP54	54" Wide	\$240.00
PLTLMP66	66" Wide	\$255.00

Available in CH Cherry, MH Mahogany, ES Espresso, MA Maple, MW Modern Walnut, CG Coastal Gray & WH White Only.

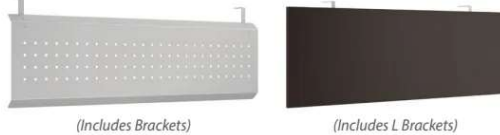

(Includes Brackets)

(Includes L Brackets)



Pictured w/Laminate Modesty Panel - OS237 Typical



Note: American Elm only available for select SKUs. Select SKUs are notated by a † mark at the end of their SKU.



## VARIANT

### LAMINATE LATERALS



#### 2 Drawer Cabinet

**PL1012†\***

35½"W x 22"D x 22"H  
List: \$1,359.00

\*PL1012 & PL2013 - Top not included. Requires PL109 or PL110 if freestanding.



#### Open Shelf Cabinet

**PL2013†\***

35½"W x 22"D x 22"H  
List: \$824.00



#### File Top (For PL1012 or PL2013)

**PL109† - 35½"W**

List: \$239.00

#### Credenza Top (For PL1012 or PL2013)

**PL110† - 71"W**

List: \$325.00

PL110 sits on top of/can be applied to (2) PL112, (2) PL172, PL113, PL1012, PL2013 or PL152.

Note: PL109 is available in **NEW!** AE American Elm, ES Espresso, MW Modern Walnut, CG Coastal Gray & WH White Only.

Laminate finishes available in **NEW!** AE American Elm, CH Cherry, MH Mahogany, ES Espresso, MA Maple, MW Modern Walnut, CG Coastal Gray & WH White.



#### Top Cushion

**CUSH2136\*\***

List: \$445.00

\*\*Requires PL109 or PL110

Available in BL Celestial Blue & GK Dark Gray

### LAMINATE PEDESTALS



#### A PL166† (Box/Box/File)

15½"W x 22"D x 28½"H  
List: \$696.00



Mobile Laminate Pedestal w/Optional Top Cushion

#### B PL175† (File/File)

15½"W x 22"D x 28½"H  
List: \$714.00



#### C Mobile Laminate Pedestal

**PL1007† (Box/File)**

(Casters Included)

16"W x 22½"D x 22½"H  
List: \$769.00

#### D Pedestal Top Cushion

**CUSH1623 (For PL1007)**

List: \$237.00

Available in BL Celestial Blue & GK Dark Gray



BL Celestial Blue



GK Dark Gray

Laminate finishes available in **NEW!** AE American Elm, CH Cherry, MH Mahogany, ES Espresso, MA Maple, MW Modern Walnut, CG Coastal Gray & WH White.

### METAL LATERALS



#### 2 Drawer Cabinet

**836BF - 35½"W x 19¾"D x 20"H**  
List: \$1,286.00

Available in SI Silver

Note: Cabinets stand at 23"H with casters or legs.



#### Heavy-Duty Casters

**83CASTERS (Set of 4)**  
List: \$147.00



#### Metal Legs

**83SL (Set of 4)**  
List: \$85.00

Note: 83CASTERS & 83SL can be shipped by a small package carrier.

### METAL PEDESTALS



#### Metal Pedestals

**CPSBBF (Box/Box/File)**

**CPSFF (File/File)**

15"W x 22"D x 26¾"H  
List: \$676.00 ea.



#### Mobile Metal Pedestal

**CPSBF**

(Casters Included)

15"W x 22"D x 22½"H  
List: \$602.00

Includes counter weights on all metal pedestal units

#### Pedestal Top Cushion

**CUSH1522 (For CPS Peds)**

List: \$221.00

Available in BL Celestial Blue & GK Dark Gray

Available in BK Black, CR Charcoal, GT Light Gray, SI Silver & WH White.  
CPSBF: WH White, BK Black & SI Silver Only.



#### Optional Casters (Set of 4)

**CPPCASTERS**

List: \$54.00

### MINI LEG BASES



#### Angled Wood Mini Legs

**PLTAWRLEG (Set of 4)**

List: \$120.00

Available in NO Natural Oak, MW Modern Walnut & CG Coastal Gray.



#### Straight Metal Mini Legs

**PLTSMRLEG (Set of 4)**

List: \$171.00

Available in BK Matte Black or SI Silver

Note: Mini Legs can be shipped by a small package carrier.

Note: American Elm **only** available for select SKUs. Select SKUs are notated by a † mark at the end of their SKU.



Pictured w/CoolMesh Seating & **NEW!** OSTYP302 Typical

## VARIANT



NEW! OSTYP324 Typical



NEW! OSTYP301 Typical



NEW! OSTYP311 Typical  
(w/Optional Wall Hutch - Not Included)

## WALL MOUNTED OPEN HUTCHES



Open Hutch (31 or 36 1/2" Wide)



Open Hutch (71" Wide)

### Open Hutch - 31"W

**PL209OH**

15"D x 17"H  
List: \$519.00

Note: Doors not included.

### Open Hutch - 36 1/2"W

**PL208OH†**

15"D x 17"H  
List: \$562.00

Note: Doors not included.

### Open Hutch - 71"W

**PL2044OH†**

15"D x 17"H  
List: \$946.00

Note: Doors not included.

Available in NEW! AE American Elm,  
CH Cherry, MH Mahogany, ES Espresso, MA Maple,  
MW Modern Walnut, CG Coastal Gray & WH White.

## OPEN HUTCHES & REQUIRED SUPPORTS



Pictured w/NEW! OSTYP310 Typical

### A Open Hutch (Requires Supports)

**PL1044OH†** 71"W x 15"D x 17"H \$950.00

Note: Doors & supports not included.

Note: PL1044OH is not compatible with the optional sliding glass doors.

### B Hutch Supports (Pair)

**PLTLPHS27-27"H** \$405.00

**PLTLPHS20-20"H** \$341.00

Available in BK Matte Black or SI Silver



Pre-drilled holes  
for easy support  
assembly.

## OPTIONAL HUTCH DOORS



### Optional Laminate Doors

**PL41LD†** (For PL209 & PL141 - Set of 2)

List: \$80.00

**PL44LD†\*** (Set of 2)

List: \$83.00

\*Note: All hutch door SKUs beginning with PL44 are for PL144OH, PL1044OH, PL2044OH & PL208OH.

Available in NEW! AE American Elm, CH Cherry, MH Mahogany, ES Espresso, MA Maple, MW Modern Walnut, CG Coastal Gray & WH White.

Note: American Elm only available for select SKUs. Select SKUs are notated by a † mark at the end of their SKU.



### Optional Silver Framed Glass Doors

**PL41SGD** (For PL209 & PL141)

**PL44SGD\*** (Set of 2)

List: \$373.00 ea.



### Optional Sliding Glass Doors

**PL44SLIDESGD\*** (2 Door Span)

List: \$256.00

**PL44RAIL** (Rails for PL144OH & PL2044OH)

List: \$150.00

Note: PL1044OH are not compatible with the sliding glass doors.

## OPTIONAL LOCK



### Hutch Door Lock

**PLLDLOCKKIT**

List: \$59.00 ea.

Available in BK Black or SI Silver



# VARIANT



**L Shape Typical**  
**OS217†**  
 Total List: \$4,121.00  
 72"W x 71"D x 29½"H  
 Excludes Accessories

**72" x 71" Unite Leg L Shape Workstation:**

Rectangular Top: PLT3072†, Unite Leg Base: PLTULEG30, Adjustable Beam: PLTADJMDB4872, Connector Beam Bracket: PLTCBBSINGLE, Low Desk Riser: PLTLDR2430, Open Shelf Cabinet: PL2013†, 2 Drawer Personal Cabinet: PL1012†, Credenza Top: PL110†, Straight Metal Mini Legs: PLTSMRLEG (2).

**OS217 | Components**



**ADDITIONAL COLLECTION OPTIONS**



**Straight Metal Mini Legs**  
**PLTSMRLEG** (Set of 4)  
 List: \$171.00  
 Available in BK Matte Black or SI Silver



**Low Desk Riser - 3¼"H**  
**PLTLDR2430** (For 24"D & 30"D Tops)  
 List: \$174.00  
 Available in BK Matte Black or SI Silver

Note: Mini Legs can be shipped by a small package carrier.



NEW! AE American Elm (†Select SKUs)   CG Coastal Gray   ES Espresso   MW Modern Walnut   MH Mahogany   CH Cherry   WH White   MA Maple

Note: American Elm only available for select SKUs. Select SKUs are notated by a † mark at the end of their SKU.

# VARIANT



**NEW! L Shape Typical**

**OSTYP311†**

Total List: \$3,889.00

72"W x 78"D x 29½"H

Excludes Seating & Accessories

Pictured w/Franklin Seating

**72" x 78" Unite Leg L Shape Workstation:**

Rectangular Tops: PLT3072† & PLT2448†, Unite Leg Bases: PLTULEG30 (2) & PLTULEG24, Adjustable Beams: PLTADJMDB4872 (2), Connector Beam Brackets: PLTCBBSINGLE (3), Return Bracket: PLTRBB, Flat Brackets: PLTFB (2), Pedestals: CPSBBF (2).



**NEW! OSTYP311 | Components**



**NEW! AE American Elm**  
(†Select SKUs)

**CG Coastal Gray**

**ES Espresso**

**MW Modern Walnut**

**MH Mahogany**

**CH Cherry**

**WH White**

**MA Maple**

Note: American Elm **only** available for select SKUs. Select SKUs are notated by a † mark at the end of their SKU.



# VARIANT



**NEW! Multi-Person Typical OSTYP303†**  
 Total List: \$12,754.00  
 144"W x 72"D x 54"H  
 Excludes Seating & Accessories  
 Pictured w/Franklin Seating

## 144" x 72" Unite Leg Multi-Person Workstation:

Rectangular Tops: PLT2472† (4) & PLT2448† (4), Unite Leg Bases: PLTULEG48 (5), Adjustable Beams: PLTADJMDB4872 (8), Connector Beam Brackets: PLTCBBSINGLE (12), Return Brackets: PLTRBB (4), Frosted Acrylic Shields: PLTAP2466S (2), Shield Brackets: PLTSBUDMDUAL (2), Mobile Pedestal: PL1007† (4), Flat Brackets: PLTFB (8).



## NEW! OSTYP303 | Components (For 4 Workstations Pictured Above)



Note: American Elm only available for select SKUs. Select SKUs are notated by a † mark at the end of their SKU.

# VARIANT



Multi-Person Typical  
 OS236†  
 Total List: \$20,616.00  
 216"W x 60"D x 54"H  
 Excludes Seating & Accessories  
 Pictured w/Cade Seating

## 216" x 60" Oblique Leg Multi-Person Workstation:

Rectangular Tops: PLT3072† (6), Oblique Metal Leg Bases: PLTVAMETLEG (6), Leg Mounts: PLTVALEGM4860 (6), Adjustable Beams: PLTADJMDB4872 (6), Clear Acrylic Shields: QSACRV2454C (3), Shield Brackets: PLTSBUDMDUAL (3), 2 Drawer Personal Cabinets: PL1012† (6), Cabinet Tops: PL109† (6), Top Cushions: CUSH2136 (6).



### QSOS236 | Components (For 6 Workstations Pictured Above)



QS = QUICKSHIP

Note: PL109 is **not available** in CH Cherry, MA Maple & MH Mahogany.



# VARIANT



**Simple Typical  
OS237**  
Total List: \$3,356.00  
72"W x 36"D x 29½"H  
Excludes Seating & Accessories  
Pictured w/Sierra & Manhattan Seating

**72" x 36" Oblique Metal Leg Workstation:**

Rectangular Top: PLT3072†, Oblique Metal Leg Bases: PLTVAMETLEG (2), Leg Mounts: PLTVALEGM2430 (2), Adjustable Beam: PLTADJMDB4872, 2 Drawer Lateral File: PL112†, Laminate Modesty Panel: PLTLMP54 & Open Hutch: PL153†.



**OS237 | Components**



Note: American Elm only available for select SKUs. Select SKUs are notated by a † mark at the end of their SKU.

# VARIANT



**L Shape Typical OS216†**  
 Total List: \$4,008.00  
 72"W x 71"D x 29½"H  
 Excludes Accessories  
 w/Optional Modern Pulls

## 72" x 71" Oblique Leg L Shape Workstation:

Rectangular Top: PLT3072†, Oblique Wood Leg Base: PLTVAWLEG, Adjustable Beam: PLTADJMDB4872, Leg Mount: PLTVALEGM2430, Low Desk Riser: PLTLDR2430, Open Shelf Cabinet: PL2013†, 2 Drawer Personal Cabinet: PL1012†, Credenza Top: PL110†, Angled Wood Mini Legs: PLTAWRLEG (2), Metro Pulls: OSPULLCYLBK (2).

## OS216 | Components



## ADDITIONAL COLLECTION OPTIONS



### Angled Wood Mini Legs

**PLTAWRLEG** (Set of 4)

List: \$120.00

Available in **NO** Natural Oak, **MW** Modern Walnut & **CG** Coastal Gray.



### Low Desk Riser - 3¼"H

**PLTLDR2430** (For 24"D & 30"D Tops)

List: \$174.00

Available in **BK** Matte Black or **SI** Silver

Note: Mini Legs can be shipped by a small package carrier.

Note: **PLTVAWLEG** is not available in the **NO** Natural Oak.



**NEW! AE** American Elm  
 (†Select SKUs)

**CG** Coastal Gray

**ES** Espresso

**MW** Modern Walnut

**MH** Mahogany

**CH** Cherry

**WH** White

**MA** Maple

Note: American Elm only available for select SKUs. Select SKUs are notated by a † mark at the end of their SKU.



# VARIANT



**NEW! Multi-Person Typical**  
**QSOSTYP301†**  
 Total List: \$11,388.00  
 144"W x 72"D x 65½"H  
 Excludes Seating & Accessories  
 Pictured w/CoolMesh Pro Seating

## 144" x 72" Unite Leg Two-Person Workstation:

Rectangular Top: PLT3072† (2), Unite Leg Bases: PLTULEG30 (2), Adjustable Beam: PLTADJMDB4872 (2), Desk Riser: PLTDR2430 (2), Open Shelf Cabinet: PL2013† (2), 2 Drawer Personal Cabinet: PL1012† (2), Credenza Top: PL110† (2), Open Hutch: PL1044OH† (2), Hutch Supports: PLTLPHS27 (2), Laminate Hutch Doors: PL44LD† (Set of 2) - (2), Connector Beam Brackets: PLTCBBSINGLE (2), Shield Brackets: PLTSBUDMSGL (Set of 2) (2), Clear Acrylic Shields: QSACRV2430C (2).

## NEW! QSOSTYP301 | Components (For 2 Workstations Pictured Above)



## Additional Pull Options Customize Your Pull Options - See Page 35



Note: American Elm only available for select SKUs. Select SKUs are notated by a † mark at the end of their SKU.

# VARIANT



**NEW! L Shape Typical  
OSTYP325†**  
Total List: \$5,974.00  
72"W x 90"D x 65½"H  
Excludes Seating & Accessories  
Pictured w/Franklin & Framed Seating

## 72" x 90" Beveled Leg L Shape Workstation:

Rectangular Top: PLT3072†, Beveled Leg Base: PLTLEGBV30, Adjustable Beam: PLTADJMDB4872, Connector Beam Bracket: PLTCBBEV, Desk Riser: PLTDR2430, Open Shelf Cabinet: PL2013†, 2 Drawer Personal Cabinet: PL1012†, Credenza Top: PL110†, Open Hutch: PL1044OH†, Hutch Supports: PLTLPHS27, Laminate Hutch Doors: PL44LD† (Set of 2), Crescent Black Pulls: OSPULLHLBK (2), Magnetic Glass White Board: GBM1769.



## NEW! OSTYP325 | Components

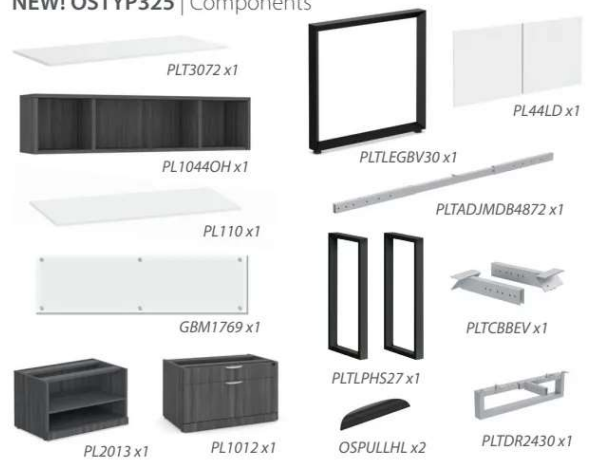

**NEW! AE American Elm** (†Select SKUs)   **CG Coastal Gray**   **ES Espresso**   **MW Modern Walnut**   **MH Mahogany**   **CH Cherry**   **WH White**   **MA Maple**

Note: American Elm only available for select SKUs. Select SKUs are notated by a † mark at the end of their SKU.



# VARIANT



**NEW! Multi-Person Typical  
OSTYP321†**  
Total List: \$7,915.00  
144"W x 50"D x 29½"H  
*Excludes Seating & Accessories*  
*Pictured w/NEW! Orion Seating*

### NEW! OSTYP321 | Components

SKU #	QTY	DESCRIPTION	W x D x H
PL1012†	2	2 Drawer Personal Cabinet	35½ x 22 x 22
PL2013†	2	Open Shelf Cabinet	35½ x 22 x 22
PL110†	2	File/Storage Top	71 x 22 x 1
PLT3072†	2	Rectangular Top	72 x 30 x 1
PLTDR2430	2	Desk Riser	23¾ x 2 x 6½
PLTULEG60	1	Unite Leg Base (For 36"D Tops)	60 x 1¼ x 28½
PLTCBBSINGLE	2	Connector Beam Bracket	
PLTADJMDB4872	2	Adjustable Beam	67¾ x 2 x 1
PLTSBUDMDUAL	1	Shield Bracket (Set of 2)	
PLTFP1566	1	Fabric Shield	66 x ½ x 15



**NEW! Multi-Person Typical  
OSTYP300†**  
Total List: \$17,938.00  
144"W x 144"D x 44½"H  
*Excludes Seating & Accessories*  
*Pictured w/Franklin & Integrate Seating*

### NEW! OSTYP300 | Components

SKU #	QTY	DESCRIPTION	W x D x H
PL1012†	4	2 Drawer Personal Cabinet	35½ x 22 x 22
PL2013†	4	Open Shelf Cabinet	35½ x 22 x 22
PL110†	4	File/Storage Top	71 x 22 x 1
CUSH2136	4	Top Cushion	35½ x 22 x 1½
PLTLEGBV48	2	Beveled Leg Base	48 x 3 x 28¾
PLTCBBEV	4	Connector Beam Bracket	
PLTDR2430	4	Desk Riser	23¾ x 2 x 6½
PLTADJMDB4872	4	Adjustable Beam	67¾ x 2 x 1
PLT2472†	4	Rectangular Top	72 x 24 x 1
PLTSBUDMDUAL	2	Shield Bracket (Set of 2)	
PLTAP1566S	2	Frosted Acrylic Shield	66 x ¼ x 15



**NEW! Multi-Person Typical  
OSTYP302†**  
Total List: \$13,768.00  
144"W x 144"D x 65½"H  
*Excludes Seating & Accessories*  
*Pictured w/CoolMesh Seating*

### NEW! OSTYP302 | Components

SKU #	QTY	DESCRIPTION	W x D x H
PLT2472†	4	Rectangular Top	72 x 24 x 1
PLT2448†	4	Rectangular Top	48 x 24 x 1
PLTLEGBV48	3	Beveled Leg Base	48 x 3 x 28¾
PLTLEGBV24	4	Beveled Leg Base	24 x 3 x 28¾
PLTADJMDB4872	8	Adjustable Beam	67¾ x 2 x 1
PLTCBBEV	12	Connector Beam Bracket	
PLTRBB	4	Return Bracket	
PLTSBUDMDUAL	2	Shield Bracket (Set of 2)	
PLTAP2466S	2	Frosted Acrylic Shield	66 x ¼ x 24
CPSBF	4	Mobile Metal Pedestal - B/F	15 x 22 x 22¼



## STANDUP STANDING DESKS

Pictured w/NEW! OSTYP319 Typical - Page 81

### Avoid The Harmful Long-Term Effects Of Too Much Sitting...

Health authorities recommend changing posture from a sitting to standing position throughout the day. Standing desks can help achieve this at the office.

OfficeSource® StandUp Standing desks are easy, quick and quiet to operate and offer the optimal vertical range to accommodate people of all sizes.



Pictured w/Acrylic Privacy Shields & Silver Brackets - Variation of OS228

Seven Base Options

Two Top Shapes

Several Top Sizes

Eight Top Finishes

Configure *Your Way!*

#### Adjustable Height Ranges:

- 2-Stage Electric - 27 $\frac{1}{2}$ " - 44 $\frac{1}{2}$ "
- 3-Stage Electric - 24 $\frac{1}{2}$ " - 50"
- Corner Electric - 24 $\frac{1}{2}$ " - 50"
- Crank Lift - 26 $\frac{1}{4}$ " - 42 $\frac{3}{4}$ "
- Pneumatic Lift - 27" - 42 $\frac{1}{2}$ "
- Laminate Deluxe Casing - 24 $\frac{1}{2}$ " - 50"
- 2-Stage Single Motor - 25 $\frac{1}{2}$ " - 45 $\frac{1}{2}$ "



#### Laminate Top Finishes



NEW! AE American Elm  
(†Select SKUs)

CG Coastal Gray

ES Espresso

MW Modern Walnut

MH Mahogany

CH Cherry

WH White

MA Maple

#### Metal Base Finishes



BK Black  
(Select SKUs)

SI Silver

Note: American Elm **only** available for select SKUs. Select SKUs are notated by a † mark at the end of their SKU.



# STANDUP STANDING DESKS

Custom Build Your Standing Workstation By Combining Table Tops & Bases

## ADJUSTABLE HEIGHT BASES

Seven different options to choose from. See Page 78 for details.

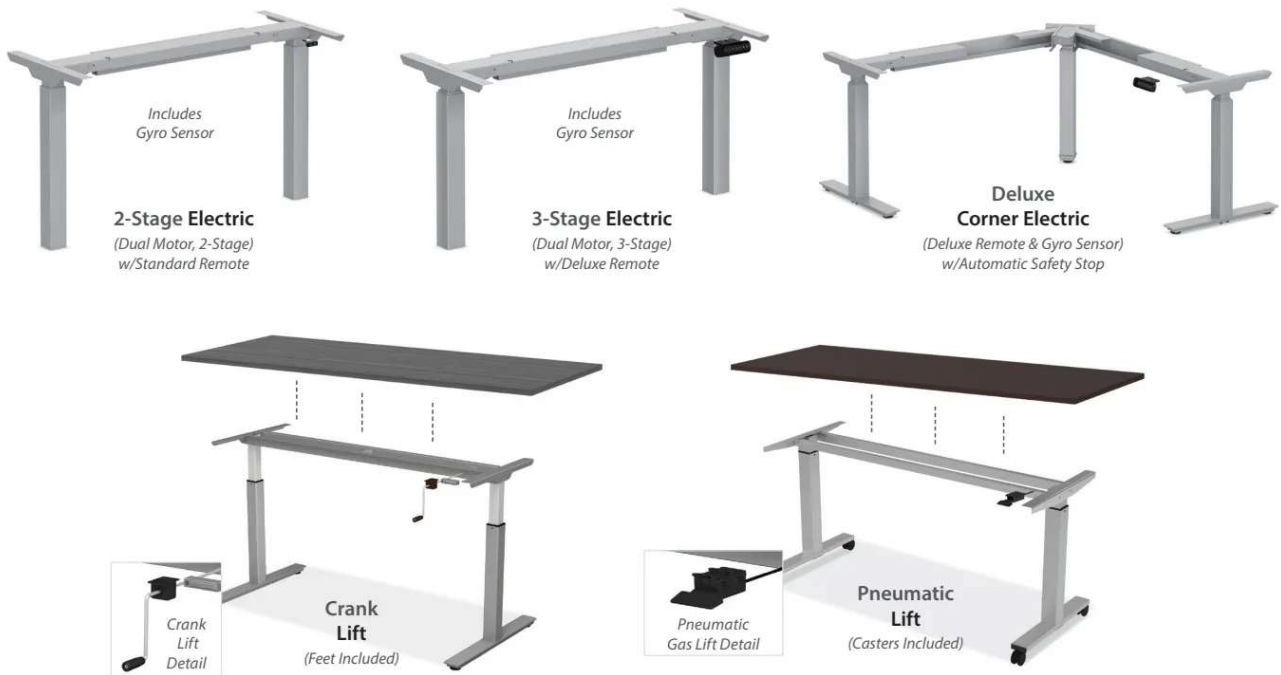

**Laminate Deluxe Casing**  
For Executive Offices Or When  
You Would Like To Hide  
The StandUp Base Frame



## SEVERAL TOP SHAPES & SIZES

Two top shapes, several different sizes & eight top finishes to choose from. See Page 79 for details.



Note: American Elm **only** available for select SKUs. Select SKUs are notated by a † mark at the end of their SKU.

Note: PLT131T Available In ES Espresso, MA Maple, MW Modern Walnut & CG Coastal Gray Only.  
PLT147T Available in ES Espresso, MA Maple, MW Modern Walnut & CG Coastal Gray Only.

# STANDUP STANDING DESKS



**A 2-Stage Electric Base w/Standard Remote**  
 (For 24"D & 30"D Tops)  
**PLTEAB4872BUDECONF\***  
 46 $\frac{5}{8}$ "-70"W x 29 $\frac{1}{16}$ "D x 27 $\frac{3}{16}$ "-44 $\frac{1}{2}$ "H  
 List: \$1,579.00  
 Note: A-B Accommodates 48"W to 72"W table tops.  
 Note: Must Order Standard or Mobile Feet with A & B bases.

**B 3-Stage Electric Base w/Deluxe Remote**  
 (For 24"D & 30"D Tops)  
**PLTEAB4872ECONF\***  
 46 $\frac{5}{8}$ "-70"W x 29 $\frac{1}{16}$ "D x 24 $\frac{7}{16}$ "-50"H  
 List: \$1,985.00

**C Single Motor, 2 Stage Height Adjustable Table Base**  
**OSBHAT4860**  
 37 $\frac{3}{8}$ "-59"W x 23 $\frac{3}{8}$ "D x 25 $\frac{3}{4}$ "-45 $\frac{1}{2}$ "H  
 List: \$1,100.00  
 Note: OSBHAT4860 can be shipped by a small package carrier.

**D 3-Stage, Electric Corner Base**  
**PLTECAB6078ECOWF\***  
 54-69 $\frac{1}{16}$ "W x 69 $\frac{1}{16}$ "D x 24 $\frac{3}{8}$ "-50"H  
 List: \$2,954.00  
 Note: Accommodates 60"W to 78"W table tops w/return tops 36"W to 48"W or 72"W x 78"W with a corner top.

**E Crank Lift Bases**  
**PLTCRKB36WF24**  
 (For 24"D Tops)  
 35"W x 23 $\frac{1}{2}$ "D x 26-42 $\frac{3}{4}$ "H  
**PLTCRKB36WF30**  
 (For 30"D Tops)  
 35"W x 29 $\frac{1}{2}$ "D x 26-42 $\frac{3}{4}$ "H  
 List: \$1,156.00  
 Note: Accommodates 36"W to 48"W table tops.  
**PLTCRKB60WF24**  
 (For 24"D Tops)  
 58 $\frac{1}{4}$ "W x 23 $\frac{1}{2}$ "D x 26-39 $\frac{1}{2}$ "H  
**PLTCRKB60WF30**  
 (For 30"D Tops)  
 58 $\frac{1}{4}$ "W x 29 $\frac{1}{2}$ "D x 26-39 $\frac{1}{2}$ "H  
 List: \$1,211.00  
 Note: Accommodates 60"W to 72"W table tops.

**F Pneumatic Height Base w/Casters**  
**PLTPHAB2460WF**  
 (For 24"D Tops)  
 60"W x 24"D x 27-42 $\frac{3}{4}$ "H  
 List: \$1,249.00  
**PLTPHAB3060WF**  
 (For 30"D Tops)  
 60"W x 30"D x 27-42 $\frac{3}{4}$ "H  
 List: \$1,327.00  
 Note: Accommodates 60"W table tops.

**G Laminate Desk Casings**  
 (Includes Electric Adjustable Base & Rectangular Top)  
**PLTHAT5172†**  
 72"W x 75 $\frac{1}{2}$ "D x 26 $\frac{3}{16}$ "-49 $\frac{1}{8}$ "H  
 List: \$3,605.00  
 PLTHAT5172 Available In **NEW!** AE American Elm, CH Cherry, MH Mahogany, ES Espresso, MA Maple, MW Modern Walnut, CG Coastal Gray & WH White Only.  
 Note: American Elm **only** available for select SKUs. Select SKUs are notated by a † mark at the end of their SKU.  
 Note: 83CASTERS can be shipped by a small package carrier.

Some items in this collection come ready-to-assemble.

**OPTIONAL CASTERS - (FOR BASES A & B)**

**Optional Casters**  
 (For Use With PLTHATFEET24 & 30)  
**83CASTERS** (Set Of 4)  
 List: \$147.00

**OPTIONAL ACCESSORIES**

**Programmable Remote w/USB Charger**  
 (For A Electric Base Only)  
**PLTECODLXHANDSET**  
 List: \$136.00

**Battery Pack**  
 (For A, B & D Electric Bases Only)  
**PLTECOBATTERY**  
 List: \$610.00

## FEET OPTIONS - (FOR BASES A & B)

**Standard Feet** (Set of 2)  
**PLTHATFEET24**  
 23 $\frac{3}{8}$ "W x 3 $\frac{1}{8}$ "D x 1 $\frac{1}{2}$ "H  
**PLTHATFEET30**  
 29 $\frac{1}{2}$ "W x 3 $\frac{1}{8}$ "D x 1 $\frac{1}{2}$ "H  
 List: \$181.00

**Single Adapter Foot w/Spacer**  
 (When Combining Base With PL2013 + PL109HAT or PL110HAT)  
**PLTADAPTHATFOOT24**  
**PLTADAPTHATFOOT30**  
 List: \$131.00





# STANDUP STANDING DESKS

Choose Work Surface Style, Size & Shape (Rectangular & Bullet Top)



## Rectangular Tops

PLT2448†	48"W x 24"D	\$360.00
PLT2460†	60"W x 24"D	\$405.00
PLT2466†	66"W x 24"D	\$443.00
PLT2472†	72"W x 24"D	\$443.00
PLT3048†	48"W x 30"D	\$393.00
PLT3060†	60"W x 30"D	\$487.00
PLT3066†	66"W x 30"D	\$519.00
PLT3072†	72"W x 30"D	\$519.00
PLT3672†	72"W x 36"D	\$628.00

## Rectangular Return Tops

PLT2436†	36"W x 24"D	\$315.00
PLT2442†	42"W x 24"D	\$344.00
PLT2448†	48"W x 24"D	\$360.00
PLT2460†	60"W x 24"D	\$405.00

## Bullet Tops

PLT131T	66"W x 30"D	\$472.00
PLT147T	72"W x 36"D	\$578.00

Note: PLT131T Available In ES Espresso, MA Maple, MW Modern Walnut & CG Coastal Gray Only.

Note: PLT147T Available in ES Espresso, MA Maple, MW Modern Walnut & CG Coastal Gray Only.



Pictured w/Hanging USB Mini Pedestal

## LAMINATE STORAGE

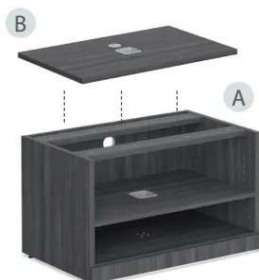

Or



### A Open Shelf Cabinet

(For Use With HAT Unit)

PL2013†	35½"W x 22"D x 22"H
List:	\$824.00

### B Optional HAT Top

(For PL2013)

PL109HAT	35½"W x 22"D x 1"H
List:	\$255.00
PL110HAT	71"W x 22"D x 1"H
List:	\$344.00

Note: PL109HAT & PL110HAT is available in ES Espresso, MW Modern Walnut & CG Coastal Gray Only.

Note: PL2013 comes with an extra shelf that has not been pre-holed for possible use without the HAT unit involved.



Pictured w/OS229 Typical

## MODESTY PANELS



(Includes Brackets)



(Includes L Brackets)

### Metal Perforated Modesty Panels - 1½"D x 15"H

(18"H w/Included Brackets)

MMP1853	53"Wide	\$183.00
MMP1865	65"Wide	\$213.00

Available in BK Matte Black & SI Silver

### Laminate Modesty Panels - ¾"D x 18"H

PLTLMP54	54"Wide	\$240.00
PLTLMP66	66"Wide	\$255.00

Available in CH Cherry, MH Mahogany, ES Espresso, MA Maple, MW Modern Walnut, CG Coastal Gray & WH White.

## MINI PEDESTALS



### Mini Pedestals

CMPBF (Box/File)

10"W x 20¼"D x 21"H	
List:	\$571.00

Available in BK Black, SI Silver & WH White

Metal & Laminate Pedestals  
See Pages 224-225



### Hanging Bracket w/USB

CMPHUSB (For CMPBF)

List:	\$242.00
-------	----------



### Pedestal Top Cushion

CUSH1019 (For CMPBF)

List:	\$216.00
-------	----------

Available in BL Celestial Blue & GK Dark Gray



Shown With Optional Top Cushion & Casters

### Optional Casters (Set of 4)

CPPCASTERS

List:	\$54.00
-------	---------



NEW! AE American Elm (†Select SKUs)

CG Coastal Gray

ES Espresso

MW Modern Walnut

MH Mahogany (Select SKUs)

CH Cherry (Select SKUs)

WH White

MA Maple (Select SKUs)

Note: American Elm only available for select SKUs. Select SKUs are notated by a † mark at the end of their SKU.



Height Adjustable Typical  
**OS164†**  
 Total List: \$8,047.00  
 Excludes Seating & Accessories  
 Pictured w/Sierra Seating

**STANDUP STANDING DESKS**

**FEATURES**

- **Reduce the Risk of Obesity** - Standing from time-to-time introduces a variety of natural little movements to your day.
- **Reduce the Risk of Disease** - Sitting for extended periods contributes to metabolic problems including type 2 diabetes.
- **Less Cardiovascular Disease** - Simply put, sitting all day is bad for the heart.
- **Lowered Cancer Risk** - Recent studies potentially link prolonged sitting with increased breast and colon cancer risks.

**OS164 | Components**

SKU #	QTY	DESCRIPTION	W x D x H
PLTHAT5172†	1	Laminate Desk Casing	72 x 30 x 27¼-51
PLTAP1554S	1	Frosted Acrylic Shield	54 x ¼ x 15
OSTB400	2	Desk Mount Shield Bracket	
PL112†	1	2 Drawer Lateral File	35½ x 22 x 29½
PL113†	1	Storage Cabinet	35½ x 22 x 29½
PL110†	1	File/Storage Top	71 x 22 x 1
PL1044OH†	1	Open Hutch	71 x 15 x 17
PL44SGD	1	Silver Frame Glass Doors	17 x ¾ x 15¾
PLTLPHS27	1	Hutch Supports (Set of 2)	27"H

**OS174 | Components**

SKU #	QTY	DESCRIPTION	W x D x H
PL143†	1	Credenza Shell	71 x 24 x 29½
PL114†	1	Combo Lateral File - B/B/F/Lat.	31 x 22 x 29½
PL144OH†	1	Open Hutch	72 x 15 x 36
PL44SGD	1	Silver Frame Glass Doors	17 x ¾ x 15¾
PL170†	1	Bridge	47 x 24 x 29½
PL142†	1	Credenza Half Leg	12¾ x 1 x 28
PLTHAT5172†	1	Laminate Desk Casings	72 x 30 x 27¼-51
PLTAP1554S	1	Frosted Acrylic Shield	54 x ¼ x 15
OSTB400	2	Desk Mount Shield Bracket	

Height Adjustable Typical  
**OS174†**  
 Total List: \$7,761.00  
 72"W x 101"D x 65½"H  
 Excludes Seating & Accessories  
 Pictured w/Provident Seating



Note: American Elm **only** available for select SKUs.  
 Select SKUs are notated by a † mark at the end of their SKU.





STANDUP STANDING DESKS

**NEW! U Shape Typical  
OSTYP319†**  
Total List: \$5,759.00  
72"W x 96"D  
Excludes Seating & Accessories  
Pictured w/Zella & Cade Seating



**NEW! OSTYP319** | Components

SKU #	QTY	DESCRIPTION	W x D x H
PLTECAB6078ECOWF	1	3-Stage Electric Corner Base	54-69 <sup>1</sup> / <sub>16</sub> " x 54-69 <sup>1</sup> / <sub>16</sub> " x 24 <sup>1</sup> / <sub>8</sub> "-50
PLT2472†	1	Rectangular Top	72 x 24 x 1
PLT2448†	1	Rectangular Top	48 x 24 x 1
PL143†	1	Credenza Shell	71 x 24 x 29 <sup>1</sup> / <sub>2</sub>
PL114†	1	Combo Lateral File - B/B/F/Lat.	31 x 22 x 29 <sup>1</sup> / <sub>2</sub>

Metal Base Finishes



BK Black  
(Select SKUs)

SI Silver

Note: American Elm **only** available for select SKUs.  
Select SKUs are notated by a † mark at the end of their SKU.

**OS229** | Components

SKU #	QTY	DESCRIPTION	W x D x H
PL1012†	2	2 Drawer Personal Cabinet	35 <sup>1</sup> / <sub>2</sub> x 22 x 22
PL2013†	2	Open Shelf Cabinet	35 <sup>1</sup> / <sub>2</sub> x 22 x 22
PL110HAT	2	Optional Top	71 x 35 <sup>1</sup> / <sub>2</sub> x 1
PLT3072†	2	Rectangular Top	72 x 30 x 1
PLTEAB4872BUDECONF	2	3-Stage Electric Base	46 <sup>1</sup> / <sub>16</sub> -70 <sup>1</sup> / <sub>16</sub> " x 23 <sup>1</sup> / <sub>16</sub> "-29 <sup>1</sup> / <sub>16</sub> " x 27 <sup>3</sup> / <sub>16</sub> "-44 <sup>1</sup> / <sub>16</sub> "
PLTADAPTHATFOOT30	2	Single Adapter Foot w/Spacer	29 <sup>1</sup> / <sub>2</sub> x 3 <sup>3</sup> / <sub>16</sub> " x 2 <sup>1</sup> / <sub>16</sub> "
CUSH2136	2	Top Cushion	35 <sup>1</sup> / <sub>2</sub> x 22 x 1 <sup>1</sup> / <sub>2</sub>
OSF9500	2	Desk Mount Power Module	

**Height Adjustable Typical  
OS229**

Total List: \$11,394.00  
145"W x 70<sup>3</sup>/<sub>4</sub>"D x 25<sup>1</sup>/<sub>2</sub>-51"H  
Excludes Accessories

OS229 available in CG Coastal Gray, ES Espresso & MW Modern Walnut Only.

Note: PL109HAT & PL110HAT is available in ES Espresso, MW Modern Walnut & CG Coastal Gray Only.



## OS LAMINATE RECEPTION

*Pictured w/Palma & Partridge Seating*

**Reception Typical  
OS153†**  
Total List: \$2,919.00  
71"W x 72"D x 41½"H  
*Excludes Seating & Accessories*



**NEWI AE American Elm**  
(†Select SKUs)

**CG Coastal Gray**

**ES Espresso**

**MW Modern Walnut**

**MH Mahogany**

**CH Cherry**

**WH White**

**MA Maple**

### A Reception Desk Shell PL169NTT†

71"W x 30"D x 40½"H  
List: \$915.00

*Note: Reception desk shells do not require transaction tops.*

### B Optional Reversible Return PL180†

42"W x 24"D x 40½"H  
List: \$571.00

### C Optional Curved Glass Transaction Top PL169TTGLASS

71"W x 17¾"D  
List: \$737.00

*Available in FR Frosted Glass  
w/Metal Risers Included*

### D Optional Metal Risers (Included w/PL169TTGLASS)

**PL169RISER**  
List: \$119.00

*Available in BA  
Brushed Aluminum*



*Pictured w/OS232 Typical*

### E Optional Curved Laminate Transaction Top PL169TT†

71"W x 17¾"D  
List: \$198.00

*Note: American Elm only available for select SKUs. Select SKUs are notated by a † mark at the end of their SKU.*

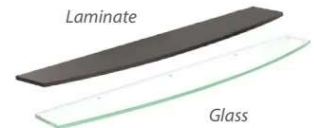

## ADDITIONAL PRODUCTS



### Reversible Reception Overlay

*(For PL169NTT)*

**PL169DELTT**

59"W x 11¾"D x 27¼"H  
List: \$812.00



*Hangs Over  
Existing Gables*



## RISER FEATURES

*Metal risers help to elevate  
laminated and glass transaction  
tops for a floating, sleek look*



*Note: When purchasing an  
optional transaction top, metal  
counter risers are not required.*



**WH White**



## OS LAMINATE RECEPTION



### Reception Typical OS36

Total List: \$3,795.00  
72"W x 72"D x 42"H  
Excludes Accessories  
Transaction Top in CG & ES Only

#### OS36 | Components

SKU #	QTY	DESCRIPTION	W x D x H
PL181R†	1	Credenza w/Corner Ext. - Rt	66 x 24/36 x 29½
PL179†	1	Reversible Return	30 x 24 x 29½
PL166†	1	Deluxe Full Pedestal - B/B/F	15½ x 22 x 28½
PBTC66L	1	Corner Transaction Top - Left	66 x 12 x 1
PBTC66R	1	Corner Transaction Top - Right	66 x 12 x 1
PBP12	3	Posts	1¾ x 1¾ x 12
PB21266ACR	2	Acrylic Panel	66 x ¾ x 12

OS36 available in ES Espresso & CG Coastal Gray Only.



### Reception Typical OS232†

Total List: \$2,380.00  
71"W x 78"D x 41½"H  
Excludes Seating & Accessories  
Pictured w/Integrate Seating

#### OS232 | Components

SKU #	QTY	DESCRIPTION	W x D x H
PL169NTT†	1	Reception Desk Shell	71 x 30 x 40½
PL180†	1	Reception Return Shell	42 x 24 x 40½
PL169TT†	1	Transaction Top	71 x 17¾ x 1
PL166†	1	Deluxe Full Pedestal - B/B/F	15½ x 22 x 28½



### Reception Typical OS77†

Total List: \$2,234.00  
71"W x 35½"D x 42½"H  
Excludes Seating & Accessories  
Pictured w/CoolMesh Seating &  
Optional Tempered Glass Chair Mat

#### OS77 | Components

SKU #	QTY	DESCRIPTION	W x D x H
PL169NTT†	1	Reception Desk Shell	71 x 30 x 40½
PL169TT†	1	Transaction Top	71 x 19¾ x 1
PL169RISER	1	Metal Counter Riser	¾ Dia x 1
PL107†	2	Hanging 3/4 Pedestal - B/F	15½ x 22 x 19

Note: American Elm **only** available for select SKUs. Select SKUs are notated by a † mark at the end of their SKU.



## PALISADES - RECEPTION

**A Reception Desk (Desk Only)**  
**EVRC1L (Left)**  
**EVRC1R (Right)**  
 87½"W x 37"D x 47½"H  
 List: \$4,939.00

**B Optional Reversible Return**  
**EVRC2**  
 47½"W x 23¾"D x 41¼"H  
 List: \$950.00

Tempered Glass  
 Transaction Top



EVRC1R - User Side



EVRC1L - Profile Side



Optional Reversible Return

### FEATURES

- Laminate is water, scratch, stain, fade & mildew resistant
- Sharp, contemporary design with a smoky Gauntlet Gray laminate finish for a sleek, modern look
- Base frame is made from durable metal with a graphite finish
- Boasts a ½" thick, tempered glass transaction top over graphite metal standoffs
- Pedestals house an optional power module that seamlessly integrates with two standard outlets and two USB outlets



### PRODUCT FEATURES

Laminate tops have a 1.65" thick  
 PVC edge and floating look

Modern graphite pulls complement  
 the frame finish completely



GG Gauntlet Gray  
 w/Graphite Metal





**COSMO - RECEPTION**

**Reception Typical  
COSMO1**  
Total List: \$14,862.00  
189"W x 63"D x 41"H  
Includes: RCN3131C (2),  
RCN6331 (2) & RCN32ADA (2)  
*Excludes Seating & Accessories*

**A 63"W Reception Desk  
w/Straight Glass Counter  
RCN6331**  
63"W x 31"D x 41"H  
List: \$3,289.00

**B 47"W Reception Desk  
w/Straight Glass Counter  
RCN4731**  
47"W x 31"D x 41"H  
List: \$3,033.00

**C Curved Reception Corner  
w/Curved Glass Counter  
RCN3131C**  
31½"W x 31½"D x 41"H  
List: \$3,157.00

**D 32"W Reversible ADA Return  
RCN32ADA**  
31½"W x 31½"D x 29½"H  
List: \$985.00

**FEATURES**

- Top panel is a 25mm thick MDF board with edge banding
- 8mm Tempered glass counter tops
- Laminate work surface resists scratches, stains & spills
- Two grommets per work station



CB Cordova Brown      SG Steely Gray

Some items in this collection come ready-to-assemble.



**Reception Typical  
COSMO2**  
Total List: \$15,413.00  
111"W x 79½"D x 41"H  
*Excludes Seating & Accessories*

**COSMO2 | Components**

SKU #	QTY	DESCRIPTION	W x D x H
RCN4731	3	47" Reception Desk	47 x 31 x 41
RCN3131C	2	Curved Reception Corner	31½ x 31½ x 41



**Reception Typical  
COSMO3**

Total List: \$23,359.00  
 111"W x 31½"D x 41"H (Front Reception)  
 157½"W x 22"D x 68½"H (Back Wall)  
 Includes: RCN4731, RCN3131C (2), RCN3222BC  
 (2), RCN3222STG (3), RCN3222LAT (2) &  
 RCN3222WB (2)  
 Excludes Seating & Accessories

**COSMO**

**E Bookcase Hutch**  
 RCN3222BC  
 31½"W x 22"D x 39"H  
 List: \$1,546.00

**F Storage Cabinet**  
 RCN3222STG  
 31½"W x 22"D x 29½"H  
 List: \$1,268.00

**G 2 Drawer Lateral File**  
 RCN3222LAT  
 31½"W x 22"D x 29½"H  
 List: \$1,963.00

**H Wardrobe & Bookcase Hutch**  
 RCN3222WB  
 31½"W x 22"D x 39"H  
 List: \$1,595.00

**ADDITIONAL PRODUCTS**



See Page 224 for full collection of  
 laminate pedestals

Casters hidden  
 behind laminate

**Mobile Pedestal  
 Box/Box/File  
 PL148†**  
 16"W x 22½"D x 28½"H  
 List: \$946.00

Note: PL148 is only available in NEW! AE  
 American Elm, CH Cherry, ES Espresso, MH  
 Mahogany, MA Maple, MW Modern Walnut,  
 CG Coastal Gray & WH White.

Espresso finish complements the Cordova Brown  
 Coastal Gray finish complements the Steely Gray



CB Cordova Brown SG Steely Gray

**Reception Typical  
 COSMO4**

Total List: \$7,431.00  
 94½"W x 63"D x 41"H  
 Includes: RCN6331, RCN3131C & RCN32ADA  
 Excludes Accessories



Some items in this collection come ready-to-assemble.





**Reception Typical**

**COSM05**

Total List: \$13,877.00

126"W x 94½"D x 41"H

*Excludes Seating & Accessories*

**COSM05 | Components**

SKU #	QTY	DESCRIPTION	W x D x H
RCN6331	2	63" Reception Desk	63 x 31 x 41
RCN3131C	2	Curved Reception Corner	31½ x 31½ x 41
RCN32ADA	1	Reversible ADA Return	31½ x 31½ x 29½



**Reception Typical**

**COSM06**

Total List: \$7,175.00

79½"W x 63"D x 41"H

*Excludes Seating & Accessories*

**COSM06 | Components**

SKU #	QTY	DESCRIPTION	W x D x H
RCN4731	1	47" Reception Desk	47 x 31 x 41
RCN3131C	1	Curved Reception Corner	31½ x 31½ x 41
RCN32ADA	1	Reversible ADA Return	31½ x 31½ x 29½



**Reception Typical**

**COSM07**

Total List: \$15,669.00

126"W x 79½"D x 41"H

*Excludes Seating & Accessories*

**COSM07 | Components**

SKU #	QTY	DESCRIPTION	W x D x H
RCN4731	2	47" Reception Desk	47 x 31 x 41
RCN3131C	2	Curved Reception Corner	31½ x 31½ x 41
RCN6331	1	63" Reception Desk	63 x 31 x 41



*Design Your Own  
with OfficeSource®*

## BORDERS II

### Configure Your Way!

**Configurable** – Keep it simple with an individual reception desk or combine components to create multi-user desks with panels.

- **Mix & Match** - 24"H Panels can be combined with 12"H panels to make 36"H panels; 12"H panels can be combined by 2's or 3's to create 24"H or 36"H panels
- **Clear Acrylic Panels** - 12"H, 24"H & 36"H; Also 24" & 36"H panels with transaction space.

**Privacy Features** – Upgrade to whiteboard or fabric tack board panels on divider walls to create more work space off the table top.

**Additional Space Options** – Add transaction tops to the privacy panel for additional functionality and workspace.

**Storage** – Customize filing options to maximize your space.

**\*Stylish** – Choose from 8 rich woodgrain laminate finishes in stock.

**Quality Materials** – GreenGuard certification means low-emission materials for a healthier office.

*\*Note: NEW! AE American Elm finish available only for Select SKUs marked with †.*



#### Solid Fabric Panels



GR Cool Gray

VS Visconti

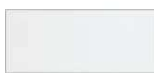

Acrylic or  
White Board

#### Transaction Top Finishes



CG Coastal Gray

ES Espresso

#### Frames & Posts



SI Silver



## BORDERS II



(Frosted)



### Frosted Acrylic Panels - 12"H

PB21224ACR	24"W x 12"H	\$148.00
PB21230ACR	30"W x 12"H	\$178.00
PB21236ACR	36"W x 12"H	\$221.00
PB21242ACR	42"W x 12"H	\$258.00
PB21248ACR	48"W x 12"H	\$297.00
PB21260ACR	60"W x 12"H	\$354.00
PB21266ACR	66"W x 12"H	\$377.00
PB21271ACR	71"W x 12"H	\$414.00

### Fabric Panels - 12"H

PB21224	24"W x 12"H	\$148.00
PB21230	30"W x 12"H	\$162.00
PB21236	36"W x 12"H	\$191.00
PB21248	48"W x 12"H	\$264.00
PB21260	60"W x 12"H	\$324.00
PB21266	66"W x 12"H	\$354.00
PB21271	71"W x 12"H	\$398.00

Note: When ordering panels above, please indicate upholstery option.

### White Board Panels - 12"H

PB21230MWB	30"W x 12"H	\$237.00
PB21236MWB	36"W x 12"H	\$251.00

Available In WH White

### Optional Clear Acrylic Filler - 1/4" Thick

QSACRFILLER24	For 24"H Posts	\$267.00
QSACRFILLER36	For 36"H Posts	\$267.00

Available In SI Silver



(Clear)



(Clear)



(Clear)

### Clear Acrylic Panels - 12"H

QSCAB21224	24"W x 12"H	\$374.00
QSCAB21230	30"W x 12"H	\$453.00
QSCAB21236	36"W x 12"H	\$556.00
QSCAB21248	48"W x 12"H	\$688.00
QSCAB21260	60"W x 12"H	\$951.00
QSCAB21266	66"W x 12"H	\$1,013.00
QSCAB21272	71"W x 12"H	\$1,136.00

### Clear Acrylic Panels - 24"H

QSCAB2424	24"W x 24"H	\$439.00
QSCAB2430	30"W x 24"H	\$526.00
QSCAB2436	36"W x 24"H	\$637.00
QSCAB2442	42"W x 24"H	\$718.00
QSCAB2448	48"W x 24"H	\$859.00
QSCAB2460	60"W x 24"H	\$1,097.00
QSCAB2466	66"W x 24"H	\$1,286.00
QSCAB2472	71"W x 24"H	\$1,449.00

### Clear Acrylic Panels - 36"H

QSCAB3624	24"W x 36"H	\$439.00
QSCAB3630	30"W x 36"H	\$526.00
QSCAB3636	36"W x 36"H	\$637.00
QSCAB3642	42"W x 36"H	\$754.00
QSCAB3648	48"W x 36"H	\$887.00
QSCAB3660	60"W x 36"H	\$1,097.00



### Rectangular Transaction Top

PBTR30	30"W x 12"D	\$201.00
PBTR36	36"W x 12"D	\$251.00
PBTR48	48"W x 12"D	\$265.00
PBTR60	60"W x 12"D	\$295.00
PBTR66	66"W x 12"D	\$311.00
PBTR71	71"W x 12"D	\$326.00

Available In CG Coastal Gray & ES Espresso



### Corner Transaction Top

PBTC30L (Left)	30"W x 12"D	\$222.00
PBTC30R (Right)	30"W x 12"D	\$222.00
PBTC36L (Left)	36"W x 12"D	\$265.00
PBTC36R (Right)	36"W x 12"D	\$265.00
PBTC66L (Left)	66"W x 12"D	\$326.00
PBTC66R (Right)	66"W x 12"D	\$326.00
PBTC71L (Left)	71"W x 12"D	\$341.00
PBTC71R (Right)	71"W x 12"D	\$341.00

Available In CG Coastal Gray & ES Espresso

### Transaction Top Finishes



CG Coastal Gray



ES Espresso

QS = QUICKSHIP

### REQUIRED SUPPORTS

#### Panel Posts

PBP12	12" Post	\$163.00
PBP24	24" Post	\$251.00
PBP36	36" Post	\$417.00

Note: 24"H Panels can be stacked on top of 12" panels to create 36"H panels. 12"H panels can be stacked 2 or 3 inches high.

Available In SI Silver



### OPTIONAL BRACKETS

Used for temporary mounting of panels on work surfaces. Also, works for non-OS Laminated application.

#### Offset Clamp Mount (Set of 2)

PBPOCLMPPR \$65.00 ea.

#### Post Plate Mount

PBPPLATE \$28.00 ea.

Available In SI Silver



### Frames & Posts



SI Silver

# BORDERS II

## Clear Acrylic Panels w/Transaction Spacing

(For Use With 24"H Posts - 1/4" Thick)

QSCABTS2424	24"W x 24"H	\$439.00
QSCABTS2430	30"W x 24"H	\$526.00
QSCABTS2436	36"W x 24"H	\$637.00
QSCABTS2442	42"W x 24"H	\$718.00
QSCABTS2448	48"W x 24"H	\$858.00
QSCABTS2460	60"W x 24"H	\$1,097.00

## Clear Acrylic Panels w/Transaction Spacing

(For Use With 36"H Posts - 1/4" Thick)

QSCABTS3624	24"W x 36"H	\$439.00
QSCABTS3630	30"W x 36"H	\$525.00
QSCABTS3636	36"W x 36"H	\$638.00
QSCABTS3642	42"W x 36"H	\$718.00
QSCABTS3648	48"W x 36"H	\$859.00
QSCABTS3660	60"W x 36"H	\$1,189.00

Note: The transaction spacing is 3"H from the top of the table in order to be able to slide papers through underneath the bottom of the screen. Posts sold separately.



Clear Acrylic Panel w/Transaction Spacing



Optional Clear Acrylic Filler

## Optional Clear Acrylic Filler - 1/4" Thick

QSACRFILLER24	For 24"H Posts	\$267.00
QSACRFILLER36	For 36"H Posts	\$267.00

Available In SI Silver

## REQUIRED SUPPORTS

### Panel Posts

PBP12	12" Post	\$163.00
PBP24	24" Post	\$251.00
PBP36	36" Post	\$417.00

Note: 24"H Panels can be stacked on top of 12"H panels to create 36"H panels. 12"H panels can be stacked 2 or 3 inches high.

Available In SI Silver



## OPTIONAL BRACKETS

Used for temporary mounting of panels on work surfaces. Also, works for non-OS Laminate application.

### Offset Clamp Mount (Set of 2)

PBPOCLMPPR \$65.00 ea.

### Post Plate Mount

PBPPLATE \$28.00 ea.

Available In SI Silver



## Mounting Brackets

Purchase these optional mounting brackets for temporary or mobile applications. Easily attach them to your work surface top



Typical Available In CH Cherry, MH Mahogany, ES Espresso, MA Maple, MW Modern Walnut, CG Coastal Gray, WH White & NEW! AE American Elm.

## QSOSB27 | Components

SKU #	QTY	DESCRIPTION	W x D x H
PL103†	1	Desk Shell	60 x 30 x 29½
PL145†	1	Reversible Return	47 x 24 x 29½
PL107†	1	Hanging 3/4 Pedestal - B/F	15½ x 22 x 19
PBP24	6	Posts	1¼ x 1¼ x 24
QSCABTS2460	1	Clear Acrylic w/Transaction Space	60 x 1¼ x 24
QSCABTS2430	2	Clear Acrylic w/Transaction Space	30 x 1¼ x 24
QSCABTS2448	1	Clear Acrylic w/Transaction Space	48 x 1¼ x 24
PBPOCLMPPR	1	Offset Clamp Mount (Set of 2)	
PBPPLATE	6	Post Plate Mount	
QSACRFILLER24	1	Clear Acrylic Filler	2½ x 1¼ x 24

QS = QUICKSHIP

## L Shape Typical

QSOSB27†  
Total List: \$6,556.00  
60"W x 77"D x 54"H



GR Cool Gray

VS Visconti



Acrylic or White Board



CG Coastal Gray

ES Espresso



SI Silver

Note: American Elm only available for select SKUs. Select SKUs are notated by a † mark at the end of their SKU.





**BORDERS II**

**Multi-Person Typical  
OSB22†**  
Total List: \$17,659.00  
120"W x 60"D x 53½"H  
Excludes Seating & Accessories  
Pictured w/Tre Lite Seating



**QSOSB22 | Components**

SKU #	QTY	DESCRIPTION	W x D x H
CPSBF	4	Mobile Metal Pedestal	15 x 22 x 22¼
CUSH1522	4	Pedestal Top Cushion	15¼ x 22½ x 1½
PLTULEG60	3	Unite Leg Base	For (2) 30"D Tops
PLTCBBSINGLE	8	Connector Beam Bracket	
PLT3060†	4	Rectangular Top	60 x 30 x 1
PLTADJMDB4872	4	Adjustable Beam	67¾ x 2 x 1
PBP24	13	Posts	1¾ x 1¾ x 24
QSCABTS2430	6	Clear Acrylic w/Transaction Space	30 x ¼ x 24
QSCABTS2460	2	Clear Acrylic w/Transaction Space	60 x ¼ x 24
QSACRFILLER24	4	Clear Acrylic Filler	2½ x ¼ x 24

**QS = QUICKSHIP**

**Standard Pull Options**  
Customize Your Pull Options - See Page 35



**NEW! AE American Elm w/Silver Pulls**  
(†Select SKUs)

**CG Coastal Gray w/Silver Pulls**

**ES Espresso w/Silver Pulls**



**MW Modern Walnut w/Silver Pulls**

**MH Mahogany w/Black Pulls**

**CH Cherry w/Black Pulls**



**WH White w/Silver Pulls**

**MA Maple w/Black Pulls**

Note: American Elm **only** available for select SKUs. Select SKUs are notated by a † mark at the end of their SKU.

**OSB21 | Components**

SKU #	QTY	DESCRIPTION	W x D x H
PL105†	1	Desk Shell	71 x 30 x 29½
PL145†	1	Reversible Return	47 x 24 x 29½
PL166†	1	Deluxe Full Pedestal - B/B/F	15½ x 22 x 28½
PBTR71	1	Rectangular Transaction Top	71 x 12 x 1
PBP12	8	Posts	1¾ x 1¾ x 12
PB21236ACR	2	Acrylic Panels	36 x ¾ x 12
PB21230ACR	2	Acrylic Panels	30 x ¾ x 12
PB21248ACR	1	Acrylic Panel	48 x ¾ x 12
PLTFB	2	Flat Bracket	

OSB21 available in ES Espresso & CG Coastal Gray Only.

**Reception Typical  
OSB21**

Total List: \$4,704.00  
71"W x 83"D x 42"H  
Excludes Seating & Accessories  
Pictured w/Crusader Seating  
Transaction Top Only In CG or ES



## BORDERS II

### Reception Typical OSB16

Total List: \$6,296.00  
83"W x 89"D x 42"H  
Excludes Seating & Accessories  
Pictured w/CoolMesh Seating  
Transaction Top Only In CG or ES



## OSB20 | Components

SKU #	QTY	DESCRIPTION	W x D x H
PL105†	1	Desk Shell	71 x 30 x 29½
PL145†	1	Reversible Return	47 x 24 x 29½
PL166†	1	Deluxe Full Pedestal - B/B/F	15½ x 22 x 28½
PBTC30R	1	Corner Transaction Top (Right)	30 x 12 x 1
PBTR48	1	Rectangular Transaction Top	48 x 12 x 1
PBTC71L	1	Corner Transaction Top (Left)	71 x 12 x 1
PBP12	6	Posts	1¾ x 1¾ x 12
PB21271	1	Fabric Panel	71 x ¾ x 12
PB21230	2	Fabric Panels	30 x ¾ x 12
PB21248	1	Fabric Panel	48 x ¾ x 12

OSB20 available in ES Espresso & CG Coastal Gray Only.

### Reception Typical OSB20

Total List: \$4,715.00  
77"W x 83½"D x 42½"H  
Excludes Seating & Accessories  
Pictured w/CoolMesh Seating  
Transaction Top Only In CG or ES

## OSB16 | Components

SKU #	QTY	DESCRIPTION	W x D x H
PL145†	2	Reversible Return	47 x 24 x 29½
PL163	1	Corner Desk Shell	36 x 36 x 29½
PL166†	1	Deluxe Full Pedestal - B/B/F	15½ x 22 x 28½
PL175†	1	Deluxe Pedestal Full - F/F	15½ x 22 x 28½
PBP12	8	Posts	1¾ x 1¾ x 12
PB21224ACR	1	Acrylic Panel	24 x ¾ x 12
PB21236ACR	2	Acrylic Panels	36 x ¾ x 12
PB21248ACR	2	Acrylic Panels	48 x ¾ x 12
PBTR36	1	Rectangular Transaction Top	36 x 12 x 1
PBTR48	1	Rectangular Transaction Top	48 x 12 x 1

OSB16 available in ES Espresso & CG Coastal Gray Only.

### Standard Pull Options

Customize Your Pull Options - See Page 35



NEW! AE American  
Elm w/Silver Pulls  
(†Select SKUs)

CG Coastal Gray  
w/Silver Pulls

ES Espresso  
w/Silver Pulls



MW Modern Walnut  
w/Silver Pulls

MH Mahogany  
w/Black Pulls

CH Cherry  
w/Black Pulls



WH White  
w/Silver Pulls

MA Maple  
w/Black Pulls

Note: American Elm **only** available for select SKUs. Select SKUs are noted by a † mark at the end of their SKU.





## BORDERS II

### Reception Typical OSB25

Total List: \$9,714.00  
114"W x 89"D x 42"H  
Excludes Seating & Accessories  
Pictured w/Tre Lite & Manhattan Seating  
Transaction Top Only In CG or ES



## OSB09 | Components

SKU #	QTY	DESCRIPTION	W x D x H
PB21236	3	Fabric Panels	36 x ¾ x 12
PB21236MWB	6	White Board Panels	36 x ¾ x 12
PBP12	6	Posts	1¾ x 1¾ x 12
PBP24	5	Posts	1¾ x 1¾ x 24
PL182R†	1	Credenza w/Corner Ext (Right)	71 x 24/36 x 29½
PL182L†	1	Credenza w/Corner Ext (Left)	71 x 24/36 x 29½
PL192†	2	Reversible Return	35 x 24 x 29½
PL166†	2	Deluxe Full Pedestal - B/B/F	15½ x 22 x 28½

### Multi-Person Typical OSB09†

Total List: \$8,176.00  
142"W x 71"D x 54"H  
Excludes Accessories

Typical Available In CH Cherry, MH Mahogany, ES Espresso, MA Maple, MW Modern Walnut, CG Coastal Gray, WH White & NEW! AE American Elm.

Note: American Elm only available for select SKUs. Select SKUs are noted by a † mark at the end of their SKU.

## OSB25 | Components

SKU #	QTY	DESCRIPTION	W x D x H
PL145†	2	Reversible Return	47 x 24 x 29½
PL163	2	Corner Desk Shell	36 x 36 x 29½
PL188	1	Bridge	30 x 24 x 29½
PL166†	1	Deluxe Full Pedestal - B/B/F	15½ x 22 x 28½
PL175†	1	Deluxe Pedestal Full - F/F	15½ x 22 x 28½
PBP12	12	Posts	1¾ x 1¾ x 12
PB21230	1	Fabric Panel	30 x ¾ x 12
PB21236	4	Fabric Panels	36 x ¾ x 12
PB21248	2	Fabric Panels	48 x ¾ x 12
PBTR48	2	Rectangular Transaction Top	48 x 12 x 1
PBTR30	1	Rectangular Transaction Top	30 x 12 x 1
PBTC36L	2	Corner Transaction Top - Left	36 x 12 x 1
PBTC36R	2	Corner Transaction Top - Right	36 x 12 x 1

OSB25 available in ES Espresso & CG Coastal Gray Only.





## BORDERS II

**NEW! Reception Typical**  
**QSOSTYP327†**  
 Total List: \$12,621.00  
 142"W x 71"D x 53½"H  
 Excludes Seating, Reception  
 Tables & Accessories  
 Pictured w/CoolMesh & Dover Seating



## OSB10 | Components

SKU #	QTY	DESCRIPTION	W x D x H
PB21236	9	Fabric Panels	36 x ¾ x 12
PB21236ACR	6	Acrylic Panels	36 x ¾ x 12
PBP12	2	Posts	1¾ x 1¾ x 12
PBP24	1	Post	1¾ x 1¾ x 24
PBP36	8	Posts	1¾ x 1¾ x 36
PBTR36	1	Rectangular Transaction Top	36 x 12 x 1
PL182R†	1	Credenza w/Corner Ext (Right)	71 x 24/36 x 29½
PL182L†	1	Credenza w/Corner Ext (Left)	71 x 24/36 x 29½
PL192†	2	Reversible Return	35 x 24 x 29½
PL166†	2	Deluxe Full Pedestal - B/B/F	15½ x 22 x 28½
PL160	2	Corner Bookcase	24 x 24 x 30

OSB10 available in ES Espresso & CG Coastal Gray Only.

## NEW! QSOSTYP327 | Components

SKU #	QTY	DESCRIPTION	W x D x H
PL182R†	1	Credenza w/Corner Ext (Right)	71 x 24/36 x 29½
PL182L†	1	Credenza w/Corner Ext (Left)	71 x 24/36 x 29½
PL192†	2	Reversible Return	35 x 24 x 29½
PL166†	2	Deluxe Full Pedestal - B/B/F	15½ x 22 x 28½
PBP24	10	Posts	1¾ x 1¾ x 24
QSCABTS2436	4	Clear Acrylic w/Transaction Space	36 x ¼ x 24
QSCABTS2472	2	Clear Acrylic w/Transaction Space	71 x ¼ x 24
QACRFILLER24	3	Clear Acrylic Filler	2½ x ¼ x 24

QS = QUICKSHIP

### Standard Pull Options

Customize Your Pull Options - See Page 35



**NEW! AE American**  
 Elm w/Silver Pulls  
 (†Select SKUs)

**CG Coastal Gray**  
 w/Silver Pulls

**ES Espresso**  
 w/Silver Pulls



**MW Modern Walnut**  
 w/Silver Pulls

**MH Mahogany**  
 w/Black Pulls

**CH Cherry**  
 w/Black Pulls



**WH White**  
 w/Silver Pulls

**MA Maple**  
 w/Black Pulls

## Multi-Person Typical OSB10

Total List: \$12,505.00  
 142"W x 95"D x 66"H  
 Excludes Keyboard System  
 & Accessories  
 Transaction Top Only In CG or ES

Note: American Elm **only** available for select SKUs. Select SKUs are notated by a † mark at the end of their SKU.



# SAFEGUARD BARRIER



# SAFEGUARD BARRIER

## STRAIGHT PRIVACY SHIELDS



### 15" Fabric Shields

- 1/2"D x 15"H (Desk Top Mountable)

PLTFP1524	24" Wide	\$183.00
PLTFP1530	30" Wide	\$183.00
PLTFP1536	36" Wide	\$196.00
PLTFP1548	48" Wide	\$255.00
PLTFP1554	54" Wide	\$285.00
PLTFP1566	66" Wide	\$323.00



BL Celestial Blue

GK Dark Gray

### 15" Frosted Acrylic Shields

- 1/4"D x 15"H (Desk Top & Under Desk Mountable)

PLTAP1524S	24" Wide	\$239.00
PLTAP1530S	30" Wide	\$239.00
PLTAP1536S	36" Wide	\$254.00
PLTAP1542S	42" Wide	\$290.00
PLTAP1548S	48" Wide	\$313.00
PLTAP1554S	54" Wide	\$341.00
PLTAP1566S	66" Wide	\$357.00

Available In FR Frosted Acrylic

Note: Frosted Acrylic Shields come with rounded corners & are 1/4" thick.

### 24" Frosted Acrylic Shields

- 1/4"D x 24"H (Desk Top Mountable)

PLTAP2424S	24" Wide	\$261.00
PLTAP2430S	30" Wide	\$288.00
PLTAP2436S	36" Wide	\$345.00
PLTAP2442S	42" Wide	\$408.00
PLTAP2448S	48" Wide	\$450.00
PLTAP2454S	54" Wide	\$470.00
PLTAP2466S	66" Wide	\$575.00

Available In FR Frosted Acrylic



Note: The transaction spacing for shields using the FLAT brackets is 5/8"H from the top of the table to be able to slide paper underneath.

Shield Brackets  
See Page 97

## CLEAR ACRYLIC SHIELDS

### 15" Clear Acrylic Shields

- 1/4"D x 15"H (Desk Top Mountable)

QSACRV1524C	24" Wide	\$196.00
QSACRV1530C	30" Wide	\$216.00
QSACRV1536C	36" Wide	\$259.00
QSACRV1542C	42" Wide	\$267.00
QSACRV1548C	48" Wide	\$299.00
QSACRV1554C	54" Wide	\$324.00
QSACRV1560C	60" Wide	\$345.00
QSACRV1566C	66" Wide	\$382.00
QSACRV1572C	72" Wide	\$397.00

### 24" Clear Acrylic Shields

- 1/4"D x 24"H (Desk Top Mountable)

QSACRV2424C	24" Wide	\$232.00
QSACRV2430C	30" Wide	\$267.00
QSACRV2436C	36" Wide	\$335.00
QSACRV2442C	42" Wide	\$359.00
QSACRV2448C	48" Wide	\$411.00
QSACRV2454C	54" Wide	\$472.00
QSACRV2460C	60" Wide	\$513.00
QSACRV2466C	66" Wide	\$564.00
QSACRV2472C	72" Wide	\$616.00

### 30" Clear Acrylic Shields

- 1/4"D x 30"H (Desk Top Mountable)

QSACRV3024C	24" Wide	\$282.00
QSACRV3030C	30" Wide	\$335.00
QSACRV3036C	36" Wide	\$411.00
QSACRV3042C	42" Wide	\$463.00
QSACRV3048C	48" Wide	\$513.00
QSACRV3054C	54" Wide	\$564.00
QSACRV3060C	60" Wide	\$642.00
QSACRV3066C	66" Wide	\$693.00
QSACRV3072C	72" Wide	\$745.00

**Cleaning Instructions:**  
Acrylic can be safely cleaned and disinfected with most non-abrasive cleaners such as:

- Disinfecting Wipes
- Disinfectant Sprays
- Some Multi-Surface Cleaners (Check Labels)
- Mild Soaps

Note: Clear Acrylic Shields come with square corners & are 1/4" thick.

Available In CL Clear Acrylic

QS = QUICKSHIP

## CLEAR ACRYLIC SHIELDS W/CUT-OUT

### 24" Clear Acrylic Shields

w/Optional Cut-Out - 1/4"D x 24"H

QSACRV2424CCO	24" Wide	\$319.00
QSACRV2430CCO	30" Wide	\$356.00
QSACRV2436CCO	36" Wide	\$422.00
QSACRV2442CCO	42" Wide	\$448.00
QSACRV2448CCO	48" Wide	\$498.00
QSACRV2454CCO	54" Wide	\$560.00
QSACRV2460CCO	60" Wide	\$601.00
QSACRV2466CCO	66" Wide	\$653.00
QSACRV2472CCO	72" Wide	\$704.00

### 30" Clear Acrylic Shields

w/Optional Cut-Out - 1/4"D x 30"H

QSACRV3024CCO	24" Wide	\$371.00
QSACRV3030CCO	30" Wide	\$422.00
QSACRV3036CCO	36" Wide	\$498.00
QSACRV3042CCO	42" Wide	\$549.00
QSACRV3048CCO	48" Wide	\$601.00
QSACRV3054CCO	54" Wide	\$653.00
QSACRV3060CCO	60" Wide	\$729.00
QSACRV3066CCO	66" Wide	\$780.00
QSACRV3072CCO	72" Wide	\$832.00

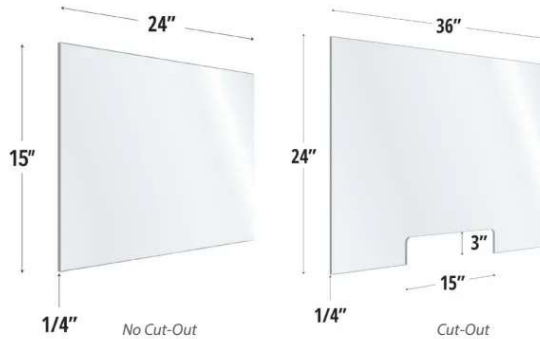

## TWO TIER SHIELD W/FOOT

Clear Acrylic/Laminate  
Two Tier Shield

LHI6153L

23 7/8"W x 60 1/4"D x 51 5/8"H

List: \$942.00



DB Distressed Brown



Pictured w/Tre Seating



# SAFEGUARD BARRIER

## SHIELD BRACKETS - FOR FABRIC & ACRYLIC PANELS

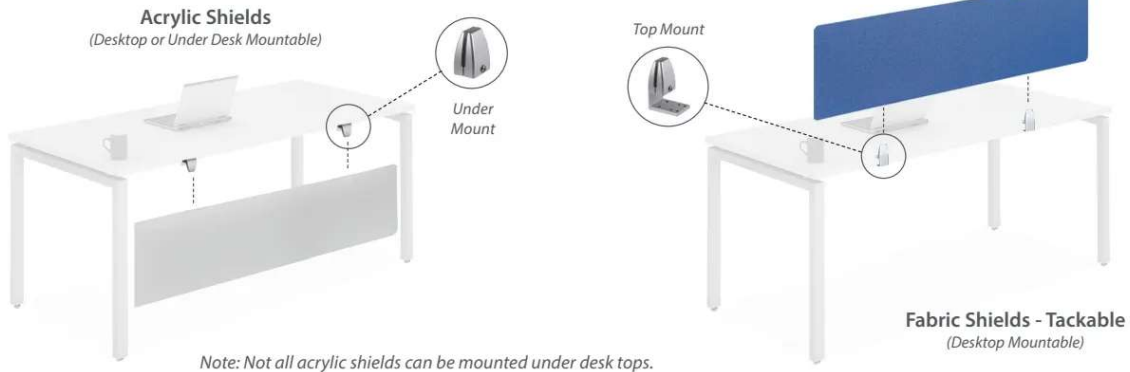

## FABRIC & ACRYLIC SHIELD BRACKETS



**Desk Mount Bracket**  
(Mounts to Desk Top)  
**OSTB400** (Silver Only)  
List: \$37.00 ea.



**Under Desk Mount Bracket**  
(Set of 2 - Mounts to 1" Work Surface)  
**PLTSBUDMSGL**  
List: \$94.00  
*Note: Requires work surface overhang.*



**Dual Under Desk Mount Bracket**  
(Set of 2 - Mounts Between Work Surfaces)  
**PLTSBUDMDUAL**  
List: \$128.00  
*Note: Requires work surface overhang.*

**BK Black**      **SI Silver**

Note: Fabric & Acrylic Brackets can be shipped by a small package carrier. 

## TEMPORARY SHIELD BRACKETS



**Work Surface Clamp Bracket**  
(For 1-1/2" Thick Tops)  
**OSCLMB**  
List: \$102.00 ea.

Note: These brackets include an anti-slip, textured bottom to prevent movement when mounted to desk top surface.

Note: Temporary Brackets can be shipped by a small package carrier. 



**Free-Standing Panel Foot**  
**OSFSPB**  
List: \$89.00 ea.



**SI Silver**

## SHIELD STABILIZER BRACKETS

*Acrylic Stabilizer Brackets can be used on the top or bottom of acrylic shields to connect multiple shields together for added stability.*



**Corner Bracket**  
**OSSL**  
List: \$56.00 ea.



**Straight Bracket**  
**OSSS**  
List: \$51.00 ea.



**X-Shaped Bracket**  
**OSSSX**  
List: \$70.00 ea.



**T-Shaped Bracket**  
**OSSST**  
List: \$66.00 ea.

**SI Silver**

Note: Stabilizer Brackets can be shipped by a small package carrier. 



## OS PANELS

## OS Panel Systems

### Panel Systems Detail

Explore the endless possibilities of configuring your office space through the use of office partitions, office dividers and panel systems. We do not align ourselves with one exclusive panel manufacturer, but distribute the products of several manufacturers, allowing our sales professionals to offer our customers more options at better pricing. View our gallery of office partitions to see how partitions and panels can transform your office into a functional, practical and stylish environment.



## PANELS

### A Upholstered Panels

SP4224	24"W x 42"H	\$407.00
SP4230	30"W x 42"H	\$436.00
SP4236	36"W x 42"H	\$491.00
SP6624	24"W x 66"H	\$492.00
SP6630	30"W x 66"H	\$549.00
SP6636	36"W x 66"H	\$593.00
SP6648	48"W x 66"H	\$725.00
SP6660	60"W x 66"H	\$844.00
SP6672	72"W x 66"H	\$999.00

### B Opaque View-Through Panels

SPG6624	24"W x 66"H	\$584.00
SPG6630	30"W x 66"H	\$640.00
SPG6636	36"W x 66"H	\$725.00

Note: Freestanding panels require end caps.

## FEATURES

- Easily create a functional & productive workspace with the use of office partitions
- Durable, pewter fabric upholstery with a 2 1/2" extruded aluminum external frame in a charcoal finish
- Panel systems include cubicle panels
- Ready-to-assemble

## ADDITIONAL ACCESSORIES

SP242	2 Way Corner connector 42"	\$107.00
SP266	2 Way Corner connector 66"	\$149.00
SP342	3 Way T connector 42"	\$137.00
SP366	3 Way T connector 66"	\$190.00
SP442	4 Way + connector 42"	\$142.00
SP466	4 Way + connector 66"	\$198.00
SPPG24	24" Filler For 42" to 66"	\$52.00
SPCAP24	End Cap 24"	\$38.00
SPCAP42	End Cap 42"	\$52.00
SPCAP66	End Cap 66"	\$65.00

Note: SPPG24 is a filler piece when using a 3-way connector & dropping from 66" to 42" panels.

SPBASE1	Support Foot	\$79.00
SPWM42	Wall Mount Kit 42"	\$101.00
SPWM66	Wall Mount Kit 66"	\$136.00
SPTB	Tie Bracket for Stabilizing Straight Run of Panels	\$14.00



Tie Bracket



Support Foot



Wall Mount Kit



End Cap 24"



PW Pewter Fabric w/CR Charcoal Frame

Note: All accessories on this page can be shipped by a small package carrier. 



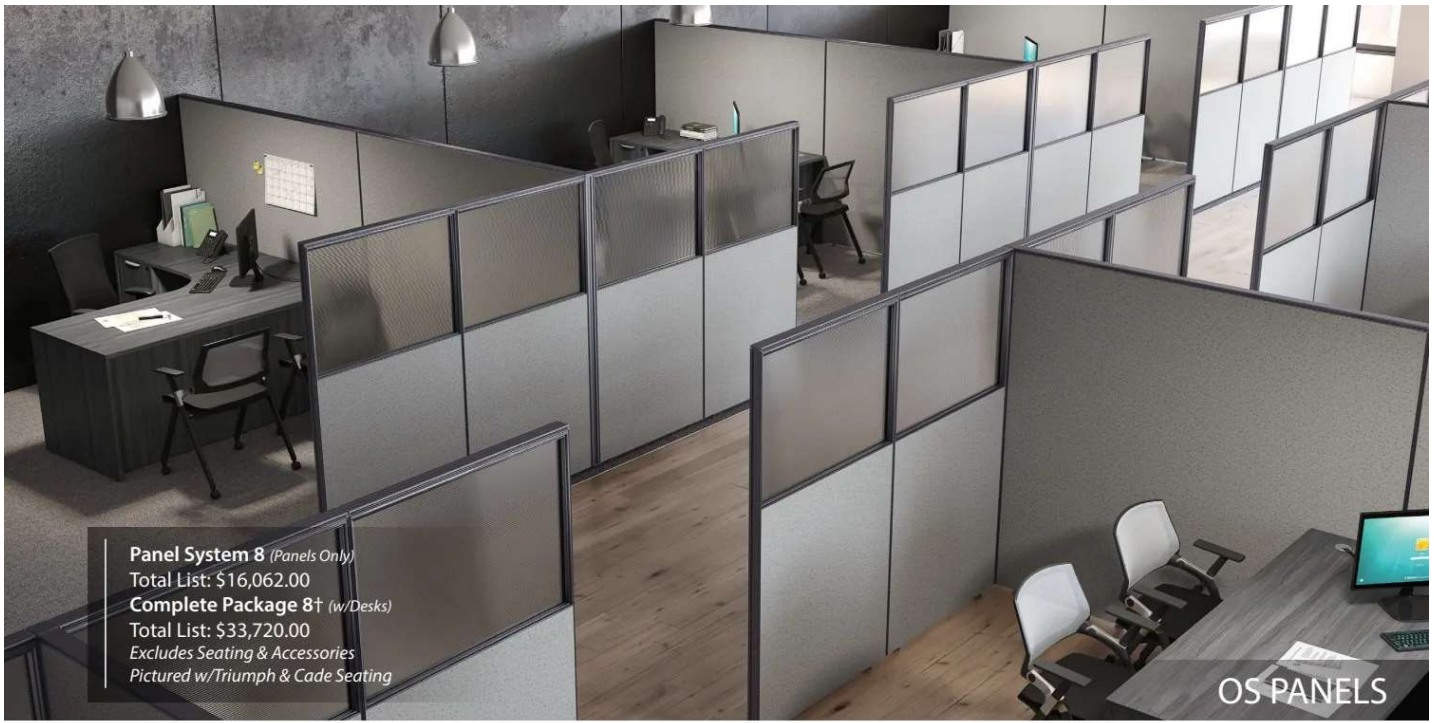

**Panel System 8 (Panels Only)**  
 Total List: \$16,062.00  
**Complete Package 8† (w/Desks)**  
 Total List: \$33,720.00  
 Excludes Seating & Accessories  
 Pictured w/Triumph & Cade Seating

**COMPLETE PACKAGE 8 | Components**

SKU #	QTY	DESCRIPTION	W x D x H
PL178L†	3	Desk w/Corner Extension - Lt	71 x 23½/42x 29½
PL178R†	3	Desk w/Corner Extension - Rt	71 x 23½/42x 29½
PL179†	6	Reversible Return	30 x 24 x 29½
PL166†	6	Deluxe Full Pedestal - B/B/F	15½ x 22 x 28½
PL175†	6	Deluxe Full Pedestal - F/F	15½ x 22 x 28½
SP366	3	3 Way T Connector	
SP6672	6	Upholstered Panels	72 x 2½ x 66
SPWM66	3	Wall Mount	
SPCAP66	6	End Cap 66"	
SPG6636	12	Opaque View-Through Panels	36 x 2½ x 66

Note: Panel System 8 lists left hand/top side of image only - double for complete room.

Note: American Elm only available for select SKUs.  
 Select SKUs are notated by a † mark at the end of their SKU.

**COMPLETE PACKAGE 1 | Components**

SKU #	QTY	DESCRIPTION	W x D x H
PL1012†	1	2 Drawer Personal Cabinet	35½ x 22 x 22
PL2013†	1	Open Shelf Cabinet	35½ x 22 x 22
PL110†	1	Credenza Top	71 x 22 x 1
PL1044OH†	1	Open Hutch	71 x 15 x 17
PL44LD†	1	Laminate Doors (Sets of 2)	17 x ¾ x 15¾
PLTLPHS20	1	Hutch Supports (Pair)	14 x 2 x 20
PLT2472†	2	Rectangular Top	72 x 24 x 1
PLTDR2430	1	Desk Riser	23¾ x 6½ x 2
PLTULEG24	3	Unite Leg	23¾ x 2 x 28½
PLTADJMDB4872	2	Adjustable Beam	67½ x 2 x 1
PLTCBBSINGLE	3	Connector Beam Bracket	
PL207†	1	Wardrobe Storage Unit	24¼ x 23¼ x 65½
SP6624	3	Upholstered Panels	24 x 2½ x 66
SP6672	1	Upholstered Panels	72 x 2½ x 66
SPG6636	4	Opaque View-Through Panels	36 x 2½ x 66
SP266	3	2 Way Corner Connector	
SPCAP66	2	End Cap 66"	



**Panel System 1 (Panels Only)**  
 Total List: \$5,952.00  
**Complete Package 1† (w/Desks)**  
 Total List: \$14,942.00  
 Excludes Accessories



PW Pewter Fabric  
 w/CR Charcoal Frame



**Panel System 6 (Panels Only)**  
 Total List: \$10,868.00  
**Complete Package 6† (w/Desks)**  
 Total List: \$41,668.00  
 Excludes Accessories

OS PANELS



**COMPLETE PACKAGE 6 | Components**

SKU #	QTY	DESCRIPTION	W x D x H
PLT3072†	4	Rectangular Top	72 x 30 x 1
PL1012†	4	2 Drawer Personal Cabinet	35½ x 22 x 22
PL2013†	4	Open Shelf Cabinet	35½ x 22 x 22
PL110†	4	Credenza Top	71 x 22 x 1
PL207†	4	Wardrobe Storage Unit	24¼ x 23¼ x 65½
SP6648	2	Upholstered Panels	48 x 2½ x 66
SP6636	2	Upholstered Panels	36 x 2½ x 66
SP4236	12	Upholstered Panels	36 x 2½ x 42
SPG6636	2	Opaque View-Through Panels	36 x 2½ x 66
SP366	2	3 Way T Connector	
SP466	1	4 Way T Connector	
SPCAP42	6	End Cap 42"	
PLTHATFEET30	4	Standard Feet (Set of 2)	23¾ x 3¾ x 1½
PLTEAB4872ECONF	4	3-Stage Electric Base	46¾-70¼ x 23¾-29½ x 24¾-50

Note: American Elm **only** available for select SKUs.  
 Select SKUs are notated by a † mark at the end of their SKU.

**COMPLETE PACKAGE 7 | Components**

SKU #	QTY	DESCRIPTION	W x D x H
PL183†	7	Three Drawer Lateral File	35½ x 22 x 42
PL109†	7	File/Credenza Top	35½ x 22 x 1
PL166†	4	Deluxe Full Pedestal - B/B/F	15½ x 22 x 28½
PLTULEG24	4	Unite Leg	23¾ x 2 x 28½
PLT2472†	4	Rectangular Top	72 x 24 x 1
PLTRETSSUPPORT	4	Return Bracket	
SP4224	4	Upholstered Panels	24 x 2½ x 42
SP4236	5	Upholstered Panels	36 x 2½ x 42
SP342	2	3 Way T Connector 42"	
SPCAP42	4	End Cap 42"	
PLTCBBSINGLE	4	Connector Beam Bracket	

**Panel System 7 (Panels Only)**  
 Total List: \$4,565.00  
**Complete Package 7† (w/Desks)**  
 Total List: \$33,306.00  
 Excludes Accessories



PW Pewter Fabric  
 w/CR Charcoal Frame

Note: PL109 is available in NEW! AE American Elm, ES Espresso, MW Modern Walnut, CG Coastal Gray & WH White Only.





OS PANELS

**Panel System 9** (Panels Only)  
 Total List: \$7,034.00  
**Complete Package 9†** (w/Desks)  
 Total List: \$10,898.00  
 Excludes Accessories



**COMPLETE PACKAGE 9** | Components

SKU #	QTY	DESCRIPTION	W x D x H
PL182R†	1	Credenza w/Corner Ext (Rt)	71 x 24/36 x 29½
PL182L†	1	Credenza w/Corner Ext (Lt)	71 x 24/36 x 29½
PL192†	2	Reversible Return	35 x 24 x 29½
PL166†	2	Deluxe Full Pedestal - B/B/F	15½ x 22 x 28½
SPG6636	6	Opaque View-Through Panels	36 x 2½ x 66
SP4236	4	Upholstered Panels	36 x 2½ x 42
SP266	2	2 Way Corner Connector 66"	
SP366	1	3 Way T Connector 66"	
SPCAP42	3	End Cap 42"	
SPCAP24	2	End Cap 24"	

Note: Panel System 9 is based on a 1 x 2 person pod.

Note: American Elm **only** available for select SKUs.  
 Select SKUs are notated by a † mark at the end of their SKU.

**COMPLETE PACKAGE 10** | Components

SKU #	QTY	DESCRIPTION	W x D x H
PL182R†	2	Credenza w/Corner Ext (Rt)	71 x 24/36 x 29½
PL182L†	2	Credenza w/Corner Ext (Lt)	71 x 24/36 x 29½
PL192†	4	Reversible Return	35 x 24 x 29½
PL166†	4	Deluxe Full Pedestal - B/B/F	15½ x 22 x 28½
SPG6636	8	Opaque View-Through Panels	36 x 2½ x 66
SP4236	8	Upholstered Panels	36 x 2½ x 42
SP366	2	3 Way T Connector 66"	
SP466	1	4 Way T Connector 66"	
SPCAP42	6	End Cap 42"	
SPCAP24	4	End Cap 24"	

**Panel System 10** (Panels Only)  
 Total List: \$10,770.00  
**Complete Package 10†** (w/Desks)  
 Total List: \$18,498.00  
 Excludes Accessories



PW Pewter Fabric  
 w/CR Charcoal Frame

# VIZUAL



**A Magnetic Steel Dry-Erase Board with Aluminum Frame**  
 – Magnetic, steel surface dry-erase boards with a professional aluminum frame that comes with a 4-Corner mounting system. These can be mounted vertically or horizontally. These boards feature a 10-Year Surface Warranty.



**B Magnetic Glass Dry-Erase Board**  
 – High-quality, magnetic glass dry-erase board surface made with tempered glass for safer use with a 4mm thickness and water resistant. These boards feature a Lifetime Limited Warranty.

A. Magnetic Steel Dry-Erase Board with Aluminum Frame				
OS05071MS	WH White	36"W x 48"H	7 lbs	\$405.00
OS21071MS	WH White	48"W x 96"H	19 lbs	\$1,057.00
OS27071MS	WH White	48"W x 72"H	14 lbs	\$795.00
B. Magnetic Glass Dry-Erase Board				
QSOSL0701MG	WH White	24"W x 36"H	14 lbs	\$414.00
OS0801MG	WH White	36"W x 48"H	29 lbs	\$767.00
OS1201MG	WH White	48"W x 72"H	57 lbs	\$1,603.00
OS2501MG	WH White	48"W x 96"H	93 lbs	\$2,233.00
C. Double-Sided Dry-Erase Mobile Revolving Easel with Silver Frame				
OSR5507MD	WH White	48"W x 72"H	86 lbs	\$3,989.00



**C Double-Sided Dry-Erase Mobile Revolving Easel**  
 – Magnetic, steel surface on both sides of the easel with a steel, tubular frame and support bars that makes it one of the most stable mobile easels in the marketplace. These boards feature a 10-Year Surface Warranty. Ready to Assemble.

**DRY-ERASE BOARD FEATURES**



*Porcelain boards come with a snap-on aluminum pen tray for easy accessory storage*



*Glass boards come with square corners with a pass-through mounting hardware*



*Magnets, pen tray and wall mounting hardware is all included with glass boards*

**MOBILE EASEL FEATURES**



*Pen and accessory tray can be repositioned easily for whatever is more comfortable and efficient for you*



*Adjustable, easel pad clips will virtually hold any size easel in place easily & an easel pad that stands at 80" x 24"D.*

Note: OSL0701MG, OS05071MS & OS0801MG on this page can be shipped by a small package carrier.

QS = QUICKSHIP



# NEW! VIZUAL



## Magnetic Glass Revolver & Mobile Easel

– Magnetic, high-quality glass surface that never ghosts, cleans easily, and is perfect for extensive use over time. The opaque white magnetic surface allows you to use the boards for posting or writing with a heavy-duty chrome stand and locking casters. Polished stainless steel pen tray is included. These boards feature a Lifetime Surface Warranty.

D. NEW! Magnetic Glass Mobile Easel with Chrome Frame				
QSOS4850MG	WH White	30"W x 42"H	79 lbs	\$5,000.00
E. NEW! Magnetic Glass Revolver with Chrome Frame				
QSOS0450MG	WH White	48"W x 60"H	133 lbs	\$6,700.00

Note: OS4850MG on this page can be shipped by a small package carrier. **QS = QUICKSHIP**

## FEATURES

- Surfaces are suitable for frequent and extensive use
- Ghost and scratch-resistant
- Porcelain and glass clean easily with very little maintenance involved with mild soap and warm water
- High-quality, durable surfaces and frames
- Lifetime Limited Warranty available on all boards



## MOBILE GLASS EASEL FEATURES



Magnetic surface doesn't stain or ghost with a tempered glass that is 4mm thick



Includes (2) extension arms for displaying easel pads that tuck away when not in use



Heavy-duty, 5-Star chrome base with locking casters & adjusts from 67"-75" tall

## GLASS REVOLVER FEATURES



Double-sided magnetic surface allows you to post notes or charts with a polished stainless steel pen tray included



Rounded corners with beveled edges and an opaque white glass that prevents show-through



Stunning, polished chrome frame with (4) locking casters that are suitable for extensive use all day



Pictured w/NEW! Oslo Armless Guest Seating & NEW! OSTYP320 Typical

## OS TRAINING TABLES

### Your Table, Your Way!

#### Build Your Custom Table...

Training Tables by OfficeSource® provide convenience and flexibility to any workstation, whether it be in a work environment or a classroom. These Training Tables by OfficeSource® feature 7 base options, several top sizes, and 8 finishes giving you the ability to configure them your way! Not only are these tables super customizable, but they also have such a simple yet sophisticated style to them that they can match any space.

### Configure Your Way!



Improved Folding Lever



Flip Top, Nesting

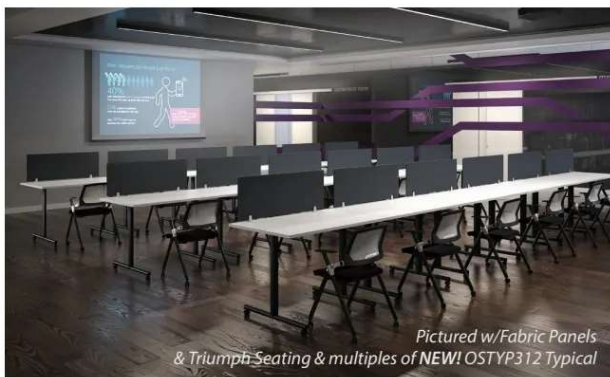

Pictured w/Fabric Panels & Triumph Seating & multiples of NEW! OSTYP312 Typical



Pictured w/Julep Seating & OST08 Typical

Eight Top Finishes | Several Top Sizes | Seven Base Options



# OS TRAINING TABLES

Custom Build Your Training Or Multi-Purpose Table By Combining Table Tops & Bases

## TRAINING TABLE BASES

Seven different options to choose from. See Page 106 for details.



**Flip Top Nesting**  
Base - Style 1  
(Modesty Panel Included)  
(Locking Casters Included)



**Flip Top Nesting**  
Base - Style 2  
(Locking Casters Included)



**Flip Top Nesting Adjustable Width**  
Base - Style 3  
(Locking & Leveling Capable Casters Included)



**"T" Leg Base w/Standard Glides**  
Base - Style 4



Nesting



Nesting



Nesting

### OPTIONAL CASTERS

(For T, Post & Unite Height Adj. Leg Bases)  
(See Page 106)



(Set of 2)



**Offset Square Leg Base**  
Base - Style 5



**Post Leg Base**  
Base - Style 6



**Unite Height Adjustable Leg Base**  
Base - Style 7

## RECTANGULAR TOP & SEVERAL SIZES

Rectangular top shape, several different sizes & eight top finishes to choose from. See Page 107 for details.



Rectangular Top  
(Compatible w/All Bases)



**NEW! American Elm Finish**  
(Shown in PLT2448)



Accessories  
(See Pages 106-107)



Ganging Hardware

### Laminate Top Finishes



**NEW! AE American Elm**  
(†Select SKUs)



CG Coastal Gray



ES Espresso



MW Modern Walnut



MH Mahogany



CH Cherry



WH White



MA Maple

Note: American Elm only available for select SKUs. Select SKUs are notated by a † mark at the end of their SKU.

### Metal Base Finishes



BK Black



SI Silver



WH White  
(Select SKUs)

# OS TRAINING TABLES



Available In BK Black & SI Silver



Available In BK Black, SI Silver & WH White



Available In BK Black & SI Silver



Available In BK Black & SI Silver

Optional Locking Casters Available for "T" Leg



OSTCCASTERS (Set of 2)



Available In BK Black & SI Silver



Available In BK Black & SI Silver

Posts Legs Available With Glides or Casters Included



Available In BK Black & SI Silver

Optional Locking Casters Available for Unite Adj. Leg



PLTULEGCASTERS (Set of 2)



Flip Top Nesting Base - Style 1 Includes Modesty Panel for Wire Management & Privacy

- A Flip Top, Nesting Base - Style 1**  
**PBF48** (For PLT2448 Tops) \$543.00 ea.  
**PBF60** (For PLT2460 Tops) \$614.00 ea.  
**PBF72** (For PLT2472 Tops) \$662.00 ea.

- B Flip Top, Nesting Base - Style 2**  
**PTLF60\*** (For 60"W Tops) \$821.00 ea.  
**PTLF72\*** (For 72"W Tops) \$869.00 ea.

- C Flip Top, Adj. Width Base - Style 3**  
**FTHAB4872** (48"-72"W - Adj.) \$796.00 ea.

- D "T" Leg Base - Style 4**  
**OSTLEG24** (For 24"D Tops) \$458.00 ctn.  
**OSTLEG30** (For 30"D Tops) \$492.00 ctn.  
 Note: "T" Leg Base Priced (2) Per Carton.

- E Offset Square Leg Base - Style 5**  
**PLTSQPOSTLEG** (For All Tops) \$253.00 ctn.  
 Note: Priced and sold as (2) per carton.

- F Post Leg Base - Style 6**  
**OSPOST28C** (With Casters) \$144.00 ctn.  
**OSPOST28G** (With Glides) \$142.00 ctn.  
 Note: Post Leg Base Priced (2) Per Carton.

- G Unite Adj. Height Leg Base - Style 7**  
**PLTULEG2485H** (For 24"D Tops) \$362.00 ea.

Note: Adj. Height Legs Require Brackets & Beams (See Page 119)

### Metal Base Finishes



BK Black

SI Silver

WH White (\*Select SKUs)

### OPTIONAL HARDWARE & ACCESSORIES

- 60" Stiffener Support** (For Tops 60" or larger)  
**PLT60MSBK\***  
 List: \$112.00 ctn.

- 72" Stiffener Support** (For Tops 72" or larger)  
**PLT72MSBK\***  
 List: \$140.00 ctn.

\*Note: Tops 60" Or Larger Require the Purchase of Stiffener Bars when using Base Styles 4, 5 & 6. (PLT60MS or PLT72MS - Stiffeners Come In Set of 2).

Note: PLT60MS & PLT72MS Priced (2) Per Carton.

- Flat Bracket**  
**PLTFBBK**  
 List: \$28.00 ea.



- Ganging Hardware**  
**PLTGCBK**  
 List: \$70.00 ea.



- Optional Casters**  
 (For "T" Leg Bases - Set of 2)

- OSTCCASTERSBK**  
 List: \$40.00 ea.

Note: Must order (1) Set Per Leg.

- Optional Casters**  
 (For Unite Adj. Leg Base - Set of 2)

- PLTULEGCASTERSBK**  
 List: \$65.00 ea.

Note: FTHAB4872, OSPOST28C, OSPOST28G, PLTFB, PLTGC, PLTULEGCASTERS & OSTCCASTERS can be shipped by a small package carrier.



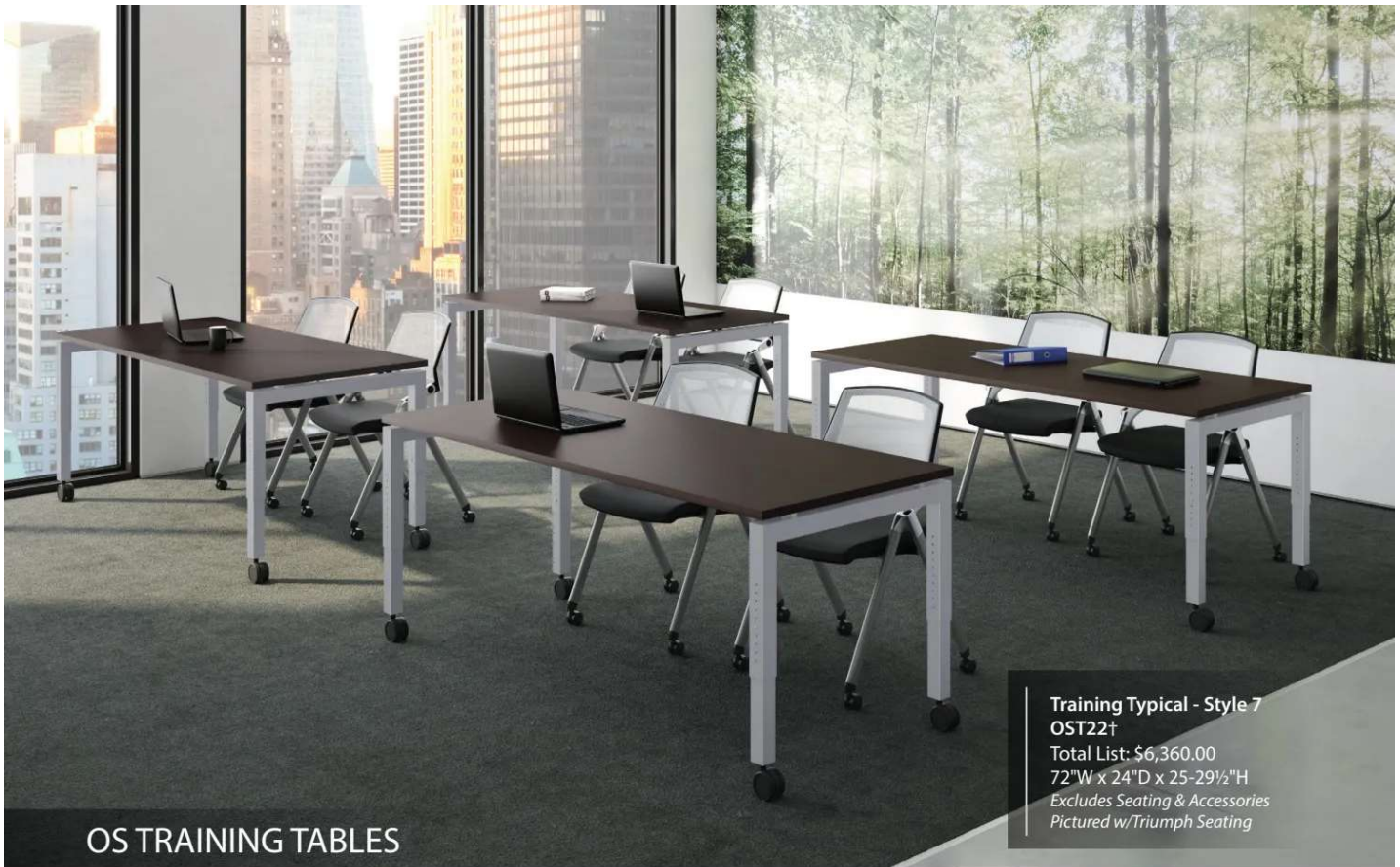

## OS TRAINING TABLES

**Training Typical - Style 7  
OST22†**  
Total List: \$6,360.00  
72"W x 24"D x 25-29½"H  
Excludes Seating & Accessories  
Pictured w/Triumph Seating

### OST22 | Components

SKU #	QTY	DESCRIPTION	W x D x H
PLT2472†	4	Rectangular Top	72 x 24 x 1
PLTULEG2485H	8	Unite Adj. Height Leg Base	63¼ x 20½ x 24-28½
PLTADJMDB4872	4	Adjustable Beam	67¾ x 2 x 1
PLTCBBSINGLE	8	Connector Beam Bracket	
PLTULEGCASTERS	8	Set of Casters - (Set of 2)	



Note: Adj. Height Legs Require Brackets & Beams. (See Page 119)



#### Rectangular Tops

PLT2448†	48"W x 24"D	\$360.00
PLT2460†	60"W x 24"D	\$405.00
PLT2466†	66"W x 24"D	\$443.00
PLT2472†	72"W x 24"D	\$443.00
PLT3048†	48"W x 30"D	\$393.00
PLT3060†	60"W x 30"D	\$487.00
PLT3066†	66"W x 30"D	\$519.00
PLT3072†	72"W x 30"D	\$519.00
PLT3672†	72"W x 36"D	\$628.00



### OPTIONAL MODESTY PANELS



#### Metal Perforated Modesty Panels - 15"H (18"H w/Included Brackets)

**MMP1853** (For 60"W Tops) \$183.00

**MMP1865** (For 72"W Tops) \$213.00

Available In SI Silver, BK Matte Black

Note: Metal Modesty Panels are for "T", Post, Unite Height Adjustable & Square Leg Bases.



#### Modesty Panel w/Trough - 10¼"H

**PTLFMOD60** (For 60"W Tops) \$149.00

**PTLFMOD72** (For 72"W Tops) \$162.00

Available In SI Silver, BK Matte Black

Note: For Flip Top nesting table bases (Style 2 & 3).



NEW! AE American Elm  
(†Select SKUs)



CG Coastal Gray



ES Espresso



MW Modern Walnut



MH Mahogany



CH Cherry



WH White



MA Maple

Note: American Elm only available for select SKUs. Select SKUs are noted by a † mark at the end of their SKU.



**OS TRAINING TABLES**

**Training Typical - Style 1  
OST13†**  
Total List: \$6,630.00  
144"W x 168"D x 29½"H  
Excludes Seating & Accessories  
Pictured w/Triumph Seating



*Pictured w/CoolMesh Pro Seating*

**OST13 | Components**

SKU #	QTY	DESCRIPTION	W x D x H
PLT2472†	6	Rectangular Top	72 x 24 x 1
PBF72	6	Flip Top, Nesting Base	63¼ x 20½ x 28½

**Training Typical - Style 1  
OST14†**  
Total List: \$6,114.00  
60"W x 24"D x 29½"H  
Excludes Seating & Accessories

**OST14 | Components**

SKU #	QTY	DESCRIPTION	W x D x H
PLT2460†	6	Rectangular Top	60 x 24 x 1
PBF60	6	Flip Top, Nesting Base	51¼ x 20½ x 28½

**Training Typical - Style 1  
OST03†**  
Total List: \$3,612.00  
48"W x 24"D x 29½"H  
Excludes Seating & Accessories

**OST03 | Components**

SKU #	QTY	DESCRIPTION	W x D x H
PLT2448†	4	Rectangular Top	48 x 24 x 1
PBF48	4	Flip Top, Nesting Base	37½ x 20½ x 28½



*Pictured w/Franklin Seating*

Note: American Elm only available for select SKUs. Select SKUs are notated by a † mark at the end of their SKU.





**OS TRAINING TABLES**

**NEW! Training Typical - Style 2  
OSTYP326†**  
Total List: \$6,540.00  
60"W x 30"D x 29½"H  
Excludes Seating & Accessories  
Pictured w/CoolMesh Pro Seating



*Pictured w/CoolMesh Pro Seating*

**NEW! OSTYP326 | Components**

SKU #	QTY	DESCRIPTION	W x D x H
PLT3060†	5	Rectangular Top	60 x 30 x 1
PTLF60	5	Flip Top, Nesting Base	45¾ x 23 x 28½

**Training Typical - Style 2  
OST27†**

Total List: \$13,750.00  
Single Unit: 60"W x 24"D x 29½"H  
Excludes Seating & Accessories

**OST27 | Components**

SKU #	QTY	DESCRIPTION	W x D x H
PLT2460†	10	Rectangular Top	60 x 24 x 1
PTLF60	10	Flip Top, Nesting Base	45¾ x 23 x 28½
PTLFMOD60	10	Modesty Panel	44¾ x 2¼ x 10¼



*Pictured w/NEW! Armless Oslo Guest Seating*

**NEW! Training Typical - Style 2  
OSTYP320†**

Total List: \$9,184.00  
216"W x 168"D x 29½"H  
Excludes Seating & Accessories

**NEW! OSTYP320 | Components**

SKU #	QTY	DESCRIPTION	W x D x H
PLT2472†	7	Rectangular Top	72 x 24 x 1
PTLF72	7	Flip Top, Nesting Base	58 x 23 x 28½

Note: American Elm *only* available for select SKUs. Select SKUs are notated by a † mark at the end of their SKU.





**OS TRAINING TABLES**

**Training Typical - Style 3  
OST26†**  
Total List: \$11,560.00  
48"W x 24"D x 31"H  
*Excludes Accessories*



*Pictured w/Franklin Seating*

**OST26 | Components**

SKU #	QTY	DESCRIPTION	W x D x H
PLT2448†	10	Rectangular Top	48 x 24 x 1
FTHAB4872	10	Flip Top, Nesting Adj. Width Base	45-68½ x 24-30 x 30

**Training Typical - Style 4  
OST20†**

Total List: \$11,318.00  
48"W x 30"D x 29½"H  
*Excludes Seating & Accessories*

**OST20 | Components**

SKU #	QTY	DESCRIPTION	W x D x H
PLT3060†	10	Rectangular Table Top	60 x 30 x 1
OSTLEG30	6	"T" Leg Base (Set of 2)	30 x 6 x 28½
PLTAP1530S	8	Frosted Acrylic Shield	30 x ¼ x 15
PLT60MS	5	Stiffener Support (Set of 2)	48 x 2¼ x 1
PLTSBUDMDUAL	8	Dual Mount Shield Bracket	(Set of 2)

**NEW! Training Typical - Style 4  
OSTYP312†**

Total List: \$1,922.00  
60"W x 24"D x 44½"H  
*Excludes Seating & Accessories*

**NEW! OSTYP312 | Components**

SKU #	QTY	DESCRIPTION	W x D x H
OSTLEG24	2	"T" Leg Base (Set of 2)	24 x 6 x 28½
PLT2460†	1	Rectangular Table Top	48 x 30 x 1
OSCLMBSI	2	Work Surface Clamp Bracket	
PLTFP1554	1	Fabric Shield	54 x ½ x 15
PLT60MS	1	Stiffener Support (Set of 2)	48 x 2¼ x 1



*Pictured w/Triumph Seating*

*Note: OSTYP312 is based on a single desk workstation set-up. For multiple desk units, please double the amount as needed.*

*Note: American Elm **only** available for select SKUs. Select SKUs are notated by a † mark at the end of their SKU.*





**OS TRAINING TABLES**

**Training Typical - Style 4  
OST19†**  
Total List: \$8,752.00  
48"W x 30"D x 29½"H  
Excludes Seating & Accessories  
Pictured w/Triumph Seating



*Pictured w/Julep Seating*

**OST19 | Components**

SKU #	QTY	DESCRIPTION	W x D x H
PLT3048†	8	Rectangular Table Top	48 x 30 x 1
OSTLEG30	8	™™ Leg Base (Set of 2)	30 x 6 x 28½
PLTAP1542S	4	Frosted Acrylic Shield	42 x ¼ x 15
PLTSBUDMDUAL	4	Desk Mount Shield Brackets	(Set of 2)

**Training Typical - Style 5  
OST08†**

Total List: \$4,196.00  
60"W x 30"D x 29½"H  
Excludes Seating & Accessories

**OST08 | Components**

SKU #	QTY	DESCRIPTION	W x D x H
PLT3060†	4	Rectangular Top	60 x 30 x 1
PLTSQPOSTLEG	8	Offset Square Legs Base	2 x 2 x 28½
PLT60MS	2	Stiffener Support (Set of 2)	48 x 2¼ x 1

**Training Typical - Style 6  
OST07†**

Total List: \$3,492.00  
72"W x 30"D x 29½"H  
Excludes Seating & Accessories

**OST07 | Components**

SKU #	QTY	DESCRIPTION	W x D x H
PLT3072†	4	Rectangular Top	72 x 30 x 1
OSPOST28G	8	Post Table Leg Base (Set of 2)	4-6" Dia x 28½
PLT72MS	2	Stiffener Support (Set of 2)	60¼ x 2¼ x 1



*Pictured w/CoolMesh Seating*

Note: American Elm only available for select SKUs. Select SKUs are notated by a † mark at the end of their SKU.



## OS CONFERENCE TABLES "Boat Shaped Tops"

**Conference Typical  
PLELP236†**  
Total List: \$2,418.00  
95"W x 28/44"D x 29½"H  
*Excludes Seating & Power Insert  
Pictured w/Bradley Seating*

### Boat Shaped Conference Table w/Slab Base

(\*Two Piece Tops w/Two Grommets)

<b>PL235†</b>	6' Table Length	72"W x 20/35"D x 29½"H	\$822.00
<b>PL236†</b>	8' Table Length	95"W x 28/44"D x 29½"H	\$1,456.00
<b>PL237†*</b>	10' Table Length	120"W x 32/47¼"D x 29½"H	\$2,309.00
<b>PL238†*</b>	12' Table Length	144"W x 32/47¼"D x 29½"H	\$3,151.00

### Boat Shaped Conference Table w/Elliptical Base

(\*Two Piece Tops w/Two Grommets)

<b>PLELP236†</b>	8' Table Length	95"W x 28/44"D x 29½"H	\$2,418.00
<b>PLELP237†*</b>	10' Table Length	120"W x 32/47¼"D x 29½"H	\$3,271.00
<b>PLELP238†*</b>	12' Table Length	144"W x 32/47¼"D x 29½"H	\$4,621.00

Note: Grommets standard on all conference tops. Espresso, Modern Walnut & Coastal Gray come standard with Silver Grommets. **NEW!** American Elm, Cherry, Mahogany & Maple come standard with Black Grommets.

Note: Elliptical Bases Only Available in **NEW!** American Elm, Espresso, Modern Walnut, & Coastal Gray and come standard with Silver Trim Legs.

Pictured (1) PLELP236 - 8'  
Boat Shaped Table w/Elliptical Base



### Mobile Lectern

**PL216**  
23¾"W x 23¾"D x 46"H  
List: \$946.00

Note: Available in CG Coastal Gray, ES Espresso & MH Mahogany Only.

### OPTIONAL POWER



### Power Insert PLTBPOWER

Cutout: 9½"W x 4½"D  
Overall: 10¾"W x 4¾"D  
List: \$874.00

Available In SI Silver & BK Black

Note: This product can be shipped by a small package carrier.

(See page 231 for details)



**NEW!** AE American Elm  
(†Select SKUs)

CG Coastal Gray

ES Espresso

MW Modern Walnut

MH Mahogany  
(Select SKUs)

CH Cherry  
(Select SKUs)

WH White  
(Select SKUs)

MA Maple  
(Select SKUs)

Note: American Elm **only** available for select SKUs. Select SKUs are notated by a † mark at the end of their SKU.





## OS CONFERENCE TABLES "Boat Shaped Expandable Tops"

Pictured w/Franklin, Integrate & Willow Seating

### Boat Shaped Conference Table w/Slab Base - 47¼"D x 29½"H (\*Two Piece Tops w/Two Grommets)

PL237†*	10' Length	\$2,309.00
PL238†*	12' Length	\$3,151.00
PLCB14†	14' Length	\$3,920.00
PLCB16†	16' Length	\$4,494.00
PLCB18†	18' Length	\$5,263.00
PLCB20†	20' Length	\$5,837.00
PLCB22†	22' Length	\$6,606.00
PLCB24†	24' Length	\$7,180.00
PLCB26†	26' Length	\$7,949.00
PLCB28†	28' Length	\$8,523.00
PLCB30†	30' Length	\$9,292.00

### Boat Shaped Conference Table w/Elliptical Base - 47¼"D x 29½"H (\*Two Piece Tops w/Two Grommets)

PLELP237†*	10' Length	\$3,271.00
PLELP238†*	12' Length	\$4,621.00
PLCBELP14†	14' Length	\$6,149.00
PLCBELP16†	16' Length	\$6,723.00
PLCBELP18†	18' Length	\$8,251.00
PLCBELP20†	20' Length	\$8,825.00
PLCBELP22†	22' Length	\$10,353.00
PLCBELP24†	24' Length	\$10,927.00
PLCBELP26†	26' Length	\$12,455.00
PLCBELP28†	28' Length	\$13,029.00
PLCBELP30†	30' Length	\$14,557.00

Note: Grommets standard on all conference tops. Espresso, Modern Walnut & Coastal Gray come standard with Silver Grommets. NEW! American Elm, Cherry, Mahogany & Maple come standard with Black Grommets.

Note: Elliptical Bases Only Available in NEW! American Elm, Espresso, Modern Walnut, & Coastal Gray and come standard with Silver Trim Legs.



Pictured (1) PLCB14 - 14'  
Boat Shaped Table w/Slab Base

### Sample of Table Sizes

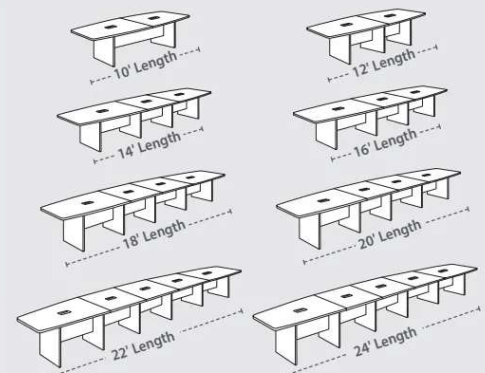

Additional Sizes Available - Call For Details

### OPTIONAL POWER

#### Power Insert PLTBPOWER

Cutout: 9½"W x 4½"D  
Overall: 10¾"W x 4¾"D  
List: \$874.00



Available In SI Silver & BK Black (See page 231 for details)

Note: This product can be shipped by a small package carrier.



NEW! AE American Elm  
(†Select SKUs)

CG Coastal Gray

ES Espresso

MW Modern Walnut

MH Mahogany  
(Select SKUs)

CH Cherry  
(Select SKUs)

WH White  
(Select SKUs)

MA Maple  
(Select SKUs)

Note: American Elm **only** available for select SKUs. Select SKUs are notated by a † mark at the end of their SKU.



## PALISADES

Pictured w/Palma Seating & Palisades Bookcases

**A 96"W Standing Height Table** (Not Pictured)  
(6 Cutouts for EVT900BK)  
**EVST8**  
95¼"W x 47¼"D x 42"H  
List: \$5,346.00

**B 72"W Sitting Height Conference Table**  
(Pre-cut Grommet Insert + Cover)  
**EVT6**  
72"W x 47¼"D x 29¾"H  
List: \$2,814.00



**C 96"W Sitting Height Conference Table**  
(2 Pre-cut Grommet Inserts + Covers)  
**EVT8**  
95¼"W x 47¼"D x 29¾"H  
List: \$2,943.00

**D 120"W Sitting Height Conference Table**  
(2 Pre-cut Grommet Inserts + Covers)  
**EVT10**  
120"W x 47¼"D x 29¾"H  
List: \$5,080.00



**OPTIONAL POWER**  
**Daisy Chain Power Module**  
(For EVST8 Only)  
**EVT900BK** (Black Only)  
List: \$660.00

Note: Daisy chained up to (3) power modules only. Power modules are sold separately as a set of (3).

**E 42"W Round Conference Table**  
**EV42R**  
42"W x 42"D x 29¾"H  
List: \$1,215.00



GG Gauntlet Gray  
w/Graphite Metal

Note: **PLTBPOWER** is an optional power insert option that fits **EVT6**, **EVT8** & **EVT10**.

This product is part of a complete collection.  
See Pages 20-23

## ROWLAND

**A 48"W Conference Table**  
**CM2048**  
48"W x 48"D x 30"H  
List: \$3,075.00



Multiple tables can be put together to create your desired length.



MH Mahogany

This product is part of a complete collection.  
See Pages 4-5



Pictured w/(2) CM2048 - ROWLAND4





## OS CONFERENCE / MULTI-PURPOSE

**NEW! Conference Typical  
OSTYP305†**  
Total List: \$2,796.00  
95"W x 72"D x 72"H  
Includes: (1) PL236 & (2) PL156  
Excludes Seating & Accessories  
Pictured w/Oslo Seating

## Design Your Own With OfficeSource®

A well designed meeting room can facilitate great discussions, idea generation, productive meetings, and even just a place to relax. The perfect conference table can help create a professional environment when interacting with clients or customers. The perfect multi-purpose table can create an atmosphere for collaboration and to enjoy a break or a meal.

### TABLE LEG BASE OPTIONS

Several different table bases to choose from with varying finish options.

1. Flat "T" Metal Leg Base - (Silver & Matte Black)
2. Cube Laminate Base - (8 Finishes - Select SKUs)
3. "X" Laminate Base - (6 Finishes - Select SKUs)
4. Oblique Style Wood Base - (Modern Walnut & Coastal Gray)
5. Oblique Style Metal Base - (Silver & Matte Black)
6. 41" Oblique Style Metal Base - (Silver & Matte Black)
7. Unite Style Base - 28½" - (Silver & Matte Black)
8. Unite Style Base - 41" - (Silver Only)
9. Beveled Leg Base - (Silver & Matte Black)
10. Board Style Base - (Brushed Aluminum & Matte Black)
11. Tri-Leg Base - (Silver Only)
12. Cross Base - (Matte Silver & Matte Black)
13. 4 Prong Base - (Brushed Aluminum)
14. Round Base - (Brushed Aluminum & Matte Black)
15. Square Base - (Brushed Aluminum)
16. Slab End Panel Laminate Base - (8 Finishes)
17. 18" Or 28" Hairpin Leg Base - (Silver & Matte Black)

### SEVERAL TOP SHAPES & SIZES

Choose from Rectangular, Boat Shaped, Half Boat Shaped, Round, Square & Clear Glass



Pictured w/NEW! American Elm Finish

## Configure Your Way!

# OS CONFERENCE/MULTI-PURPOSE TABLES

Custom Build Your Training Or Multi-Purpose Table By Combining Table Tops & Bases

Pictured w/PL235T Top



**Slab Style Bases**  
**PL35EMODSB (1)**  
 Available in 8 Finishes  
 Shown in NEW! American Elm

Pictured w/PLT Top



**41" Oblique Style Bases**  
**PLTVAMETLEG41A1 (2) &**  
**PLTVALEGM243041CB (2)**  
 Available in Matte Black or Silver Metal

Note: 41" Oblique Legs Require Beams. (See Page 119)



Cube Bases Provide  
 Easy Access To Cords

**Cube Style Bases**  
**PLCUBED20 (2)**  
 Available in Standard Height 28"H  
 or Café Height 41"H



**Board Style Bases**  
**PLTBTB32 (2)**  
 Available in Matte Black or Brushed Aluminum



**Oblique Style Bases**  
**PLTVAWLEG (3) & PLTVALEGM3642 (3)**  
 Available in Wood or Metal Finishes  
 Note: Oblique Legs Require Beams. (See Page 119)



Note: Oblique Legs & Unite  
 Inset Legs Require Beams.  
 (See Page 119)

**Oblique Style Bases w/Unite Inset Base**  
**PLTVAMETLEG (2), PLTVALEGM3642 (2)**  
**& PLTULEG4860ILCMB (2)**  
 Can be combined with Unite Inset Legs



Note: American Elm only available for select SKUs. Select SKUs are notated by a † mark at the end of their SKU.

Some items in this collection come ready-to-assemble.

Round Multi-Purpose Top



**X Style Base**  
**PLWXB3642**  
 Available in  
 Standard or Café Height

Square Conference Top  
 (Pictured w/PL139T Top)



**Cube Style Base**  
**PLCUBED2040**  
 Available in  
 Standard or Café Height





## OS CONFERENCE/MULTI-PURPOSE TABLES

*Pictured w/NEW! Jola Seating & NEW! OSTYP331 Typical*

**OfficeSource® Tables are put to use in many different ways.**

**Great Options for Both Style and Versatility.**

Breakroom • Classroom • Office • Training • Lobby

### RECTANGULAR GLASS TOP

**Rectangular "Tempered" Black Top (Thickness 12MM)**  
**PGT2460** Rectangular Glass Top 60"W x 24"D x 1½"H \$1,050.00

*Rectangular Glass Top only works well with 24"D Beveled Leg Bases & Unite Leg Bases.*

*Note: Beveled & Unite leg bases require beams & brackets. (See Page 119)*



Glass Top  
w/Beveled Base  
**PGT2460BK x1**  
**PLTLEGBV24SI x2**  
**PLTCBBEV x2**  
**PLTADJMDB4872 x1**



BK Black



Rectangular Top



Boat Shaped Conference Top



Square Multi-Purpose Top



Round Multi-Purpose Top



Square Conference Top



Half Boat Shaped Top

**Laminate Conference Tops  
Include PVC Tough Edge  
Ensures Long-lasting Durability**



Round Clear Glass Top

### CONFERENCE TOPS

#### Boat Shaped Conference Tops

<b>PL235T†</b>	6' Boat Shape Top	71"W x 36"D x 1½"H	\$487.00
<b>PL236T†</b>	8' Boat Shape Top	95"W x 44"D x 1½"H	\$805.00
<b>PL237HALF†*</b>	5' Boat Shape Top	60"W x 47¼"D x 1½"H	\$776.00
<b>PL238HALF†*</b>	6' Boat Shape Top	71"W x 47¼"D x 1½"H	\$1,063.00

*\*Note: Two half tops needed to make a 10' or 12' table.*

#### Square & Rectangular Conference Tops

<b>PL139T†</b>	4' Square Top	47¼"W x 47¼"D x 1½"H	\$791.00
<b>PL437HALF†*</b>	Half Rectangular Top	60"W x 47"D x 1½"H	\$735.00
<b>PL438HALF†*</b>	Half Rectangular Top	71"W x 47"D x 1½"H	\$1,031.00

*Note: Grommets standard on all conference tops, including half tops.*



AE American Elm  
NEW! (†Select SKUs)    CG Coastal Gray    ES Espresso    MW Modern Walnut



MH Mahogany    CH Cherry    WH White    MA Maple

### MULTI-PURPOSE TOPS

#### Rectangular Tops

<b>PLT2460†</b>	Rectangular Top	60"W x 24"D x 1"H	\$405.00
<b>PLT2466†</b>	Rectangular Top	66"W x 24"D x 1"H	\$443.00
<b>PLT2472†</b>	Rectangular Top	72"W x 24"D x 1"H	\$443.00
<b>PLT3060†</b>	Rectangular Top	60"W x 30"D x 1"H	\$487.00
<b>PLT3066†</b>	Rectangular Top	66"W x 30"D x 1"H	\$519.00
<b>PLT3072†</b>	Rectangular Top	72"W x 30"D x 1"H	\$519.00

#### Round & Square Tops

<b>PLT30R</b>	30" Round Top	30" Dia x 1"H	\$282.00
<b>PLT36R†</b>	36" Round Top	36" Dia x 1"H	\$315.00
<b>PLT42R†</b>	42" Round Top	42" Dia x 1"H	\$360.00
<b>PLT48R†</b>	48" Round Top	48" Dia x 1"H	\$443.00
<b>PGT24RCLEAR</b>	24" Round Glass	24" Dia x ½"H	\$543.00
<b>PGT36RCLEAR</b>	36" Round Glass	36" Dia x ½"H	\$708.00
<b>PLT30S</b>	30" Square Top	30"W x 30"D x 1"H	\$282.00
<b>PLT36S†</b>	36" Square Top	36"W x 36"D x 1"H	\$315.00
<b>PLT42S</b>	42" Square Top	42"W x 42"D x 1"H	\$360.00
<b>PLT48S</b>	48" Square Top	48"W x 48"D x 1"H	\$443.00

*Note: Round glass tops compatible with PLTRB2319, PLTSQ2319, PLTHDXB2319 & PLTHDXB3019 bases only. Multi-purpose tops do not come with grommets.*

*Note: American Elm only available for select SKUs. Select SKUs are notated by a † mark at the end of their SKU.*

# OS CONFERENCE/MULTI-PURPOSE TABLES

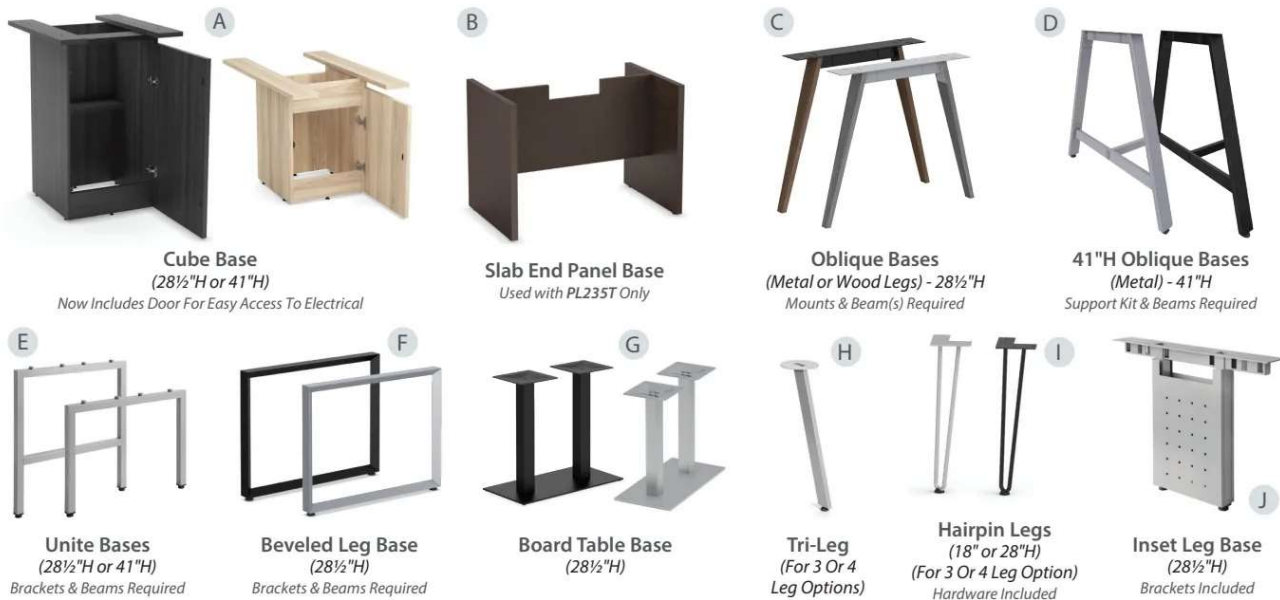

\*Note: Certain Bases Require Beams & Brackets. See Page 119 for more details.

Note: Hairpin Legs & Flat Metal "T" Leg bases can be shipped by a small package carrier. 📦

**A Cube Laminate Table Base - 28½ & 41"H**  
**PLCUBED20†** 19½"W x 19½"D x 28½"H \$635.00  
**PLCUBED2040** 19½"W x 19½"D x 41"H \$709.00  
*Note: Café Height Base can be used with rectangular tops, but require two bases. Table base heights do not include top, add top thickness of 1" for complete table height. Two bases are required for PLCUBED20 & PLCUBED2040 to be used with 6' conference table tops.*  
 PLCUBED2040 available in CG Coastal Gray, ES Espresso, MW Modern Walnut & WH White only

**B Slab End Panel Laminate Base - 28"H**  
**PL35EMODSB†** 38¼"W x 23¾"D x 28½"H \$335.00  
*Note: Slab End Panel Base used with PL235T only.*  
 Available in CH Cherry, MH Mahogany, ES Espresso, MA Maple, MW Modern Walnut, CG Coastal Gray, WH White & NEW! AE American Elm

**C Oblique Legs - 28½"H**  
**PLTVAMETLEG\*** (Metal Legs) \$140.00  
**PLTVAWLEG\*** (Wood Legs) \$154.00  
 Available in SI Silver, BK Matte Black, MW Modern Walnut & CG Coastal Gray  
*Note: Oblique Legs require PLTVALEGM leg mounts.*

**D Oblique Legs - 41"H**  
**PLTVAMETLEG41A1\*** (Metal Legs) \$191.00  
*Note: 41" Metal Oblique Legs require Support Leg Kit. Legs require at least (2) Adjustable Beams when used. Support Leg Kit contains cross beam & leg mount.*  
 Available in SI Silver & BK Matte Black

**E Unite Leg Bases - 41"H**  
**PLTULEG2441A1\*** (For 24"D Tops) \$375.00  
**PLTULEG3041\*** (For 30"D Tops) \$384.00  
**PLTULEG3641\*** (For 36"D Tops) \$506.00  
 Available in SI Silver Only

**Unite Leg Bases - 28½"H**  
**PLTULEG24\*** (For 24"D Tops) \$326.00  
**PLTULEG30\*** (For 30"D Tops) \$341.00  
**PLTULEG36\*** (For 36"D Tops) \$464.00  
**PLTULEG48\*** (For (2) 24"D Tops) \$492.00  
**PLTULEG60\*** (For (2) 30"D Tops) \$522.00  
 Available in SI Silver & BK Matte Black

**F Beveled Leg Base**  
**PLTLEGBV24\*** (For 24"D Tops) \$448.00  
**PLTLEGBV30\*** (For 30"D Tops) \$501.00  
**PLTLEGBV36\*** (For 36"D Tops) \$626.00  
**PLTLEGBV48\*** (For (2) 24"D Tops) \$750.00  
**PLTLEGBV60\*** (For (2) 30"D Tops) \$827.00  
 Available in SI Silver & BK Matte Black

**G Board Table Base**  
**PLTBTB32** 1"W x 5"D x 28½"H \$937.00  
 Available in BA Brushed Aluminum & BK Matte Black

**H Tri-Leg - Single Leg**  
**PLTVLEG128\*** 32"W x 16"D x 28½"H \$136.00  
 Available in SI Silver Only

**I Hairpin Leg (Set of 4)**  
**HP18LEG** 18"H \$352.00  
**HP28LEG** 28"H \$448.00  
 Available in SI Silver & BK Matte Black

**J Inset Leg - 28½"H**  
**PLTULEG4860LCMB\*** \$737.00  
 (Includes Removable Wire Management Cover & PLTMBMBC Brackets)  
 Available in SI Silver Only

**K Flat Metal "T" Leg Base**  
 - (For 24"D & 30"D Tops)  
**OSFTLEG24** \$528.00 ctn.  
 23¾"W x 6"D x 28½"H  
**OSFTLEG30** \$658.00 ctn.  
 28"W x 6"D x 28½"H  
*Note: Flat Metal "T" Leg Base Priced (2) Per Carton. Tops 60" or larger require the purchase of stiffener bars.*  
 Available in SI Silver & BK Matte Black



Laminate Base Finishes

Metal Leg Base Finishes

Oblique Wood Leg Base Only Finishes



Note: American Elm only available for select SKUs. Select SKUs are notated by a † mark at the end of their SKU.



## OS CONFERENCE/MULTI-PURPOSE TABLES



Pictured w/PL438 Conference Table & Veneto Seating - Page 197



Pictured w/PL437 Conference Table & Boxero Seating - Page 204



Pictured w/PL437 Conference Table & Oslo Seating - Page 177



Pictured w/PL437 Conference Table & Merak Seating - Page 201

### Table Hardware - Beams & Supports for Oblique, Beveled & Unite Leg Bases



**Adjustable Beam**  
**PLTADJMDB4872\***  
 (Extends For Desks 48-72"W)  
 List: \$181.00 ea.

**PLTADJMDB7896\***  
 (Extends For Returns 78-96"W  
 & 48" Bridge Tops)  
 List: \$224.00 ea.

**Beam Cover**  
 (Cover To Conceal Adj. Beam  
 & Hardware For 72"W Tops Only)  
**PLTMDB72C\*** (Not Pictured)  
 List: \$154.00 ea.



**Return Bracket**  
**PLTRBB\*** (For Adjustable Beams)  
 List: \$64.00 ea.  
 Note: Includes (2) PLTFB.



**Return Support**  
**PLTRET SUPPORTSI** (Silver Only)  
 10 $\frac{1}{8}$ "W x 7"D x 2 $\frac{1}{8}$ "H  
 List: \$87.00 ea.



**Connector Beam Bracket**  
**PLTCBBEVS** (Silver Only)  
 (Required For Beveled Leg Base)  
 List: \$83.00 ea.  
 Note: 1 or 2 Required  
 Depending On Usage.



**Connector Beam Bracket**  
**PLTMBMBCSI** (Pair - Silver Only)  
 (For Oblique & Inset Legs)  
 List: \$70.00 ea.



**Connector Beam Bracket**  
**PLTCBBSINGLE\***  
 (For Unite Leg Base)  
 List: \$56.00 ea.  
 Note: 1 or 2 Required  
 Depending On Usage.

**Support Leg Kit**  
 (For 41"H Oblique Legs Only)  
**PLTVALEGM243041CB\***  
 (For 24-30"D Tops)  
 List: \$245.00 ea.  
**PLTVALEGM364241CB\***  
 (For 36-42"D Tops)  
 List: \$332.00 ea.  
**PLTVALEGM486041CB\***  
 (For 48-60"D Tops)  
 List: \$451.00 ea.



**Oblique Leg Mounts**  
**PLTVALEGM2430\***  
 (For 24-30"D Tops)  
 List: \$140.00 ea.

**PLTVALEGM3642\***  
 (For 36-42"D Tops)  
 List: \$169.00 ea.

**PLTVALEGM4860\***  
 (For 48-60"D Tops)  
 List: \$253.00 ea.

Note: Required for  
 both Metal & Wood  
 Oblique Legs.

#### Hardware Finishes



BK Black  
 (\*Select SKUs)

SI Silver

# OS CONFERENCE/MULTI-PURPOSE TABLES

## Standard Height Bases

All metal bases available in Standard or Café height; Round, Square & 4 Prong also available in occasional height.



### CROSS BASES

PLTXBM24	Standard Base - Black (Fits up to 36" Tops)	\$326.00
PLTXBM24	Standard Base - Silver (Fits up to 36" Tops)	\$326.00
PLTXBM33	Standard Base - Black (Fits up to 48" Tops)	\$357.00
PLTXBM33	Standard Base - Silver (Fits up to 48" Tops)	\$357.00
PLTXBM3341	Café Height Base - Black (Fits up to 36" Tops)	\$448.00
PLTXBM3341	Café Height Base - Silver (Fits up to 36" Tops)	\$448.00

Available In SI Matte Silver & BK Matte Black

### 4 PRONG BASES

PLTHDXB2319	Occasional Height Base (Fits up to 36" Tops)	\$739.00
PLTHDXB2328	Standard Base (Fits up to 36" Tops)	\$771.00
PLTHDXB2341	Café Height Base (Fits up to 30" Tops)	\$880.00
PLTHDXB3019	Occasional Height Base (Fits up to 48" Tops)	\$925.00
PLTHDXB3028	Standard Base (Fits up to 48" Tops)	\$957.00
PLTHDXB3041	Café Height Base (Fits up to 36" Tops)	\$1,066.00

Note: Café Height Base Can Be Used With Rectangular Tops, But Require Two Bases. Available In BA Brushed Aluminum

### ROUND & SQUARE BASES

PLTRB2319	Occasional Height Round Base (Fits up to 36" Tops)	\$684.00
PLTRB2328	Standard Round Base (Fits up to 42" Tops)	\$704.00
PLTRB2341	Café Height Round Base (Fits up to 30" Tops)	\$752.00
PLTSQ2319	Occasional Height Square Base (Fits up to 36" Tops)	\$742.00
PLTSQ2328	Standard Square Base (Fits up to 42" Tops)	\$744.00
PLTSQ2341	Café Height Square Base (Fits up to 30" Tops)	\$823.00

Round Bases Available In BA Brushed Aluminum & BK Matte Black  
Square Bases Available in BA Brushed Aluminum Only

### X TABLE BASES

PLWXB3642†	X Base (For 36" & 42" Tops)	\$285.00
PLWXB48	X Base (For 48" Top)	\$357.00

Available In CH Cherry, MH Mahogany, ES Espresso, MW Modern Walnut, CG Coastal Gray & NEW! AE American Elm (PLWXB3642 Only).

Note: American Elm only available for select SKUs. Select SKUs are notated by a † mark at the end of their SKU.

Note: PLTRB2328 & PLTRB2341 table bases can be shipped by a small package carrier.



# OS CONFERENCE/MULTI-PURPOSE TABLES

Base Styles (17 Base Options)

Work Surfaces (Variety of Shapes & Sizes, 8 Finishes)





## OS CONFERENCE/MULTI-PURPOSE TABLES

**NEW! Multi-Purpose Typical  
OSTYP331†**  
Total List: \$14,511.00  
72"W x 24"D x 42"H  
Excludes Seating & Accessories  
Pictured w/NEW! Jola Seating



Pictured w/CoolMesh Seating

### NEW! OSTYP331 | Components

SKU #	QTY	DESCRIPTION	W x D x H
PLT2472†	5	Rectangular Top	72 x 24 x 1
PLT36R†	4	36" Round Top	36 x 42 x 1
PLT72MSBK	5	Stiffener Support (Set of 2)	60½ x 2¼ x 1
PLTRB2328	4	Standard Round Base	22¾ x 22¾ x 19
PLTRB2341	10	Café Height Round Base	22¾ x 22¾ x 41

### Conference Typical OSC25†

Total List: \$822.00  
71"W x 36"D x 29½"H  
Excludes Seating & Accessories



Pictured w/Perch Seating

### OSC25 | Components

SKU #	QTY	DESCRIPTION	W x D x H
PL235T†	1	6' Boat Shaped Top	71 x 36 x 1½
PL35EMODS8†	1	Slab Laminate Base	38¼ x 23¾ x 28½

### Multi-Purpose Typical OSC12†

Total List: \$3,698.00  
72"W x 36"D x 29½"H  
Excludes Seating & Accessories

### OSC12 | Components

SKU #	QTY	DESCRIPTION	W x D x H
PLT3672†	2	Rectangular Top	72 x 36 x 1½
PLTULEG36	4	Unite Leg Base (For 36"D Tops)	28½"H
PLTADJMDB4872	2	Adjustable Beam	67¾ x 2 x 1
PLTCBBSINGLE	4	Connector Beam Bracket	

Note: American Elm only available for select SKUs. Select SKUs are notated by a † mark at the end of their SKU.





**OS CONFERENCE/MULTI-PURPOSE TABLES**

**Conference Typical  
OSC18†**  
Total List: \$2,679.00  
95"W x 44"D x 29½"H  
Excludes Seating & Accessories  
Pictured w/Cade Seating



**OSC18 | Components**

SKU #	QTY	DESCRIPTION	W x D x H
PLTBTB32	2	Board Table Base	32 x 16 x 28½
PL236T†	1	Boat Shaped Conference Top	95 x 44 x 1½

**Conference Typical  
OSC30†**

Total List: \$2,046.00  
132"W x 30"D x 29"H  
Excludes Accessories  
*\*Note: Only (6) out of the (8) HP28LEG are needed to be used in this typical. You will have (2) extra left.*



*Pictured w/Parson Seating*

**OSC30 | Components**

SKU #	QTY	DESCRIPTION	W x D x H
PLT3066†	2	Rectangular Top	66 x 30 x 1
HP28LEG	2	Hairpin Legs (Set of 4)	6 x 6 x 28"H
PLT60MS	1	Stiffener Support (Set of 2)	48 x 2¼ x 1

**Conference Typical  
OSC31†**

Total List: \$5,379.00  
189"W x 47¼"D x 29½"H  
Excludes Seating & Accessories

**OSC31 | Components**

SKU #	QTY	DESCRIPTION	W x D x H
PLTVAMETLEG	4	Oblique Metal Legs	1 x 3 x 29¾
PLTVALEGM3642	4	Oblique Leg Mounts	
PLTMBMBC	2	Connector Beam Bracket (Set of 2)	
PL238THALF†	2	6' Boat Shape Top	71 x 47¼ x 1½
PL139T†	1	4' Square Top Section	47¼ x 47¼ x 1½
PLTADJMDB4872	6	Adjustable Beam	67¾ x 2 x 1

Note: American Elm only available for select SKUs. Select SKUs are notated by a † mark at the end of their SKU.



## OS CONFERENCE/MULTI-PURPOSE TABLES

**Conference Typical  
OSC04†**  
Total List: \$6,248.00  
236¼"W x 47¼"D x 29½"H  
Excludes Seating & Accessories  
Pictured w/Cade Seating



*Pictured w/CoolMesh Seating*

### OSC04 | Components

SKU #	QTY	DESCRIPTION	W x D x H
PL238THALF†	2	6' Boat Shape Top	71 x 47¼ x 1½
PLCUBED20†	4	Cube Table Base w/Access Door	19½ x 19½ x 28
PL139T†	2	4' Square Top Section	47¼ x 47¼ x 1½

**Conference Typical  
OSC27†**  
Total List: \$1,426.00  
47"W x 47"D x 30"H  
Excludes Seating & Accessories

### OSC27 | Components

SKU #	QTY	DESCRIPTION	W x D x H
PL139T†	1	4' Square Top Section	47¼ x 47¼ x 1½
PLCUBED20†	1	Cube Table Base w/Access Door	19½ x 19½ x 28



*Pictured w/Stacked Seating & Rise Seating*

**NEW! Multi-Purpose Typical  
OSTYP314†**  
Total List: \$9,456.00  
216"W x 41"H  
Individual Table - Occasional: 36"W x 42"D x 19"H  
Individual Table - Café: 36"W x 42"D x 41"H  
Excludes Seating & Accessories

### NEW! OSTYP314 | Components

SKU #	QTY	DESCRIPTION	W x D x H
PLT36R†	3	36" Round Top	36 x 42 x 1
PLT3060†	3	Rectangular Top	60 x 30 x 1½
PLTRB2328	3	Standard Round Base	22½ x 22½ x 19
PLTSQ2341	6	Café Height Square Base	22¾ x 22¾ x 41

Note: American Elm only available for select SKUs. Select SKUs are notated by a † mark at the end of their SKU.





OS CONFERENCE/MULTI-PURPOSE TABLES

**NEW! Multi-Purpose Typical  
OSTYP315†**  
Total List: \$8,532.00  
144"W x 41"H  
Excludes Seating & Accessories  
Pictured w/Willow Seating



Pictured w/Tre Lite Seating

Note: American Elm only available for select SKUs. Select SKUs are notated by a † mark at the end of their SKU.



Pictured w/Willow Seating & Tribeca Seating

OSTYP330 is not available in AE American Elm.

**NEW! OSTYP315** | Components

SKU #	QTY	DESCRIPTION	W x D x H
PLT3060†	4	Rectangular Top	60 x 30 x 1½
PLTSQ2341	8	Café Height Square Base	22¾ x 22¾ x 41

**NEW! Conference Typical  
OSTYP313†**  
Total List: \$8,123.00  
142"W x 29½"H  
Excludes Seating & Accessories

**NEW! OSTYP313** | Components

SKU #	QTY	DESCRIPTION	W x D x H
PL237THALF†	2	5' Boat Shape Top	60 x 47¼ x 1½
PLTVALEGM3642	3	Oblique Leg Mounts	
PLTVAMETLEG	3	Oblique Metal Leg Base (Set of 2)	1 x 3 x 28½
PLTMBMBC	1	Connector Beam Bracket (Pair)	
PLTADJMDB4872	4	Adjustable Beam	67½ x 2 x 1
PL152†	4	Storage Cabinet	35½ x 22 x 37¼
PL110†	2	File/Storage Top	71 x 22 x 1

**NEW! Multi-Purpose Typical  
OSTYP330**  
Total List: \$17,176.00  
216"W x 96"D x 42"H  
Excludes Seating & Accessories

**NEW! OSTYP330** | Components

SKU #	QTY	DESCRIPTION	W x D x H
PLTULEG60	2	Unite Leg Base (For 36"D Tops)	60 x 1½ x 28½
PLTULEG4860ILCMB	2	Inset Leg Base	35 x 5 x 28½
PLTCBBSINGLE	22	Connector Beam Bracket	
PLTADJMDB4872	15	Adjustable Beam	67½ x 2 x 1
PLT3072†	6	Rectangular Top	72 x 30 x 1
PLTMBMBC	4	Connector Beam Bracket (Pair)	
PLTRB2319	2	Occasional Round Base	22¾ x 22¾ x 19
PLT305	2	30" Square Top	30 x 42 x 1
PLTMDB72C	3	Beam Cover	67½ x 1¼ x 23½
PLT3672†	3	Rectangular Top	72 x 36 x 1
PLTULEG3641	6	Unite Leg Base (For 36"D Tops)	36 x 1½ x 41

## OS CONFERENCE/MULTI-PURPOSE TABLES



*Pictured w/Slash Seating*

### Multi-Purpose Typical

#### OSC16†

Total List: \$12,042.00

72"W x 30"D x 29½"H

*Excludes Seating & Accessories*

### OSC16 | Components

SKU #	QTY	DESCRIPTION	W x D x H
PLT3072†	6	Rectangular Top	72 x 30 x 1
PLTSQ2328	12	Standard Square Base	22¼ x 22¼ x 28½



*Pictured w/Stacked Seating & Rise Seating*

### Multi-Purpose Typical

#### OSC33†

Total List: \$2,808.00

Individual Table - Regular: 36"W x 42"D x 28½"H

Individual Table - Café: 36"W x 42"D x 41"H

*Excludes Seating & Accessories*

### OSC33 | Components

SKU #	QTY	DESCRIPTION	W x D x H
PLT36R†	4	36" Round Top	36 x 42 x 1
PLTXBM3341	2	Café Height Cross Base	33 x 33 x 41
PLTXBM24	2	Cross Base	24 x 24 x 28½



*Pictured w/Zella & Integrate Seating*

### Multi-Purpose Typical

#### OSC29

Total List: \$8,325.00

36"W x 36"D x 29½"H

*Excludes Seating & Accessories*

### OSC29 | Components

SKU #	QTY	DESCRIPTION	W x D x H
PLTHXB3028	5	Standard 4 Prong Base	29¾ x 11¼ x 28
PGT36RCLEAR	5	36" Round Glass Top	36 x 36 x 1

Note: American Elm only available for select SKUs. Select SKUs are notated by a † mark at the end of their SKU.





## NEW! SOFIA

Pictured w/NEW! Jola, NEW! Matching Ottoman & Partridge Seating  
Shown w/Optional PLT3060 & PLT3072 tops in NEW! American Elm Finish

### A 60"W Conference Table OSXC2007

(Adjustable Foot Levelers Included)  
60"W x 30"D x 30<sup>15</sup>/<sub>16</sub>"H  
List: \$925.00

### B 60"W Low Mobile Collaboration Table OSXC2008

(Locking Nylon Casters Included)  
60"W x 30"D x 22<sup>1</sup>/<sub>16</sub>"H  
List: \$850.00

### C 72"W Low Mobile Collaboration Table OSXC2009

(Locking Nylon Casters Included)  
72"W x 30"D x 22<sup>1</sup>/<sub>16</sub>"H  
List: \$925.00

### D 42"H Standing Height Collaboration Table OSXC2010

(Adjustable Foot Levelers Included)  
72"W x 35<sup>7</sup>/<sub>16</sub>"D x 42"H  
List: \$1,050.00

### E Mobile Ottoman OSRL3003

Overall: 20"W x 20"D x 17<sup>3</sup>/<sub>4</sub>"H  
List: \$385.00

Available in CR Charcoal Only



Shown w/Standard Dove Gray Finish

## FEATURES

- Contemporary design with 1.8" thick tops and sides
- Full-length center support provides strength and durability
- Constructed with durable, melamine laminate
- Some assembly required



DV Dove Gray  
(Standard)

Give a **Dramatic Look** to Your Space!  
Add an OS Laminate Top to any Sofia table  
- tops are available in any finish option below



PLT3060 - Rectangular Top  
60"W x 30"D

(Compatible w/OSXC2007  
& OSXC2008)



PLT3072 - Rectangular Top  
72"W x 30"D

(Compatible w/OSXC2009 Only)



PLT3672 - Rectangular Top  
72"W x 36"D

(Compatible w/OSXC2010 Only)

### Optional Laminate Top Finishes



NEW! AE  
American Elm

CG Coastal Gray

ES Espresso

MW Modern Walnut



MH Mahogany

CH Cherry



WH White

MA Maple



Shown w/NEW! American Elm Laminate Top Finish



**OS PEDESTAL TABLES**  
Pictured w/ Dover Seating



Requires Base



A



B



C

**Laminate Table - Top**  
**PL9997†**  
29"W x 29"D x 12½"H  
List: \$501.00

**A Metal Pedestal - Table Base**  
**PL9998**  
29"W x 29"D x 18¼"H  
List: \$290.00

**B Caster Pedestal - Table Base**  
**PLPEDCASTERS**  
List: \$67.00

**C Angled Wood Mini Legs - Table Base**  
**PLTAWRLEG (Set of 4)**  
List: \$120.00

Available In **NO** Natural Oak, **MW** Modern Walnut & **CG** Coastal Gray

Note: Must choose one of the three base options: Metal, Caster or Angled Base.



**AE** American Elm  
**NEW!** (†Select SKUs)

**CG** Coastal Gray

**ES** Espresso

**MW** Modern Walnut

**MH** Mahogany

**CH** Cherry

**WH** White

**MA** Maple

Note: Casters & Mini Wood Legs can be shipped by a small package carrier.

Some items in this collection come ready-to-assemble.

## C-TABLE



**Laminate Side C-Table**  
**w/Silver Base**  
**PLTC66T†**  
22¼"W x 15¾"D x 25½"H  
List: \$375.00



Pictured w/ Manhattan Seating & OS Pedestal Table



**AE** American Elm  
**NEW!** (†Select SKUs)

**CG** Coastal Gray

**ES** Espresso

**MW** Modern Walnut

**MH** Mahogany

**CH** Cherry

**WH** White

**MA** Maple

Note: American Elm **only** available for select SKUs. Select SKUs are notated by a † mark at the end of their SKU.





## OS RECEPTION TABLES

*Pictured w/Round Clear Glass Top w/Round Base & Madison Seating*

### LAMINATE & GLASS TABLE TOPS

#### Round & Square Tops

<b>PLT30R</b>	30" Round Top	30" Dia x 1"H	\$282.00
<b>PLT36R†</b>	36" Round Top	36" Dia x 1"H	\$315.00
<b>PGT24RCLEAR</b>	24" Round Glass	24" Dia x ½"H	\$543.00
<b>PGT36RCLEAR</b>	36" Round Glass	36" Dia x ½"H	\$708.00
<b>PLT30S</b>	30" Square Top	30"W x 30"D x 1"H	\$282.00
<b>PLT36S†</b>	36" Square Top	36"W x 36"D x 1"H	\$315.00

*Note: Round glass tops come with metal center adapter.*

*Note: Round glass tops compatible with **PLTRB2319**, **PLTSQ2319**, **PLTHDXB2319** & **PLTHDXB3019** bases only.*

*Laminate Finishes are **CH** Cherry, **MH** Mahogany, **ES** Espresso, **MA** Maple, **MW** Modern Walnut, **CG** Coastal Gray, **WH** White & **NEW!** **AE** American Elm*

### ROUND & SQUARE BASES

<b>PLTRB2319</b>	Occasional Height Round Base (Fits up to 36" Tops)	\$684.00
<b>PLTSQ2319</b>	Occasional Height Square Base (Fits up to 36" Tops)	\$742.00

*Round Bases Available In **BA** Brushed Aluminum & **BK** Matte Black  
Square Bases Available in **BA** Brushed Aluminum Only*

### 4 PRONG BASES

<b>PLTHDXB2319</b>	Occasional Height Base (Fits up to 36" Tops)	\$739.00
<b>PLTHDXB3019</b>	Occasional Height Base (Fits up to 48" Tops)	\$925.00

*Note: Café Height Base Can Be Used With Rectangular Tops, But Require Two Bases.*

*Available In **BA** Brushed Aluminum*

*Note: American Elm only available for select SKUs. Select SKUs are noted by a † mark at the end of their SKU.*



*Pictured w/Sterling Seating*

#### **A 18"H Hairpin Leg Base (Set of 4)** *(For Laminate Tops Only)*

##### **HP18LEG**

List: \$352.00 ctn.

*Note: Hairpin Leg Bases Priced (4)  
Per Carton. Hardware Included.*

*Available In **SI** Silver & **BK** Matte Black*

*HP18LEG is not fully compatible  
with 36" table tops.  
Additional wood screws would  
be needed.*



## PALISADES

Pictured w/Partridge Seating

### A Coffee Table EV5550

47¼"W x 23⅜"D x 17"H  
List: \$1,148.00

### B End Table EV5500

20½"W x 20½"D x 26"H  
List: \$826.00



GG Gauntlet Gray  
w/Graphite Metal

This product is part of a complete collection.  
See Page 20-23

## PARALLEL

### A Coffee Table PL219

47¼"W x 23¾"D x 16"H  
List: \$628.00

### B End Table PL220†

23¾"W x 23¾"D x 20"H  
List: \$443.00



AE American Elm  
NEW! (†Select SKUs)

CG Coastal Gray

ES Espresso



MW Modern Walnut

MH Mahogany

CH Cherry

Note: American Elm only  
available for select SKUs.  
Select SKUs are noted  
by a † mark at the end of  
their SKU.



Pictured w/Tribeca Seating



# ROBUST



## INDOOR TABLE BASES

Standard Height - 29"H or Café Height - 41"H

QS2113030BW	Table Height - X	\$469.00
QS2113042BW	Café Height - X	\$511.00
QS2142230BW	Table Height - Round	\$555.00
QS2142242BW	Café Height - Round	\$597.00

Note: Both X and Round bases support up to 50" table tops.

## OUTDOOR TABLE BASES

Standard Height - 29"H or Café Height - 41"H

QSOD2113030BW	Table Height - X	\$781.00
QSOD2113042BW	Café Height - X	\$839.00
QSOD2142230BW	Table Height - Round	\$993.00
QSOD2142242BW	Café Height - Round	\$1,050.00

Note: Both X and Round bases support up to 50" table tops.

## CAFÉ HEIGHT X BASE

Indoor/Outdoor Café Height X Table Base w/Footing

QSOD2162042BW	24"W x 24"D x 42"H	List: \$1,012.00
---------------	--------------------	------------------

Note: Additional #8 type 3/4" wood screws are needed to be purchased separately for the assembly of bases. (8) qty. are required in total.

## INDOOR/OUTDOOR TABLE TOPS

Square - 30" & 36" Wide, Rectangular - 48" Wide; Circle 30" & 36" Diameter

QSOD30SQ	30"W x 30"D x 2"H (Square)	\$648.00
QSOD36SQ	36"W x 36"D x 2"H (Square)	\$731.00
QSOD3048	48"W x 30"D x 2"H (Rectangular)	\$827.00
QSOD30R	30"D x 2"H (Round)	\$593.00
QSOD36R	36"D x 2"H (Round)	\$690.00

## INDOOR/OUTDOOR CHAIRS

### A 30" Outdoor Backless Bar Stool

QSOD40530  
Overall: 17 1/4"W x 17 1/4"D x 30"H  
Seat: 14"W x 14"D x 30"H  
List: \$839.00

### B 30" Outdoor Bar Stool

QSOD40030  
Overall: 16"W x 18"D x 44"H  
Seat: 16 1/4"W x 16 1/4"D x 30"H  
List: \$991.00

### C 18" Outdoor Chair

QSOD40018  
Overall: 16"W x 18"D x 32"H  
Seat: 16 1/4"W x 16 1/4"D x 18"H  
List: \$856.00

Note: All items on this page can be shipped by a small package carrier.



QS = QUICKSHIP Most items in this collection come fully assembled.



## BLOW MOLDED FOLDING TABLES

Pictured w/Matching Blow Molded Folding Chairs - See Page 155

<b>A Plastic Blow Molded Folding Tables (Rectangular)</b>			
<b>FBM3060</b>	60"W x 30"D x 29"H	30 lbs.	\$314.00
<b>FBM3072</b>	72"W x 30"D x 29"H	36 lbs.	\$362.00
<b>FBM3096</b>	96"W x 30"D x 29"H	49 lbs.	\$529.00
<b>B Plastic Blow Molded Folding Tables (Round)</b>			
<b>FBM60R</b>	60"Dia x 29"H	49 lbs.	\$609.00
<b>FBM71R</b>	71"Dia x 29"H	75 lbs.	\$906.00



## TABLE CARTS



**Rectangular Table Cart**  
**FTD3502**  
 76"W x 31"D x 45¼"H  
 Weight: 74 lbs.  
 List: \$928.00  
*Available in GR Gray Only*



**Round Table Cart**  
**RA106A**  
 52"W x 32¾"D x 40½"H  
 Weight: 84 lbs.  
 List: \$943.00  
*Available in GR Gray Only*

## COLORFUL BLOW MOLDED FOLDING TABLES

<b>A R-Series Blow Molded Folding Tables (Fixed Height)</b>		
<b>QSR2448</b>	48"W x 24"D x 29"H	\$698.00
<b>QSR3060</b>	60"W x 30"D x 29"H	\$869.00
<b>QSR3072</b>	72"W x 30"D x 29"H	\$925.00
<b>B RA-Series Blow Molded Folding Tables (Adjustable Height)</b>		
<b>QsRA2448</b>	48"W x 24"D x 22-32"H	\$904.00
<b>QsRA3060</b>	60"W x 30"D x 22-32"H	\$1,084.00
<b>QsRA3072</b>	72"W x 30"D x 22-32"H	\$1,138.00

### FEATURES

- Integrated full-length steel frame
- J-Channel apron provides superior inner support for a solid top
- Maximum support from integrated steel ladder frame underneath the top
- Constructed with heavy-duty materials
- Made in the U.S.A.



Note: R2448, R3060, RA2448 & RA3060 can be shipped by a small package carrier.

QS = QUICKSHIP



# MELAMINE FOLDING TABLES

<b>QSCF1860M</b>	60"W x 18"D x 29"H	40 lbs.	\$636.00	
<b>QSCF1872M</b>	72"W x 18"D x 29"H	44 lbs.	\$663.00	
<b>QSCF1896M</b>	96"W x 18"D x 29"H	49 lbs.	\$752.00	
<b>QSCF2448M</b>	48"W x 24"D x 29"H	42 lbs.	\$586.00	
<b>QSCF2460M</b>	60"W x 24"D x 29"H	48 lbs.	\$663.00	
<b>QSCF2472M</b>	72"W x 24"D x 29"H	52 lbs.	\$698.00	
<b>QSCF2496M</b>	96"W x 24"D x 29"H	65 lbs.	\$760.00	
<b>QSCF3060M</b>	60"W x 30"D x 29"H	53 lbs.	\$650.00	
<b>QSCF3072M</b>	72"W x 30"D x 29"H	61 lbs.	\$684.00	
<b>QSCF3096M</b>	96"W x 30"D x 29"H	80 lbs.	\$787.00	
<b>QSCF60MR</b>	60"W x 60"D x 29"H	86 lbs.	\$1,234.00	

Note: CF1860M, CF1872M, CF2448M, CF2460M & T6060 can be shipped by a small package carrier.

## FEATURES

- Melamine top on 5/8" high density particle board core
- 1", 18 ga. steel pedestal legs on rectangular table tops
- 1 1/2", 14 ga. steel wishbone legs on round table bases
- Automatic lock-open mechanism
- Economical choice for light-duty home, office or retail use
- Made in the U.S.A.

## TABLE CARTS



**Flat Stacking Rectangular Table Cart**  
**QST3072**

72"W x 30"D x 37 1/4"H  
List: \$1,262.00

**QST3096**

90"W x 30"D x 37 1/4"H  
List: \$1,323.00

Available in BR Brown Only



**Edge Stacking Round Table Cart**  
**QST6060**

48"W x 28"D x 31"H  
List: \$1,387.00

Available in BR Brown Only



CF2448M - 48"W  
Shown in Medium Oak



CF1860M - 60"W  
Shown in Walnut



CF3096M - 96"W  
Shown in Gray Granite



CF60MR - 60"W  
Shown in Black Granite



**WB** Walnut  
w/Brown Frame  
(Black T-Mold)

**OB** Medium Oak  
w/Brown Frame  
(Brown T-Mold)

**BM** Black Granite  
w/Black Frame  
(Black T-Mold)

**GA** Gray Granite  
w/Gray Frame  
(Gray T-Mold)

**QS = QUICKSHIP**



## INTEGRATE

*Pictured w/OS Pedestal Tables & OS Reception Glass Tables*

### A Armless Chair 9780A

Overall: 24"W x 29½"D x 32"H  
Seat: 24"W x 20"D x 20"H  
List: \$1,335.00

*Note: All chairs come standard with silver post legs & ganging hardware is included.*

### B Chair Arm 972ARMA

Overall: 5½"W x 29½"D x 26"H  
List: \$430.00

### C Armless Wedge Chair w/Back on Large Side 9785A

Overall: 30¼"W x 29½"D x 32"H  
Seat: 24"W x 21½"D x 20"H  
List: \$1,353.00



BK Black  
Antimicrobial  
PU Leather

Some items in this collection come ready-to-assemble.



*Pictured w/OS Pedestal Tables, OS Laminate Reception & Crusader Seating*





## DRAPER

*Pictured w/OS Reception Glass Table*

### A Sofa w/Silver Metal Legs 9074F

Overall: 66"W x 30¾"D x 32¼"H  
Seat: 56¾"W x 20½"D x 19"H  
List: \$2,685.00

### B Club Chair w/Silver Metal Legs 9071F

Overall: 30¾"W x 30¾"D x 32¼"H  
Seat: 21¼"W x 20½"D x 19"H  
List: \$1,433.00



TP Taupe Fabric



BK Black Fabric



GN Kashmir  
Green Fabric



*Pictured w/OS Reception Laminate Table*



*Pictured w/Parallel Tables*



## MILLENNIAL

*Pictured w/OS Pedestal Tables*

**A Armless Chair w/Silver Metal Legs  
10511V**  
Overall: 26 $\frac{3}{8}$ "W x 26 $\frac{3}{8}$ "D x 30 $\frac{1}{2}$ "H  
List: \$1,005.00

**B Corner Chair w/Silver Metal Legs  
10519V**  
Overall: 26 $\frac{3}{8}$ "W x 26 $\frac{3}{8}$ "D x 30 $\frac{1}{2}$ "H  
List: \$1,101.00

**C Guest Chair w/Silver Metal Legs  
10520V**  
Overall: 29 $\frac{1}{8}$ "W x 27 $\frac{1}{2}$ "D x 30 $\frac{1}{2}$ "H  
List: \$1,218.00

**D Ottoman w/Silver Metal Legs  
10515V**  
Overall: 26 $\frac{3}{8}$ "W x 24 $\frac{1}{2}$ "D x 17 $\frac{1}{2}$ "H  
List: \$681.00



BK Black PU Leather

*Note: All chairs include ganging brackets.*

Note: All items on this page can be shipped by a small package carrier. 







## TRIBECA

*Pictured w/OS Reception Laminate Table & Tre Seating*

**A Sofa w/Silver Metal Legs  
9683A**

Overall: 71¼"W x 29"D x 32"H  
Seat: 61¾"W x 20"D x 17½"H  
List: \$3,415.00

**B Loveseat w/Silver Metal Legs  
9682A**

Overall: 51½"W x 29"D x 32"H  
Seat: 42"W x 20"D x 17½"H  
List: \$2,595.00

**C Club Chair w/Silver Metal Legs  
9681A**

Overall: 31½"W x 29"D x 32"H  
Seat: 21"W x 20"D x 17½"H  
List: \$1,844.00



## ADDITIONAL PRODUCTS



**D**

*Tablet Rotates  
A Complete 360  
Degree Swivel*

**D Club Chair w/Black Finished  
Tablet Arm & Silver Metal Legs  
9681TAA**

Overall: 31½"W x 29"D x 32"H  
Seat: 21"W x 20"D x 17½"H  
Tablet Arm: 15¾"W x 11¾"D x 26½"H  
List: \$2,204.00



*Pictured w/Parallel Tables*



## MANHATTAN

Pictured w/OS Pedestal Table & C-Table

### A Sofa w/Black Wood Legs

**9883L**

Overall: 75"W x 32½"D x 31"H  
 Seat: 62"W x 20½"D x 19½"H  
 List: \$3,423.00

### B Loveseat w/Black Wood Legs

**9882L**

Overall: 55"W x 32½"D x 31"H  
 Seat: 42"W x 20½"D x 19½"H  
 List: \$2,719.00

### C Club Chair w/Black Wood Legs

**9881L**

Overall: 34"W x 32½"D x 31"H  
 Seat: 20½"W x 20½"D x 19½"H  
 List: \$1,872.00

## FEATURES

- Cushioned top grain leather upholstery
- Heavy-duty pocket spring coil construction
- Webbed seat & back
- Black wood finished legs



LT Latte  
Top Grain Leather

BK Black  
Top Grain Leather



Pictured w/OS Pedestal Table & C-Table

## ADDITIONAL PRODUCTS

### Laminate Side C-Table w/Silver Base

**PLTC66T†**

22¼"W x 15¾"D x 25½"H  
 List: \$375.00



For more details on this product, See Page 128

Note: American Elm **only** available for select SKUs. Select SKUs are notated by a † mark at the end of their SKU.





## MADISON

*Pictured w/OS Reception Glass Table*

**A Sofa w/Chrome Frame  
9283A**

Overall: 76"W x 32"D x 27"H  
Seat: 63"W x 22"D x 17¾"H  
List: \$4,225.00

**B Loveseat w/Chrome Frame  
9282A**

Overall: 55"W x 32"D x 27"H  
Seat: 41¾"W x 22"D x 17¾"H  
List: \$3,229.00

**C Club Chair w/Chrome Frame  
9281A**

Overall: 34½"W x 32"D x 27"H  
Seat: 21"W x 22"D x 17¾"H  
List: \$2,256.00



**BK Black**  
Antimicrobial  
PU Leather



**GT Light Gray**  
Antimicrobial  
PU Leather



*Pictured w/OS Reception Laminate Table & OS Laminate Storage*



## STERLING

Pictured w/OS Reception Glass Tables

### A Sofa w/Brushed Chrome Legs 62621L

Overall: 79½"W x 33⅝"D x 32⅞"H  
Seat: 66⅝"W x 20½"D x 17⅝"H  
List: \$3,486.00

### B Loveseat w/Brushed Chrome Legs 62611L

Overall: 58⅞"W x 33⅝"D x 32⅞"H  
Seat: 44⅝"W x 20½"D x 17⅝"H  
List: \$2,489.00

### C Club Chair w/Brushed Chrome Legs 62601L

Overall: 35⅞"W x 33⅝"D x 32⅞"H  
Seat: 23¼"W x 20½"D x 17⅝"H  
List: \$1,680.00



BK Black PU Leather

Note: 62601L can be shipped by a small package carrier. 

## FRAMED

### A Club Chair w/Matte Black Metal Frame 9285F

Overall: 34¼"W x 32"D x 27"H  
Seat: 20⅞"W x 22½"D x 17¾"H  
List: \$1,887.00



GT Light Gray Fabric







DEFINE

**A Sofa w/Silver Metal Legs**  
**9703V**  
 Overall: 73"W x 32"D x 31"H  
 Seat: 64½"W x 20½"D x 18½"H  
 List: \$2,615.00

**B Loveseat w/Silver Metal Legs**  
**9702V**  
 Overall: 50"W x 32"D x 31"H  
 Seat: 43"W x 20½"D x 18½"H  
 List: \$2,028.00

**C Club Chair w/Silver Metal Legs**  
**9701V**  
 Overall: 31¼"W x 32"D x 31"H  
 Seat: 23"W x 20½"D x 18½"H  
 List: \$1,371.00



BK Black PU Leather



GR Gray PU Leather

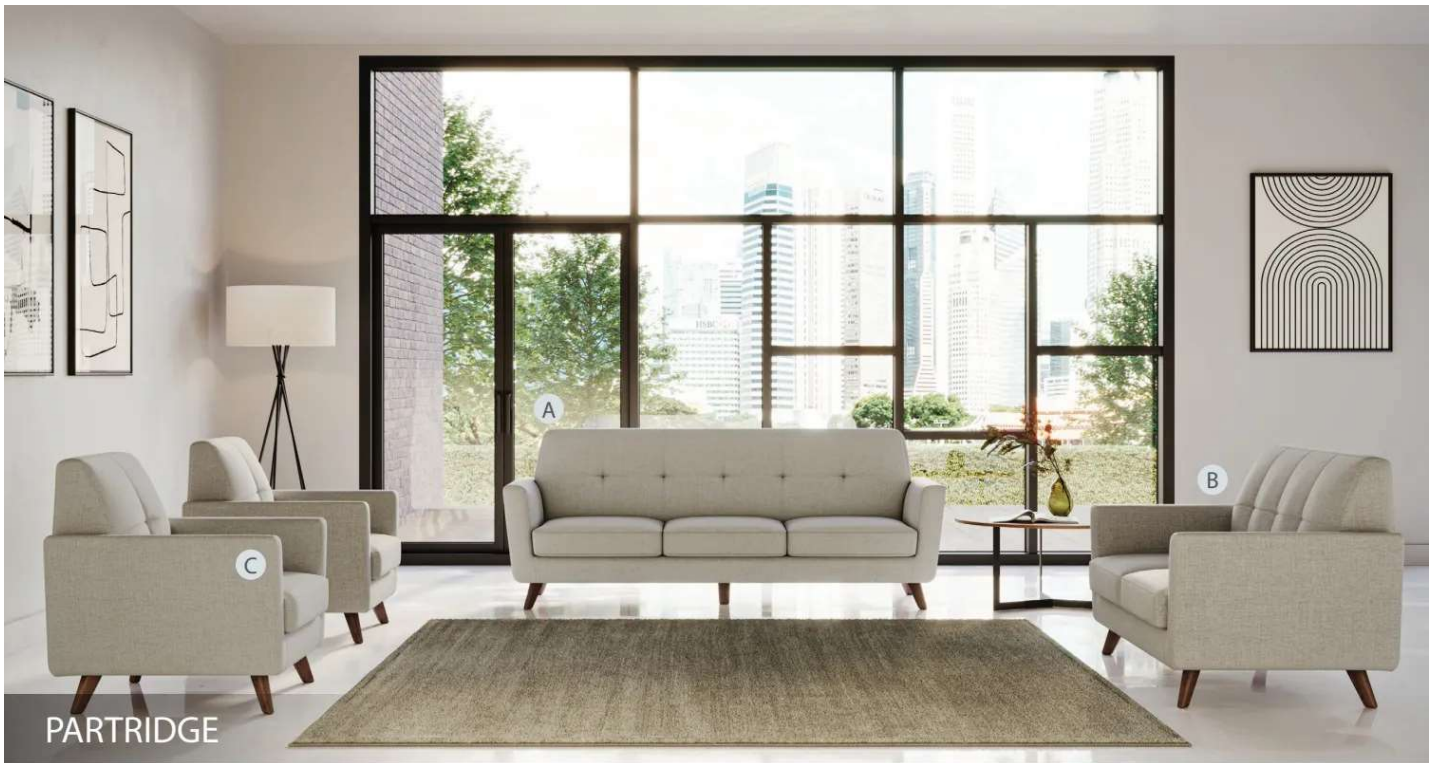

PARTRIDGE

**A Sofa w/Light Wood Legs**  
**50621F**  
 Overall: 79<sup>1</sup>/<sub>16</sub>"W x 30<sup>3</sup>/<sub>16</sub>"D x 32<sup>1</sup>/<sub>16</sub>"H  
 Seat: 70<sup>7</sup>/<sub>8</sub>"W x 18<sup>15</sup>/<sub>16</sub>"D x 17<sup>1</sup>/<sub>16</sub>"H  
 List: \$3,059.00

**B Loveseat w/Light Wood Legs**  
**50611F**  
 Overall: 58<sup>1</sup>/<sub>16</sub>"W x 30<sup>3</sup>/<sub>16</sub>"D x 32<sup>1</sup>/<sub>16</sub>"H  
 Seat: 47<sup>1</sup>/<sub>4</sub>"W x 18<sup>15</sup>/<sub>16</sub>"D x 17<sup>1</sup>/<sub>16</sub>"H  
 List: \$2,391.00

**C Club Chair w/Light Wood Legs**  
**50601F**  
 Overall: 35<sup>7</sup>/<sub>8</sub>"W x 30<sup>3</sup>/<sub>16</sub>"D x 32<sup>1</sup>/<sub>16</sub>"H  
 Seat: 23<sup>5</sup>/<sub>8</sub>"W x 18<sup>15</sup>/<sub>16</sub>"D x 17<sup>1</sup>/<sub>16</sub>"H  
 List: \$1,590.00

Note: 50601F can be shipped by a small package carrier. 

A



C



B



GR Gray Linen Fabric



LT Latte Fabric



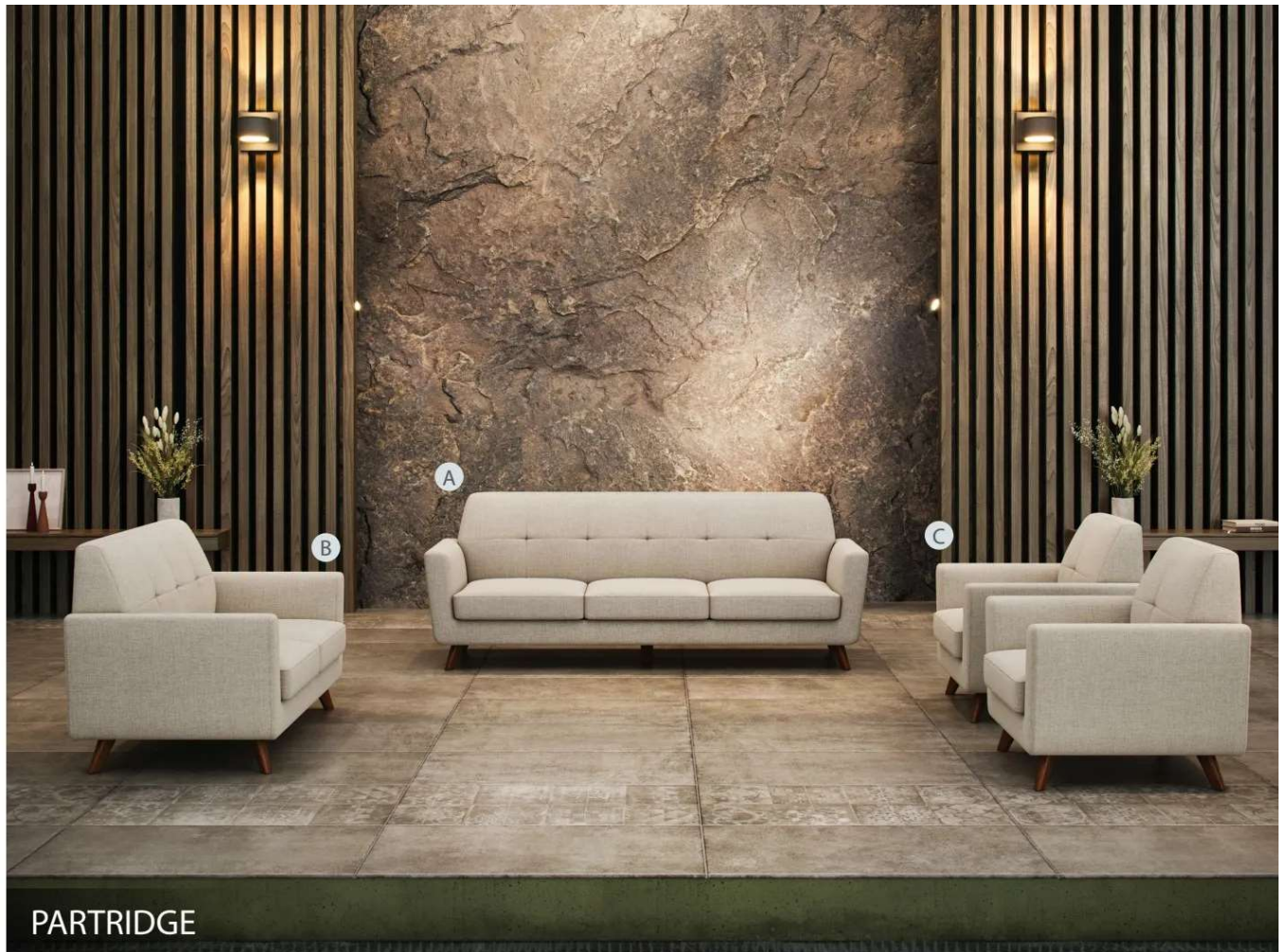

PARTRIDGE



*Pictured w/Palisades Tables*



GR Gray Linen Fabric



LT Latte Fabric



**NEW! MIRA**  
*Pictured w/Parallel Table*

**Wood Arm Upholstered  
 Lounge Chair  
 OSRL3001**

Overall: 29½"W x 32½"D x 35"H  
 Seat: 29½"W x 20½"D x 18½"H  
 List: \$1,980.00



PB Pebble Fabric



CR Charcoal Fabric



**CHAIR FEATURES**

*Bottom and back cushions are attached for a seamless design*



*Beautifully crafted, solid hardwood frame, legs and arms creates a contemporary and timeless style*



*Sinuous spring and web suspension with premium, high-density foam and fiber cushions*

*Textured weave fabric available in two fashionable colors*

*Fully Upholstered & Seamless Back*

*Ships Fully Assembled*



*Tapered Legs & Sloped Arms Offers A Contemporary Appeal*







**NEW! REMINGTON**

*Pictured w/OS Reception Laminate Table & Hairpin Legs*

**Wingback Upholstered  
Lounge Chair  
OSRL3002**

Overall: 28<sup>5</sup>/<sub>16</sub>"W x 33"D x 39"H  
 Seat: 28<sup>5</sup>/<sub>16</sub>"W x 33<sup>3</sup>/<sub>16</sub>"D x 39<sup>7</sup>/<sub>16</sub>"H  
 List: \$1,196.00



TF Toffee PU Leather



CR Charcoal PU Leather



**CHAIR FEATURES**

*Sleek and detailed back tufting with precision stitching*



*Durable and expertly crafted legs made from solid hardwood construction for long-lasting use*



*Sinuous spring and web suspension with premium, high-density foam and fiber cushions*

*Upholstered in a soft PU leather for a luxurious seating experience*



*Low-Rise Arms  
With A Round Wingback Design*



*Fully Upholstered Backside*



*Some Assembly Required*



## DOVER

Pictured w/OS Pedestal Tables

- A Designer Guest Chair**  
w/Wood Frame  
**1700F** (Fabric)  
**1700V** (Vinyl)  
Overall: 22"W x 25"D x 31¼"H  
Seat: 19½"W x 19½"D x 19"H  
List: \$574.00

*Note: Must order Frame & Upholstery Choice.*

- B Designer Half Arm**  
**1700SHA\***  
Overall: 20⅝"W x 1⅞"D x 24½"H  
List: \$211.00



### DESIGNER ARM FEATURES

\*Half arms are used with two chairs or more to create a multi-seat unit with no visible arm obstruction



\*\*Full arms are used with two chairs or more to create a multi-seat unit with visible arm obstruction

### ADDITIONAL PRODUCTS

- Designer Full Arm**  
**1700FA\*\***  
Overall: 20⅝"W x 1⅞"D x 25½"H  
List: \$245.00



#### Frame Finishes



CG Coastal Gray

ES Espresso



MW Modern Walnut

MH Mahogany



CH Cherry

#### Upholstery Colors



BK Black Fabric

BK Black  
Bonded Leather





## CHELSEA

*Pictured w/Parallel Tables*

**A Designer Guest Chair  
w/Wood Frame**  
**1600F (Fabric)**  
**1600V (Vinyl)**  
 Overall: 23½"W x 23½"D x 34"H  
 Seat: 20"W x 19½"D x 18½"H  
 List: \$600.00

*Note: Must order Frame & Upholstery Choice.*

**B Designer Full Arm  
1600FA\*\***  
 Overall: 22"W x 2"D x 26½"H  
 List: \$259.00



### DESIGNER ARM FEATURES

*\*Half arms are used with two chairs or more to create a multi-seat unit with no visible arm obstruction*



*\*\*Full arms are used with two chairs or more to create a multi-seat unit with visible arm obstruction*

## ADDITIONAL PRODUCTS

**Designer Half Arm  
1600SHA\***  
 Overall: 22"W x 1½"D x 24½"H  
 List: \$222.00



### Frame Finishes



CG Coastal Gray

ES Espresso



MW Modern Walnut

MH Mahogany



CH Cherry

### Upholstery Colors



BK Black Fabric

BK Black  
Bonded Leather

# BOWERY

From boardrooms and office rooms to dining rooms and healthcare, the Bowery is designed for comfort and durability. Crafted using solid exposed wood and full suspension, our guest seating can provide comfort and style.



**A Retro Style Guest Chair w/Wood Legs**  
**6909F** (Fabric w/Black Wood Legs)  
**6909V** (Vinyl w/Mahogany Wood Legs)  
 Overall: 24½"W x 25½"D x 35½"H  
 Seat: 19½"W x 20"D x 19"H  
 List: \$669.00

**B Barrel Back Guest Chair w/Black Wood Legs**  
**5209F** (Fabric)  
**5209V** (Vinyl)  
 Overall: 25½"W x 29"D x 28"H  
 Seat: 25½"W x 21"D x 19"H  
 List: \$884.00



*Beautifully Rounded & Fully Upholstered Backside*

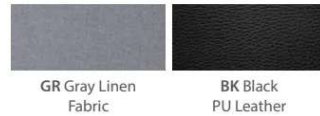

Note: Bowery chairs on this page can be shipped by a small package carrier.



## SPENCER



**Guest Chair w/Mahogany Frame  
1240V**

Overall: 26"W x 28"D x 36"H  
Seat: 21"W x 20½"D x 19"H  
List: \$669.00



**BK Black**  
Leather Soft Vinyl

This product is part of a complete collection.  
See Page 207



Note: Spencer chair on this page can be shipped by a small package carrier. 

## ADLEY



**Guest Chair w/Light Wood Legs  
05AD2JMGV**

Overall: 26¼"W x 26⅝"D x 31¼"H  
Seat: 20½"W x 19¾"D x 18½"H  
List: \$721.00

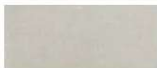

**CE Cream Vinyl**



*Exposed Back Cushion To Help Prevent Heat &  
Moisture Build Up With Padded Armrests*



### CHAIR FEATURES

*Textured feel that looks like linen despite being vinyl upholstery*



*Boxed arm design with attractive light wood legs creates a contemporary feel perfect for your office or home*

Note: Adley on this page can be shipped by a small package carrier. 

## BOLSTER



**Mid Back Swivel Chair  
w/5 Star Chrome Base  
12887F**

Overall: 29<sup>3</sup>/<sub>16</sub>"W x 28<sup>3</sup>/<sub>16</sub>"D x 33<sup>7</sup>/<sub>16</sub>-37<sup>1</sup>/<sub>16</sub>"H  
Seat: 17<sup>3</sup>/<sub>4</sub>"W x 18<sup>1</sup>/<sub>16</sub>"D x 18<sup>1</sup>/<sub>8</sub>-21<sup>1</sup>/<sub>16</sub>"H  
List: \$960.00

*Functions: Adjustable Seat Height,  
360 Degree Swivel, Tilt Tension, Tilt-Lock*



**Mid Back Guest Chair  
w/Light Wood Leg Base  
12881F**

Overall: 29<sup>3</sup>/<sub>16</sub>"W x 26<sup>13</sup>/<sub>16</sub>"D x 35<sup>1</sup>/<sub>16</sub>"H  
Seat: 18<sup>1</sup>/<sub>2</sub>"W x 18<sup>1</sup>/<sub>16</sub>"D x 19<sup>9</sup>/<sub>16</sub>"H  
List: \$907.00

Note: Bolster can be shipped by a small package carrier. 



**Mid Back Guest Chair  
w/Black Metal Sled Base  
12885F**

Overall: 29<sup>3</sup>/<sub>16</sub>"W x 26<sup>5</sup>/<sub>16</sub>"D x 35<sup>1</sup>/<sub>16</sub>"H  
Seat: 17<sup>3</sup>/<sub>4</sub>"W x 18<sup>1</sup>/<sub>16</sub>"D x 19<sup>9</sup>/<sub>16</sub>"H  
List: \$810.00



GR Gray Linen Fabric

## KINSLEY



**Modern Guest Chair  
w/Black Metal Legs  
05KI25MGF**

Overall: 23<sup>1</sup>/<sub>4</sub>"W x 24<sup>3</sup>/<sub>16</sub>"D x 31<sup>1</sup>/<sub>8</sub>"H  
Seat: 20<sup>1</sup>/<sub>2</sub>"W x 18<sup>1</sup>/<sub>8</sub>"D x 18<sup>1</sup>/<sub>8</sub>"H  
List: \$715.00



GR Gray Linen Fabric

Note: Kinsley can be shipped by a small package carrier. 

## ROUND



**Swivel Club Chair  
3385V**

Overall: 31"W x 28<sup>1</sup>/<sub>2</sub>"D x 29<sup>3</sup>/<sub>4</sub>"H  
Seat: 21<sup>1</sup>/<sub>4</sub>"W x 21<sup>1</sup>/<sub>4</sub>"D x 18<sup>3</sup>/<sub>4</sub>"H  
List: \$1,380.00



BK Black PU Leather



### UNIQUE FEATURES

*Sturdy, durable black metal base with a complete 360 Degree Swivel complements the contemporary, timeless look*



## TATE



**Guest Chair w/Arms & Black Frame  
18925V**  
Overall: 25 $\frac{1}{16}$ "W x 23 $\frac{7}{16}$ "D x 35 $\frac{1}{2}$ "H  
Seat: 20"W x 20 $\frac{7}{16}$ "D x 18 $\frac{1}{8}$ "H  
List: \$588.00



BK Black PU Leather

Note: Tate can be shipped by a small package carrier. 

## EBONY



**Guest Chair w/Black Frame  
769A**  
Overall: 22 $\frac{7}{16}$ "W x 25 $\frac{3}{16}$ "D x 34 $\frac{7}{16}$ "H  
Seat: 20 $\frac{1}{2}$ "W x 19"D x 18 $\frac{1}{16}$ "H  
List: \$469.00



BK Black Vinyl

Note: Ebony can be shipped by a small package carrier. 

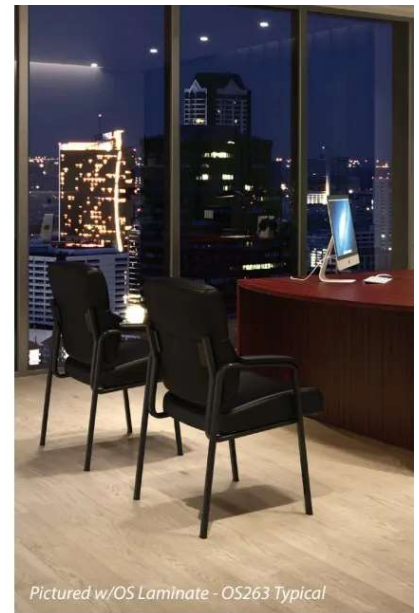

*Pictured w/OS Laminate - OS263 Typical*



*Wall Saver  
Back Leg Design*

## NEW! INTERCHANGEABLE



*Black Mesh Back  
(Shown Without Arms)*



*Gray Mesh Back  
w/Optional "Z" Armrests  
(Shown Using Included Arms)*



*Sled base with black floor glides to prevent  
scratching or marring of floor surfaces*

This product is part of a complete collection.  
See Pages 178-179

**Gray or Black Mesh Back, Armless  
Guest Chair w/Sled Base**  
**6569MGF** (Gray Mesh Back)  
**6569MBF** (Black Mesh Back)  
Overall: 25 $\frac{1}{16}$ "W x 19 $\frac{1}{2}$ "D x 39 $\frac{3}{8}$ "H  
Seat: 19 $\frac{3}{16}$ "W x 19 $\frac{7}{16}$ "D x 18 $\frac{3}{4}$ "H  
List: \$610.00



BK Black Fabric Seat



### CHAIR FEATURES

*Optional "Z" padded armrests are included  
with both colors - create a guest chair with  
or without arms*



*Guest chair provides back lumbar support  
to give your guest the comfort they  
deserve while sitting*



## NEW! JOLA

*Pictured w/NEW! OSTYP331 Typical*

### Fabric Guest Chair w/Black Metal Base OSGS4001

Overall: 22 $\frac{1}{16}$ "W x 19 $\frac{3}{4}$ "D x 30 $\frac{3}{4}$ "H

Seat: 19 $\frac{3}{4}$ "W x 17 $\frac{3}{4}$ "D x 30 $\frac{1}{16}$ "H

List: \$1,560.00 ctn.

*Note: Priced and sold as (2) per carton.*



### UNIQUE FEATURES

*Unique, cross-stitching detail adds high-end appeal for your gathering or collaboration areas*



CN Crimson Fabric



AP Asphalt Fabric

*Guest chairs include black floor glides to prevent scratching or marring of floor surfaces*



### MATCHING STOOL

*Bar Height - See Page 166*







## WILLOW

*Pictured w/NEW! OSTYP330 Typical & Tribeca Seating*

- A Mid Back Guest Chair w/Black Metal Sled Base 06WI2WMGSBF**  
 Overall: 19¾"W x 22"D x 31¾"H  
 Seat: 19¾"W x 16½"D x 18½"H  
 List: \$585.00 ea.  
*Note: Priced as each & sold in increments of (2).*

- B Mid Back Guest Chair w/Black Metal Leg Base 06WI2WMGPLF**  
 Overall: 19¾"W x 22"D x 31¾"H  
 Seat: 19¾"W x 16½"D x 18½"H  
 List: \$585.00 ea.  
*Note: Priced as each & sold in increments of (2).*



Note: Willow on this page can be shipped by a small package carrier. 📦



### MATCHING STOOL

*Café Height - See Page 167*





Pictured w/OS Pedestal Tables

## VALUE

**A Sled Base Fabric Guest Chair w/Black Frame 2708F**  
 Overall: 24"W x 25"D x 34½"H  
 Seat: 20"W x 19"D x 18"H  
 List: \$368.00

**Armless, Sled Base Fabric Guest Chair w/Black Frame 2709F**  
 Overall: 24"W x 25"D x 34½"H  
 Seat: 20"W x 19"D x 18"H  
 List: \$339.00

**B Sled Base Vinyl Guest Chair w/Black Frame 2748A**  
 Overall: 24"W x 25"D x 34½"H  
 Seat: 20"W x 19"D x 18"H  
 List: \$399.00



Note: Value chairs on this page can be shipped by a small package carrier.

## MERIT

**A Sled Base Guest Chair w/Arms & Black Frame 315V**  
 Overall: 23"W x 24½"D x 34"H  
 Seat: 20"W x 20"D x 18½"H  
 List: \$359.00

**B Armless, Sled Base Guest Chair w/Black Frame 314V**  
 Overall: 23"W x 24½"D x 34"H  
 Seat: 20"W x 20"D x 18½"H  
 List: \$343.00



BK Black Leather Soft Vinyl

Note: Merit chairs on this page can be shipped by a small package carrier.







Pictured w/Matching Blow Mold Folding Tables - See Page 132

## BLOW MOLD FOLDING CHAIR



**Plastic Folding Chair  
w/Gray Frame  
FBM03\***

List: \$596.00 ctn.

Note: FBM03 Priced (4) Per Carton.



GR Gray Plastic



**Black Folding Chair Cart  
FCDRA51**

(Holds up to (30) FBM03  
or (72) 1601 & 1631)

67"W x 31"D x 70"H  
List: \$1,138.00



### CHAIR FEATURES

Hand indentation for easy portability on the back of the chair



Strong, durable frame can hold up to 275 lbs. of weight and folds for easy storage

## STEEL FOLDING CHAIRS

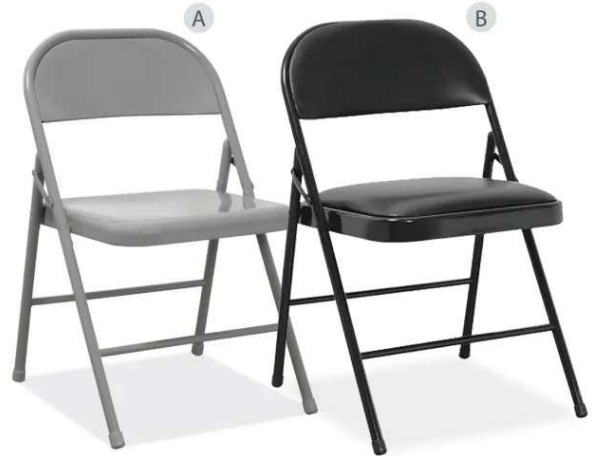

**A All Steel Folding Chair  
1601\***

List: \$365.00 ctn.

Note: 1601 & 1631 Priced (4) Per Carton.

**B Steel Folding Chair  
w/Padded Seat & Back  
1631V\***

List: \$467.00 ctn.



BK Black Steel



GR Gray Steel



BK Black Vinyl  
(1631 Only)

Note: FBM03, 1601 & 1631 can be shipped by a small package carrier. 

\*Note: Chairs cannot be sold in singles.

# REESE



**A**  
**STACKS**  
**16**  
H I G H  
 Weight Capacity  
 300 LBS



**B**  
**STACKS**  
**16**  
H I G H  
 Weight Capacity  
 300 LBS



**STACKS**  
**12**  
H I G H  
 ON DOLLY

**A Square Back Stacker w/Black Stipple Steel Frame 10RE1SWMSV**  
**Weight Capacity: 300 LBS**  
 Overall: 17"W x 21"D x 37"H  
 Seat: 16"W x 16"D x 18"H  
 List: \$221.00

**B High Back Stacker Banquet Chair w/Black Stipple Steel Frame 10BA1WMSF**  
**Weight Capacity: 300 LBS**  
 Overall: 17"W x 21"D x 37"H  
 Seat: 16"W x 16"D x 18"H  
 List: \$228.00

**C Black Chair Dolly 10STKDOLLY**  
*(Holds up (12) Chairs Only)*  
 Overall: 20"W x 32½"D x 48"H  
 List: \$493.00

Note: 10STKDOLLY can be shipped by a small package carrier. 

## FEATURES

- High density, 2" thick seat cushion
- Nylon rocker glides and stack bumpers
- 16-Gauge steel tubing frame
- Baked powder epoxy finish



**BK Black Vinyl**  
 (10RE1SWMSV)  
 (Chair A Only)



**BK Black Fabric**  
 (10BA1WMSF)  
 (Chair B Only)



**Black Stipple Frame**

Items in this collection come fully assembled.







## AERO

Pictured w/Optional Casters & OS Training Tables



**A** Armless Guest Chair w/Black Seat & Titanium Frame  
**3220TGF**

Overall: 20½"W x 23¼"D x 33½"H  
Seat: 18"W x 19¼"D x 18½"H  
List: \$347.00

STACKS  
4  
↑



**B** Guest Chair w/Arms, Black Seat & Titanium Frame  
**3204TGF**

Overall: 23¾"W x 23¼"D x 33½"H  
Seat: 18"W x 19¼"D x 18½"H  
List: \$374.00

### OPTIONAL CASTERS

(For 3220TG & 3204TG)

#### Casters (Set of 4)

**2700CASTERS**

List: \$58.00

(BK Black)



BK Black Fabric

Note: 2700CASTERS can be shipped by a small package carrier. 



## MARIO

### A All Charcoal Stackable Student Desk w/Chrome Frame 6080

26<sup>13</sup>/<sub>16</sub>"W x 22<sup>1</sup>/<sub>16</sub>"D x 28<sup>1</sup>/<sub>4</sub>"H  
List: \$417.00

### B All Charcoal Armless Stackable Student Chair w/Chrome Frame 6070

Overall: 20<sup>3</sup>/<sub>16</sub>"W x 20<sup>1</sup>/<sub>2</sub>"D x 31<sup>1</sup>/<sub>16</sub>"H  
Seat: 17<sup>1</sup>/<sub>16</sub>"W x 16<sup>3</sup>/<sub>16</sub>"D x 17<sup>1</sup>/<sub>16</sub>"H  
List: \$278.00



### UNIQUE FEATURES

Student desks come with a pencil holder, modesty panel and slide-out hook on both sides for your personal bags

Note: Chairs & desks include ganging brackets.

STACKS  
H  
I  
G  
H  
6



CR Charcoal Plastic  
Back & Seat

Most items in this collection  
come fully assembled.

Note: Products A, B & C on this page can be shipped by a small package carrier. 📦

### ADDITIONAL PRODUCTS



STACKS  
H  
I  
G  
H  
12  
ON DOLLY

### C Silver Desk Dolly 6080DOLLYSI

(For 6080 Desks)  
32<sup>19</sup>/<sub>16</sub>"W x 27<sup>7</sup>/<sub>16</sub>"D x 22<sup>7</sup>/<sub>16</sub>"H  
List: \$417.00

### D Silver Chair Dolly 6070DOLLYSI

(For 6070 Chairs)  
17"W x 30"D x 24<sup>1</sup>/<sub>4</sub>"H  
List: \$290.00



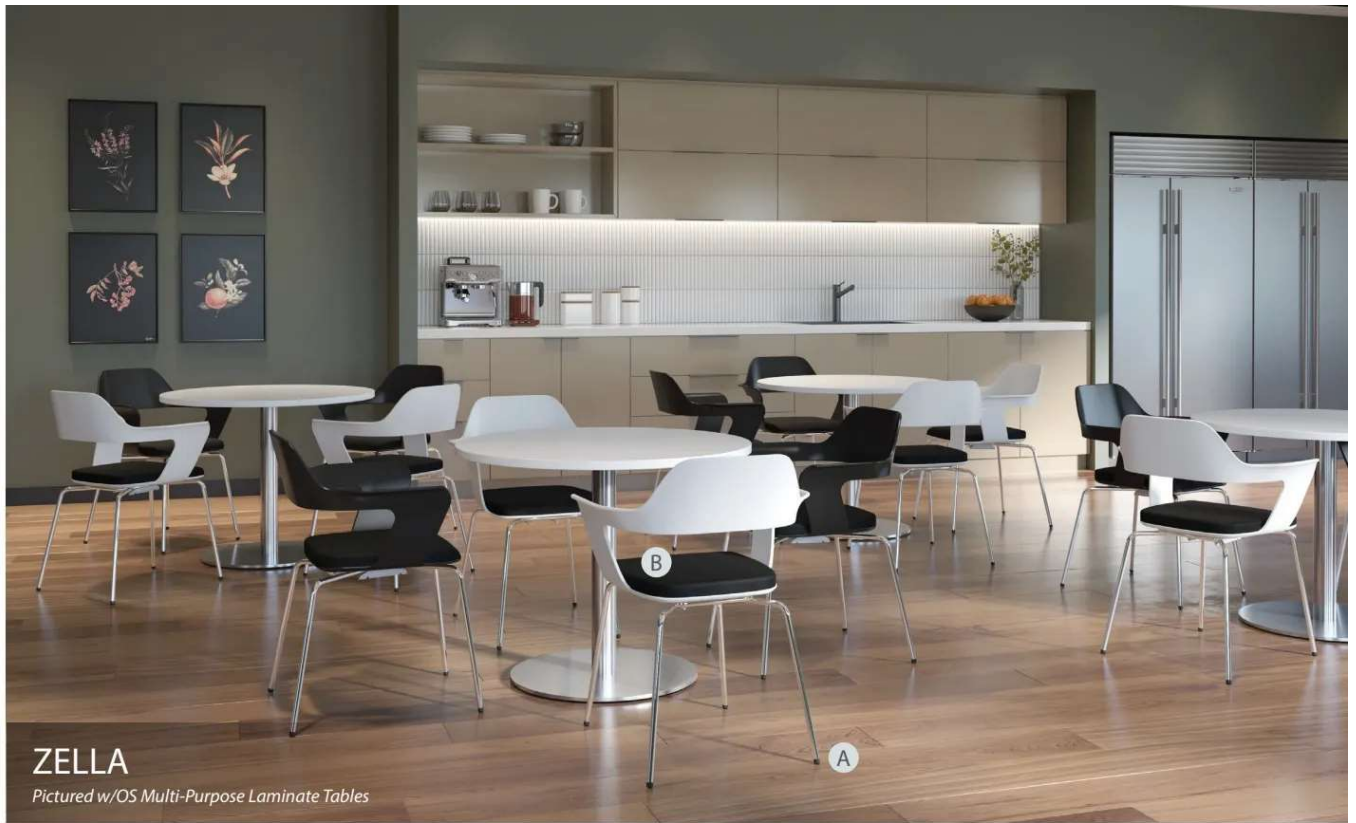

## ZELLA

Pictured w/OS Multi-Purpose Laminate Tables

### A Stackable Chair w/Chrome Frame 6054

Overall: 23¾"W x 22¼"D x 31¼"H

Seat: 16"W x 16½"D x 17½"H

List: \$404.00



BK Black Plastic



WH White Plastic

Note: Zella on this page can be shipped by a small package carrier. 

### B Optional Top Cushion 6054CUSHF

Overall: 15¾"W x 16½"D x 1½"H

List: \$106.00



### UNIQUE FEATURES

No tools are necessary for the optional seat cushion, attaches with double-faced tape

#### Top Cushion Upholstery



BK Black Fabric



CR Charcoal Fabric



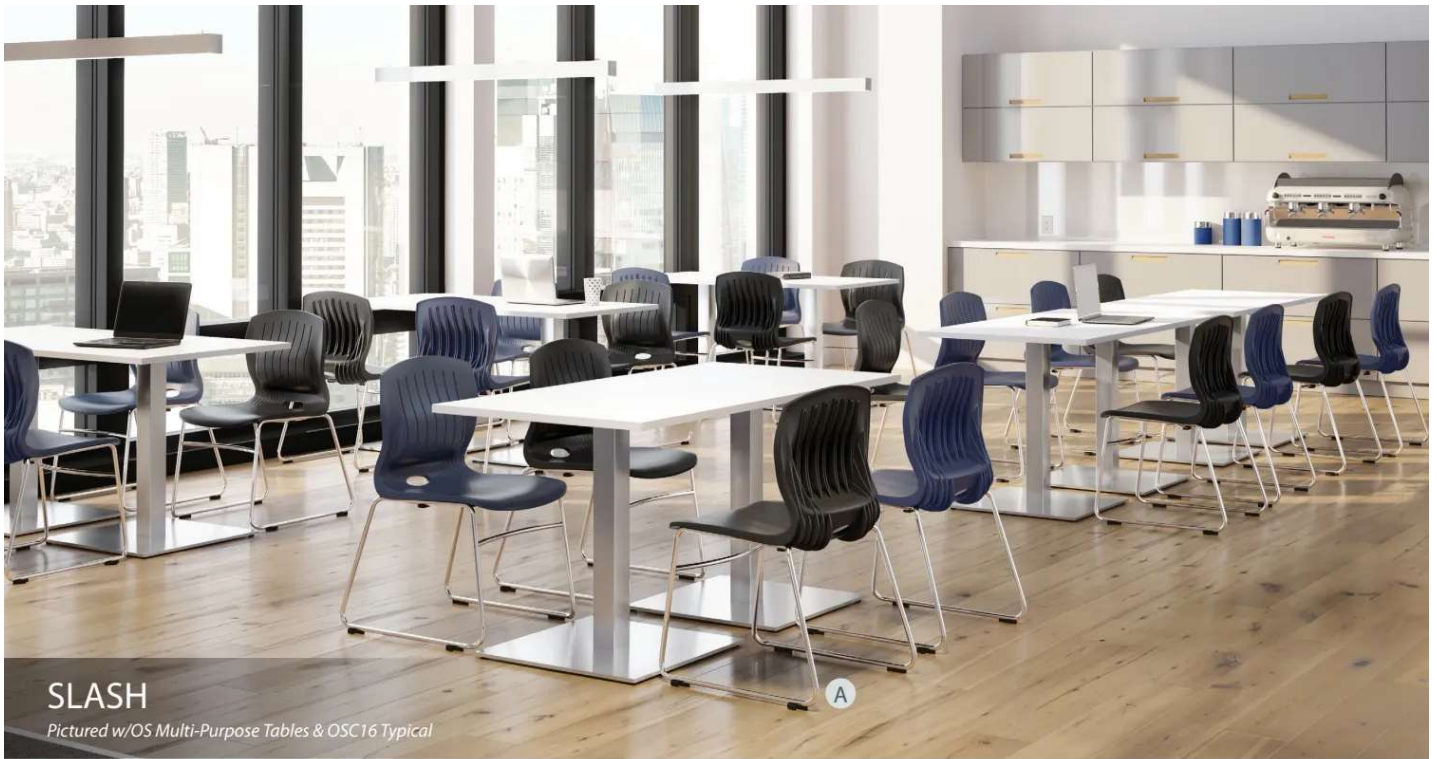

## SLASH

Pictured w/OS Multi-Purpose Tables & OSC16 Typical

**A Armless Stacking Guest Chair w/Chrome Sled Base 3040SB**  
 Overall: 21"W x 21¾"D x 32¼"H  
 Seat: 18"W x 16"D x 16¾"H  
 List: \$233.00

**B Armless Stacking Guest Chair w/Chrome Frame 3040PL**  
 Overall: 21"W x 21¾"D x 32¾"H  
 Seat: 18"W x 16"D x 17"H  
 List: \$233.00



BK Black Plastic

NV Navy Plastic



## TOWER

**A Stackable Guest Chair w/Chrome Frame SC1400**  
 Overall: 18½"W x 18"D x 32½"H  
 Seat: 18½"W x 18"D x 18"H  
 List: \$236.00

**B Black Chair Dolly D100**  
 (For SC1400)  
 22"W x 23"D x 19"H  
 List: \$270.00



BK Black Plastic

Most items in this collection come fully assembled.



Note: SC1400 on this page can be shipped by a small package carrier.





## STACKED SEATING

Pictured w/OS Multi-Purpose Tables & Rise Seating - NEW! OSTYP314 Typical

### A Stackable Guest Chair w/Arms & Chrome Frame (Black Only)

3081

Overall: 24½"W x 22¾"D x 31"H

Seat: 18"W x 16¾"D x 17¾"H

List: \$238.00

Note: 3081 *does not* gang together.



STACKS  
12↑  
BOTH CHAIRS

### B Armless Stackable Guest Chair w/Chrome Frame

3080

Overall: 20¾"W x 22¾"D x 32¼"H

Seat: 18"W x 16¾"D x 17¾"H

List: \$188.00

### C Black Chair Dolly

3080DOLLYBK

(For 3080 & 3081)

22¾"W x 25"D x 14"H

List: \$178.00



STACKS  
16↑  
ON DOLLY

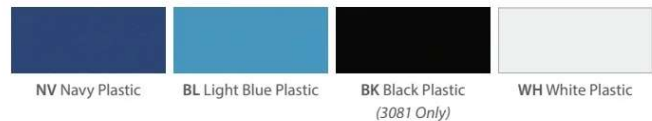

NV Navy Plastic

BL Light Blue Plastic

BK Black Plastic  
(3081 Only)

WH White Plastic

Most Items in this collection come fully assembled.

Note: 3080DOLLY on this page can be shipped by a small package carrier. 📦

# PARSON

**A Micro Mesh Back Guest Chair w/Arms & Black Frame**  
 Overall: 22½"W x 23¼"D x 33½"H  
 Seat: 18½"W x 18½"D x 18¼"H  
**3128GNSF** (Fabric) List: \$435.00  
**3128GNSA** (Vinyl) List: \$487.00

**B Armless Micro Mesh Back Guest Chair w/Black Frame**  
 Overall: 22½"W x 23¼"D x 33½"H  
 Seat: 18½"W x 18½"D x 18¼"H  
**3129GNSF** (Fabric) List: \$427.00  
**3129GNSA** (Vinyl) List: \$479.00



*Pictured w/Optional Casters - OSC31 Typical*



## FEATURES

- Ergonomic design with an eye catching look
- Optimal comfort through ideal seating dimensions
- Optional casters provides mobility when you need it

**OPTIONAL CASTERS**  
 (For 3128GNS & 3129GNS)  
**Casters (Set of 4)**  
**2700CASTERS**  
 List: \$58.00  
 (BK Black)



Note: Parson on this page can be shipped by a small package carrier.

# CROSSWAY

**A Mesh Back Guest Chair w/Arms & Black Frame**  
 Overall: 24"W x 24"D x 33"H  
 Seat: 18"W x 18"D x 19½"H  
**2029F** (Fabric Seat) List: \$285.00  
**2029V** (Vinyl Seat) List: \$290.00

**B Mesh Back Armless Guest Chair w/Black Frame**  
 Overall: 24"W x 24"D x 33"H  
 Seat: 18"W x 18"D x 19½"H  
**2028F** (Fabric Seat) List: \$270.00  
**2028V** (Vinyl Seat) List: \$275.00

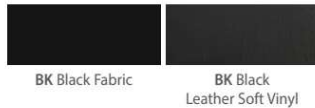

Note: Crossway on this page can be shipped by a small package carrier.

This product is part of a complete collection.  
 See Page 191



*Shown w/Black Fabric*

*Shown w/Black Leather Soft Vinyl*



# CARSON



STACKS  
4  
↑

**Mesh Back Guest Chair w/Black Frame  
18929F**  
Overall: 25"W x 23¼"D x 33¼"H  
Seat: 20"W x 20½"D x 19⅝"H  
List: \$559.00

**OPTIONAL  
CASTERS**  
*(For 18929 Only)*  
**Casters (Set of 4)  
18929CASTERS**  
List: \$64.00  
*(BK Black)*



BK Black Fabric



Shown w/Optional Casters

Note: Carson chair can be shipped by a small package carrier. 📦

# LEVY



**Stacking Guest Chair  
w/Arms & Black Frame  
1022V**  
Overall: 23½"W x 23"D x 30½"H  
Seat: 18"W x 18"D x 18"H  
List: \$236.00



BK Black  
Leather Soft Vinyl



STACKS  
4  
↑

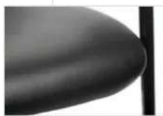

### UNIQUE FEATURES

*Designed with a unique waterfall front seat cushion that helps to prevent leg fatigue for your guests while sitting*

Note: Levy chair on this page can be shipped by a small package carrier. 📦

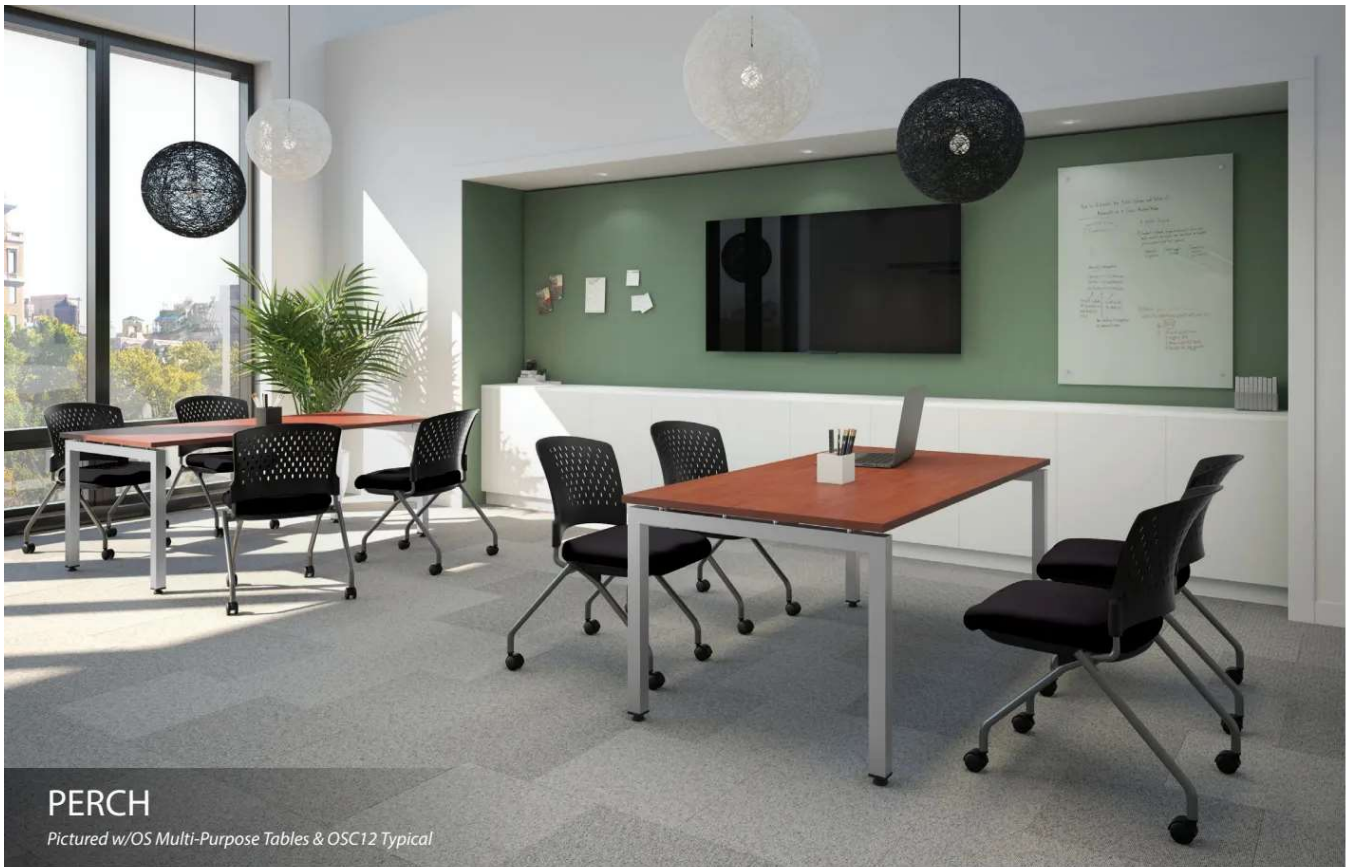

## PERCH

*Pictured w/OS Multi-Purpose Tables & OSC12 Typical*

**A Armless Nesting Chair  
w/Casters & Titanium Frame**  
Overall: 22½"W x 21½"D x 34½"H  
Seat: 18½"W x 19"D x 19"H  
**3274TNSF** (Fabric) List: \$483.00  
**3274TNSA** (Vinyl) List: \$522.00

**B Nesting Chair w/Arms, Casters  
& Titanium Frame**  
Overall: 24"W x 21½"D x 34½"H  
Seat: 18½"W x 19"D x 19"H  
**3294TNSF** (Fabric) List: \$524.00  
**3294TNSA** (Vinyl) List: \$563.00



*Nesting*

Note: Perch can be shipped by a small package carrier.





## JULEP

*Pictured w/OS Training Tables*

### A Nesting Chair w/Arms, Casters & Black Frame

**5494NSF**

Overall: 24½"W x 23¼"D x 36"H

Seat: 17¾"W x 18¼"D x 19"H

List: \$505.00

### B Armless Nesting Chair w/Casters & Black Frame

**5474NSF**

Overall: 22½"W x 23¼"D x 36"H

Seat: 17¾"W x 18¼"D x 19"H

List: \$461.00



BK Black Fabric

GR Cool Gray Fabric

BL Celestial Blue Fabric



### CHAIR DESIGN

*Flex back design allows user to lean back in this chair*



Note: Julep can be shipped by a small package carrier. 

## TRIUMPH

### Armless Nesting Flex Back Chair w/Casters & Black Frame

**90094NSF**

Overall: 23⅞"W x 21⅝"D x 33⅞"H

Seat: 17"W x 17"D x 19"H

List: \$858.00



*Pictured w/OS Multi-Purpose Glass Table & Optional Armrests*



*Nesting*



BK Black Fabric

### OPTIONAL ARM RESTS

*(For 90094NS Only)*

#### Plastic Arm Rest

(Set of 2)

**90094A**

List: \$87.00

*(BK Black)*



Note: 90094NSF on this page can be shipped by a small package carrier. 



**NEW! JOLA**

*Pictured w/NEW! Sofia Collaboration Table w/NEW! American Elm Top*

**Bar Height Fabric Stool  
w/Black Metal Base  
OSST7001**

Overall: 22 $\frac{1}{8}$ "W x 20 $\frac{1}{2}$ "D x 42 $\frac{1}{8}$ "H

Seat: 19 $\frac{3}{4}$ "W x 17 $\frac{3}{4}$ "D x 18 $\frac{1}{8}$ "H

List: \$1,720.00 ctn.

*Note: Priced and sold as (2) per carton.*



CN Crimson Fabric



AP Asphalt Fabric





**CHAIR FEATURES**

*Black metal base offers stability and durability with a built-in footrest*



*Contemporary design with a unique pass-through seat that provides easy cleaning*



**MATCHING  
GUEST CHAIR**

*This product is part of a complete collection.  
See Page 152*





**WILLOW**

*Pictured w/OS Multi-Purpose Tables - NEW! OSTYP315 Typical*

**Café Height Bistro Stool  
w/Black Steel Base**

**06W12JLSF**

Overall: 21<sup>1</sup>/<sub>16</sub>"W x 22<sup>1</sup>/<sub>16</sub>"D x 38"H

Seat: 19<sup>1</sup>/<sub>16</sub>"W x 16<sup>3</sup>/<sub>16</sub>"D x 30<sup>3</sup>/<sub>16</sub>"H

List: \$597.00

*Note: Priced as each & sold in increments of (2).*



BL Blue Fabric



GR Gray Fabric

*Note: Willow can be shipped by a small package carrier.*



**MATCHING  
GUEST CHAIR**

*This product is part of a complete collection.  
See Page 153*

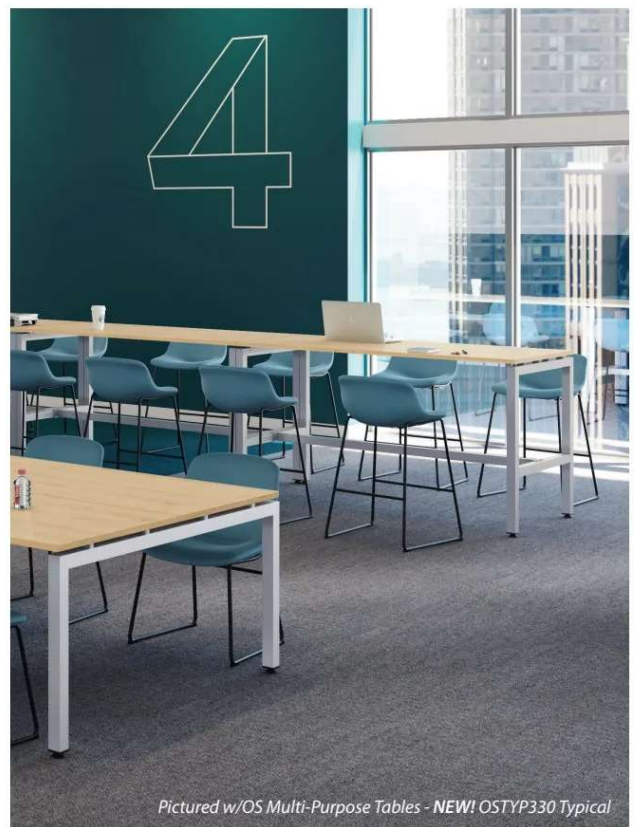

*Pictured w/OS Multi-Purpose Tables - NEW! OSTYP330 Typical*



## COLOR STACK

Pictured w/OS Multi-Purpose Tables

### A Mesh Stool w/Painted Frame 629M

Overall: 22<sup>3</sup>/<sub>8</sub>"W x 23<sup>5</sup>/<sub>8</sub>"D x 44<sup>1</sup>/<sub>8</sub>"H  
Seat: 17<sup>1</sup>/<sub>8</sub>"W x 19<sup>3</sup>/<sub>8</sub>"D x 30<sup>7</sup>/<sub>8</sub>"H  
List: \$557.00

### B Mesh Stack Chair w/Painted Frame 628M

Overall: 20<sup>7</sup>/<sub>8</sub>"W x 21<sup>5</sup>/<sub>8</sub>"D x 32<sup>1</sup>/<sub>2</sub>"H  
Seat: 17<sup>1</sup>/<sub>8</sub>"W x 19<sup>3</sup>/<sub>8</sub>"D x 18<sup>1</sup>/<sub>8</sub>"H  
List: \$417.00

Note: 628M on this page can be shipped by a small package carrier. 



#### UNIQUE FEATURES

*Soft mesh backrest and seat provides tension, balance, flexibility & air permeability with a painted matching metal frame for durability*



*Both chairs include clear floor glides on the bottom to protect your floors from surface scratches*



Stacks to 4 High - 628M Only



BK Black Mesh



RD Red Mesh





## RISE STOOL

Pictured w/OS Standing Tables - See Page 35

### Polyurethane Stool w/Footrest & Chrome Base 3085STOOL

Overall: 20"W x 23"D x 43¾"H

Seat: 18"W x 17"D x 29"H

List: \$357.00

Note: 3085STOOL *does not* stack.



NV Navy Plastic

BL Light Blue Plastic



BK Black Plastic

WH White Plastic



29"H



Sleek & Thin Profile



Pairs well with OS Multi-Purpose Tables - See Page 120



Pairs well with Stacked Seating - See Page 161

## NEW! OSLO

### Mesh Back Stool w/Arms & Black Frame 607MMF

Overall: 24 $\frac{5}{8}$ "W x 24 $\frac{1}{6}$ "D x 44 $\frac{1}{6}$ "H  
Seat: 19 $\frac{1}{4}$ "W x 17 $\frac{3}{8}$ "D x 29"H  
List: \$520.00  
Note: 607MMF *does not* stack.

#### CHAIR DESIGN

Durable, mesh back promotes airflow while providing optimal lumbar support



Sturdy Metal Frame with Foot Support



Powder-Coated Aluminum Frame

### MATCHING CHAIR FAMILY

Guest Chair - See Pages 176-177



BK Black Fabric w/Black Frame

## SPICE

### Armless Mesh Back Task Stool w/Matte Black Footring & Titanium Steel Base

Overall: 25 $\frac{1}{2}$ "W x 25 $\frac{1}{2}$ "D x 42-51 $\frac{1}{4}$ "H  
Seat: 20 $\frac{1}{2}$ "W x 19 $\frac{1}{2}$ "D x 24-33 $\frac{3}{4}$ "H  
7851NSF (Fabric Seats) List: \$691.00  
7851NSA (AM Vinyl & Fabric Seats) List: \$691.00  
7851NSM (Mesh Seat) List: \$768.00  
7851NSL (Leather Seat) List: \$790.00

Functions: Adjustable Seat Height, 360 Degree Swivel, Tilt-Tension, Tilt-Lock, Height & Width Adjustable Arms (Optional)



Seat Height: 24-33 $\frac{3}{4}$ "H

#### OPTIONAL ARMS

(For 7851NS)

#### Adjustable Arm Kit 311AK

List: \$157.00 (BK Black)



This product is part of a complete collection. See Page 189



Shown w/Optional Arm Kit

Note: Spice can be shipped by a small package carrier.

#### OfficeSource® Spice Seat Type Options - Build Your Custom Chair



Note: When selecting chair, please choose seat cushion.



# COOLMESH PRO



Seat Height:  
25 - 33½"H

## Mesh Back Task Stool w/Adjustable Arms, Footring & Titanium Steel Base

Overall: 25½"W x 25¾"D x 41-49½"H

Seat: 20½"W x 19½"D x 25-33½"H

8051ANSF (Fabric Seats) List: \$934.00

8051ANSA (AM Vinyl & Fabric Seats) List: \$934.00

8051ANSM (Mesh Seat) List: \$1,011.00

8051ANSL (Leather Seat) List: \$1,033.00

Functions: Adjustable Seat Height, 360 Degree Swivel, Ratchet Back, Height Adjustable Arms

This product is part of a complete collection. See Pages 182-183

Note: CoolMesh Pro can be shipped by a small package carrier.

### CHAIR DESIGN

Ratchet back with hard, durable frame provides long-lasting support

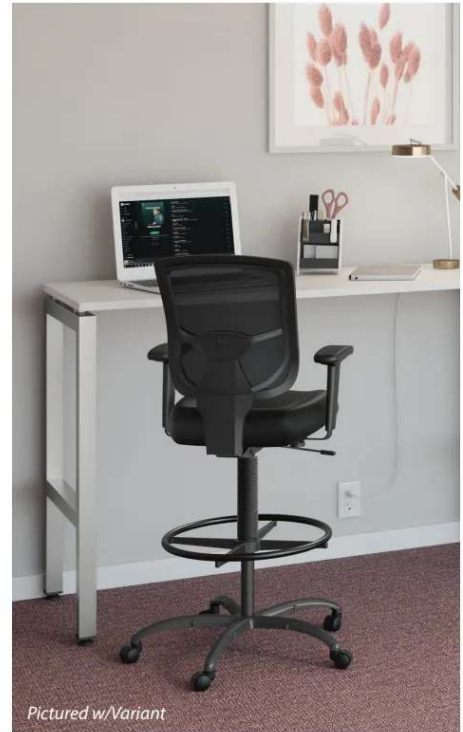

Pictured w/Variant



Shown w/Olive Green Antimicrobial Fabric Seat



Shown w/Black Leather Seat - Profile View



Shown w/Black Mesh Seat

### OfficeSource® CoolMesh Pro Seat Type Options - Build Your Custom Chair



BK Black Fabric



NV Navy Blue Fabric



BL Celestial Blue Fabric



GR Cool Gray Fabric



AS Ash Gray Antimicrobial Fabric



BK Black Antimicrobial PU Leather



BK Top Grain Leather



RD Red Fabric



OR Orange Fabric



CO Cobalt Blue Antimicrobial Fabric



OL Olive Green Antimicrobial Fabric



BK Mesh



NP Neptune Antimicrobial PU Leather

Note: When selecting chair, please choose seat cushion.

# TASK FORCE



Seamless Cushion Design

Seat Height: 26 1/2" - 30" H

## A Task Stool w/Footing & Chrome Base 6801FPFRA

Overall: 24 3/4"W x 27"D x 43"-46 1/2"H  
Seat: 19 3/4"W x 19"D x 26 1/2"-30"H  
List: \$852.00

Functions: Adjustable Seat Height, 360 Degree Swivel, Height Adjustable Arms

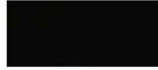

BK Black Antimicrobial Vinyl

## B Mid Back Task Chair w/Chrome Base 6801FPA

Overall: 24 3/4"W x 27"D x 36 3/4"-40 1/4"H  
Seat: 19 3/4"W x 19"D x 18 1/2"-22"H  
List: \$733.00

Functions: Adjustable Seat Height, 360 Degree Swivel, Height Adjustable Arms



BK Black Antimicrobial Vinyl



Matching Task Chair

Note: All items for Task & Effort can be shipped by a small package carrier. 📦

## TASK FORCE / EFFORT OPTIONS

### OPTIONAL GLIDES

(For 316FR & 6801FPFR)

#### Glides (Set of 5) NORGLIDES

List: \$49.00  
(BK Black)



### OPTIONAL CASTERS

(For 316FR & 6801FPFR)

#### Soft Caster Kit (Set of 5) NORCASTER

List: \$62.00  
(BK Black)



### OPTIONAL ARMS

(For 316FR Only)

#### Adjustable Arm Kit B909JARM

List: \$148.00  
(BK Black)



# EFFORT

## A Black Leather Armless Deluxe Posture Chair w/Footing & Black Base 316FRL

Overall: 25"W x 25"D x 44 1/2"-49 1/2"H  
Seat: 20"W x 18"D x 26 1/2"-31 1/2"H  
List: \$461.00

Functions: Adjustable Seat Height, Seat Depth Adjustment, 360 Degree Swivel



BK Black Bonded Leather

## B Black Leather Armless Deluxe Posture Chair w/Black Frame 316L

Overall: 25"W x 25"D x 35"-40"H  
Seat: 17 1/2"W x 16 1/2"D x 18 1/2"-23 1/2"H  
List: \$342.00

Functions: Adjustable Seat Height, Seat Depth Adjustment, 360 Degree Swivel



BK Black Bonded Leather



A

Seat Height: 26 1/2" - 31 1/2" H



B

Matching Task Chair



## MEDICAL STOOLS



Seat Height  
w/Footing:  
28 -34"H

Shown w/Optional Footring

### A Medical Stool w/Backrest & Polished Chrome Base 345FPA

Overall: 25"Dia x 33½-39½"H  
Seat: 16"Dia x 20½-26½"H  
List: \$443.00

Functions: Adjustable Seat Height, 360 Degree Swivel



Seat Height:  
20½ -26½"H

### B Medical Stool w/Polished Chrome Base 343FPA

Overall: 25"Dia x 20½-26½"H  
Seat: 16"Dia x 20½-26½"H  
List: \$371.00

Functions: Adjustable Seat Height, 360 Degree Swivel



Seat Height:  
20½ -26½"H



Seat Height  
w/Footing:  
28 -34"H

Shown w/Optional Footring



### OPTIONAL FOOTRING

(For 343FPA & 345FPA)

### Chrome Footring Kit FRKIT

List: \$119.00



BK Black  
Antimicrobial Vinyl

Note: 345FP & 343FP can be shipped by a small package carrier.

## BELL

### A 29½"H Stool w/Silver Metal Footring Base 3985

Overall: 24½"W x 24½"D x 29½"H  
Seat: 14¼"W x 14¼"D x 29½"H  
List: \$223.00

### B 25¼"H Stool w/Silver Metal Footring Base 3965

Overall: 24"W x 24"D x 25¼"H  
Seat: 14¼"W x 14¼"D x 25¼"H  
List: \$209.00

Note: 3985, 3965 & 2700CASTERS can be shipped by a small package carrier.



### OPTIONAL CASTERS

(For 3985 & 3965)

### Casters (Set of 4) 2700CASTERS

List: \$58.00

(BK Black)



BK Black Plastic Seat



## NEW! ORION

Pictured w/NEW! American Elm Finish & NEW! OSTYP321 Typical

### A Mesh Back Task Chair w/Black Frame OSTW8001

Overall: 23<sup>1</sup>/<sub>16</sub>"W x 26"D x 37<sup>1</sup>/<sub>16</sub>"H  
Seat: 20<sup>1</sup>/<sub>16</sub>"W x 17<sup>1</sup>/<sub>2</sub>"D x 16<sup>1</sup>/<sub>16</sub>-23<sup>1</sup>/<sub>16</sub>"H  
List: \$516.00

Functions: Adjustable Seat Height,  
360 Degree Swivel, Tilt-Tension, Height  
Adjustable Arms

### B Mesh Back Managers Chair w/Black Frame OSTW8002

Overall: 23<sup>1</sup>/<sub>16</sub>"W x 26"D x 37<sup>1</sup>/<sub>16</sub>"H  
Seat: 20<sup>1</sup>/<sub>16</sub>"W x 18<sup>1</sup>/<sub>16</sub>-19<sup>3</sup>/<sub>4</sub>"D x 16<sup>1</sup>/<sub>16</sub>-23<sup>1</sup>/<sub>16</sub>"H  
List: \$680.00

Functions: Adjustable Seat Height, Seat Slider,  
360 Degree Swivel, Synchro-Tilt, Self-Adjusting  
Tilt, Tilt-Lock, Multi-Position Back Lock, Height  
Adjustable Arms



BK Black Mesh  
w/Mesh  
(OSTW8001  
& OSTW8002)

PW Pewter Mesh  
w/Mesh  
(OSTW8002 Only)



### CHAIR FEATURES



Managers chair has a synchro-tilt mechanism and seat slider



Both chairs have lumbar support and premium nylon mesh back and seat





## NEW! ORION

Pictured w/PL236 Conference Table & OS Laminate Storage (2) PL113, PL110 & PL207

### C Mesh Conference Chair w/Black Frame OSTW8003

Overall: 22<sup>1</sup>/<sub>8</sub>"W x 22<sup>1</sup>/<sub>2</sub>"D x 34<sup>1</sup>/<sub>2</sub>"H

Seat: 22<sup>3</sup>/<sub>4</sub>"W x 17<sup>1</sup>/<sub>2</sub>"D x 17<sup>5</sup>/<sub>16</sub>-27<sup>1</sup>/<sub>2</sub>"H

List: \$476.00

Functions: Adjustable Seat Height, 360 Degree Swivel, Tilt-Tension

### FEATURES

- Premium mesh back promotes air circulation
- Unique chair shape is designed for support and optimal comfort during long meeting hours
- Complements well with Orion task and manager chairs
- Perfect for your meeting or training rooms



Matching Orion Conference Chair



### CHAIR FEATURES



Fixed loop arms with a modern design



Spring tilt mechanism with tilt tension control for optimal productivity during long hours



BK Black Mesh  
w/Mesh  
(OSTW8003 Only)



**OSLO**

Pictured w/PL437 Conference Table

**A Mid Back Mesh Task Chair  
w/Adj. Arms & Black Frame  
600MMFBK**

Overall: 25"W x 22-24"D x 37-40¾"H

Seat: 18½"W x 19"D x 18-21¾"H

List: \$770.00

Functions: Adjustable Seat Height, Seat Slider, 360 Degree Swivel, Adjustable Lumbar Support, Tilt-Tension, Synchro-Tilt, Tilt-Lock, Multi-Position Back Lock, Height Adjustable Arms

**B Mid Back Mesh Task Chair  
w/Adj. Arms & Light Gray Frame  
601MMFGT**

Overall: 25"W x 22-24"D x 37-40¾"H

Seat: 18½"W x 19"D x 18-21¾"H

List: \$770.00

Functions: Adjustable Seat Height, Seat Slider, 360 Degree Swivel, Adjustable Lumbar Support, Tilt-Tension, Synchro-Tilt, Tilt-Lock, Multi-Position Back Lock, Height Adjustable Arms

600MMFBK Only

601MMFGT Only



Black Fabric  
w/Black Mesh Back

Dark Gray Fabric  
w/Light Gray Mesh Back



A



B

**CHAIR FEATURES**



Nylon mesh backrest promotes air circulation



Synchro-tilt mechanism and seat slider with height adjustable armrests

Note: Oslo task chairs can be shipped by a small package carrier.



# OSLO



**C Mid Back Mesh Conference Chair w/Black Frame & Fixed Arms**  
**602MMFBK**

Overall: 23½"W x 22-24"D x 37-40¾"H  
Seat: 18½"W x 19"D x 18-21¾"H  
List: \$770.00

*Functions: Adjustable Seat Height, Seat Slider, 360 Degree Swivel, Adjustable Lumbar Support, Tilt-Tension, Synchro-Tilt, Tilt-Lock, Multi-Position Back Lock*



**D Mid Back Mesh Conference Chair w/Light Gray Frame & Fixed Arms**  
**603MMFGT**

Overall: 23½"W x 22-24"D x 37-40¾"H  
Seat: 18½"W x 19"D x 18-21¾"H  
List: \$770.00

*Functions: Adjustable Seat Height, Seat Slider, 360 Degree Swivel, Adjustable Lumbar Support, Tilt-Tension, Synchro-Tilt, Tilt-Lock, Multi-Position Back Lock*



*Lumbar Support for All Day Comfort*

602MMFBK, 604MMFBK & 606MMFBK Only

603MMFGT & 605MMFGT Only



Black Fabric w/Black Mesh Back      Dark Gray Fabric w/Light Gray Mesh Back

Note: Oslo chairs can be shipped by a small package carrier.



**E Mesh Back Stacking Guest Chair w/Black Frame**  
**604MMFBK**

Overall: 24"W x 22½"D x 33½"H  
Seat: 19¾"W x 17¾"D x 18¾"H  
List: \$530.00



**F Mesh Back Stacking Guest Chair w/Light Gray Frame**  
**605MMFGT**

Overall: 24"W x 22½"D x 33½"H  
Seat: 19¾"W x 17¾"D x 18¾"H  
List: \$530.00



**G NEW! Mesh Back Armless, Stacking Guest Chair w/Black Frame**  
**606MMFBK**

Overall: 22½"W x 19½"D x 33½"H  
Seat: 19¾"W x 17¾"D x 18¾"H  
List: \$380.00

*Waterfall Front Edge Seat*

**STACKS HIGH**  
**4**  
With Casters



*Stacks 4 High (With or Without Casters)*

*Casters Included With Chair For Both Black & Gray Options - Stacking & Armless Stacking*



## INTERCHANGEABLE

Pictured w/NEW! American Elm Finish & NEW! Interchangeable Guest Chairs

### A Gray Or Black Mesh Back, Task Chair w/Black Seat & Black Base

**656MGF** (w/Gray Mesh Back)  
**656MBF** (w/Black Mesh Back)  
 Overall: 26½"W x 25½"D x 39-42"H  
 Seat: 19"W x 19"D x 18½-21½"H  
 List: \$602.00

Functions: Adjustable Seat Height, 360 Degree Swivel, Adjustable Lumbar Support, Tilt-Tension, Synchro-Tilt, Tilt-Lock, Height Adjustable Arms

### B Optional Interchangeable Seat Cover

**656COVERF** (Fabric)  
**656COVERA** (Antimicrobial Vinyl)  
 Fabric Cover List: \$30.00  
 Antimicrobial Vinyl Cover List: \$30.00

Gray Mesh Back Option  
 w/Optional Interchangeable Seat Cover in Steel Blue



Black Mesh Back Option  
 w/Black Fabric Seat



Optional Fabric Seat Cover Options



Optional Vinyl Seat Cover Options



### UNIQUE FEATURES

Change the seat color easily or remove it for cleaning. This chair allows you to do both or either

Note: This collection can be shipped by a small package carrier.





**NEW! INTERCHANGEABLE**

*Pictured w/NEW! Interchangeable Task Chair & PL437 Conference Table*

**C Black Mesh, High Back Task Chair w/Aluminum Arms & Base 6566AL**

Overall: 26<sup>7</sup>/<sub>8</sub>"W x 24<sup>13</sup>/<sub>16</sub>"D x 42<sup>3</sup>/<sub>4</sub>"H  
 Seat: 19"W x 19"D x 19-22"H  
 List: \$940.00

*Functions: Adjustable Seat Height, 360 Degree Swivel, Adjustable Lumbar Support, Tilt-Tension, Synchro-Tilt, Tilt-Lock*



*Padded Armrests*

**D Gray or Black Mesh Back, Armless Guest Chair w/Sled Base**

**6569MGF (Gray Mesh Back)**  
**6569MBF (Black Mesh Back)**  
 Overall: 25<sup>1</sup>/<sub>6</sub>"W x 19<sup>1</sup>/<sub>2</sub>"D x 39<sup>5</sup>/<sub>8</sub>"H  
 Seat: 19<sup>5</sup>/<sub>16</sub>"W x 19<sup>1</sup>/<sub>16</sub>"D x 18<sup>3</sup>/<sub>4</sub>"H  
 List: \$610.00



*Fixed Aluminum Arms For A Sleek Look*

**CHAIR FEATURES**



*Adjustable lumbar support for optimal comfort all day long*



*Synchro-tilt with tension and lock mechanisms*

**MATCHING GUEST CHAIR**

*See Page 151*



*Optional Fabric Seat Cover Options*



*Optional Vinyl Seat Cover Options*





**PALMA**

**A High Back, Ribbed Mesh Task Chair & Headrest w/Black Frame 200HMFBK**  
 Overall: 25 $\frac{5}{8}$ "W x 22 $\frac{1}{2}$ "D x 46 $\frac{5}{16}$ "-49 $\frac{13}{16}$ "H  
 Seat: 19 $\frac{3}{16}$ "W x 17 $\frac{3}{8}$ "-19 $\frac{3}{16}$ "D x 17 $\frac{1}{8}$ "-20 $\frac{1}{16}$ "H  
 List: \$1,116.00  
*Functions: Adjustable Seat Height, Seat Slider, 360 Degree Swivel, Adjustable Lumbar Support, Tilt-Tension, Synchro-Tilt, Tilt Lock, Height & Width Adjustable Arms*

**B High Back, Ribbed Mesh Task Chair & Headrest w/Light Gray Frame 201HMFGT**  
 Overall: 25 $\frac{5}{8}$ "W x 22 $\frac{1}{2}$ "D x 46 $\frac{5}{16}$ "-49 $\frac{13}{16}$ "H  
 Seat: 19 $\frac{3}{16}$ "W x 17 $\frac{3}{8}$ "-19 $\frac{3}{16}$ "D x 17 $\frac{1}{8}$ "-20 $\frac{1}{16}$ "H  
 List: \$1,116.00  
*Functions: Adjustable Seat Height, Seat Slider, 360 Degree Swivel, Adjustable Lumbar Support, Tilt-Tension, Synchro-Tilt, Tilt Lock, Height & Width Adjustable Arms*

**FEATURES**

- Includes height adjustable headrest that can be removed from chair if not needed
- Chair features 3D armrest, 3-Locking mechanism, seat slider and tension control functions

Note: Palma task chairs can be shipped by a small package carrier. 





## ENGAGE



### Mesh, Mid Back Task Chair w/Chrome Base 18921M

Overall: 25"W x 23 $\frac{3}{8}$ "D x 40 $\frac{3}{8}$ -43 $\frac{7}{8}$ "H  
Seat: 20"W x 24 $\frac{1}{2}$ "D x 19 $\frac{7}{8}$ -23 $\frac{1}{2}$ "H  
List: \$1,423.00

*Functions: Adjustable Seat Height, Seat Slider, 360 Degree Swivel, Tilt-Tension, Tilt-Lock, Multi-Position Back Lock, Height Adjustable Arms*



BK Black Mesh

### CHAIR DESIGN

*Passively supports your lumbar curve with a unique back design*



Note: Engage can be shipped by a small package carrier. 



## COSTA



### Task Chair w/Black Frame C12MBFSM

Overall: 25 $\frac{1}{2}$ "W x 25 $\frac{1}{4}$ "D x 39 $\frac{3}{4}$ -43"H  
Seat: 20 $\frac{1}{2}$ "W x 20 $\frac{1}{2}$ "D x 18 $\frac{1}{2}$ -21 $\frac{3}{4}$ "H  
List: \$669.00

*Functions: Adjustable Seat Height, 360 Degree Swivel, Tilt-Tension, Knee-Tilt, Independent Back Angle, Height Adjustable Arms*



BK Black Mesh

### CHAIR DESIGN

*Features seven ergonomic adjustments including adjustable arms*



Note: Costa can be shipped by a small package carrier. 





## COOLMESH PRO

*Pictured w/Variant - NEW! OSTYP301 Typical*

### FEATURES

- Hard, ratchet back provides support and durability
- Multi-functional chair offering many features and functions
- Choose between six fabric seat options, vinyl, leather or mesh
- Optional soft dual wheel casters and titanium base available

#### Cool Mesh Pro Multi-Function, High Back w/Black Base & Adj. Arms

Overall: 27½"W x 26⅞"D x 40⅝-44½"H

Seat: 20½"W x 19½"D x 19⅝-22⅞"H

**8014ASNSF** (Fabric Seats) List: \$1,037.00

**8014ASNSA** (AM Vinyl & Fabric Seats) List: \$1,037.00

**8014ASNSM** (Mesh Seat) List: \$1,114.00

**8014ASNSL** (Leather Seat) List: \$1,136.00

*Functions: Adjustable Seat Height, Ratchet Back, Seat Slider, 360 Degree Swivel, Tilt-Tension, Tilt-Lock, Forward Seat-Tilt, Independent Back Angle, Multi-Position Back Lock, Height & Width Adjustable Arms*



*Pictured w/Leather Seat*

#### OPTIONAL HEADREST

*(For 8014ASNS)*

**Headrest 7000HR**

List: \$105.00

*(BK Black)*



#### OPTIONAL CASTERS

*(For 8014ASNS)*

**Soft Dual Wheel**

*(Set of 5)*

**CASTERSPU**

List: \$55.00

*(BK Black)*



#### OPTIONAL BASE

*(For 8014ASNS)*

**Titanium Base**

**ABASET**

List: \$205.00



#### CHAIR FEATURE

*Chair provides lumbar support with curved back design*

Note: 8014ASNS, 7000HR, & CASTERSPU can be shipped by a small package carrier.

#### OfficeSource® CoolMesh Pro Seat Type Options - Build Your Custom Chair



*Note: When selecting chair, please choose seat cushion.*





## COOLMESH PRO

Pictured w/OS Training Tables - **NEW!** OSTYP326 Typical

### Nesting Chair w/Titanium Gray Frame

Overall: 24"W x 24¾"D x 38"H

Seat: 18½"W x 19¼"D x 18¾"H

**8094TNSF** (Fabric) List: \$652.00

**8094TNSA** (Vinyl) List: \$691.00

### FEATURES

- Hard, ratchet back provides support and durability
- Stylish mesh back has nesting capability and its soft seating will impress any guest
- Choose between four fabric seat options or black antimicrobial vinyl; matching task chair available
- Optional chair glides available in a set of four



Pictured  
w/Fabric Seat



Pictured  
w/Vinyl Seat



Nesting



Profile View

**OPTIONAL  
GLIDES**  
(For 8094TNS)

**Glides (Set of 4)**  
**2700GLIDES**  
List: \$53.00  
(BK Black)



BK Black Fabric

NV Navy Blue Fabric



GR Cool Gray Fabric

BL Celestial Blue Fabric



BK Black Antimicrobial  
PU Leather

Note: 8094TNS & 2700GLIDES can be shipped by a small package carrier.



**COOLMESH**  
Pictured w/Variant

**FEATURES**

- Ergonomically designed mesh back provides constant firmness and hugs the natural curve of the back
- Height and width adjustable arms with "ever soft" arm rest padding
- Choose between six fabric seat options, vinyl, leather or mesh
- Optional soft dual wheel casters and titanium base available

**Cool Mesh Multi-Function, High Back w/Seat Slider Standard Black Base, Black Mesh Back & Adj. Arms**

Overall: 25½"W x 26"D x 40½-44"H

Seat: 20½"W x 19½"D x 17½-21"H

7704ASNSF (Fabric Seats) List: \$963.00

7704ASNSA (AM Vinyl & Fabric Seats) List: \$963.00

7704ASNSM (Mesh Seat) List: \$1,040.00

7704ASNSL (Leather Seat) List: \$1,062.00

Functions: Adjustable Seat Height, Seat Slider, 360 Degree Swivel, Tilt-Tension, Tilt-Lock, Forward Seat-Tilt, Independent Back Angle, Multi-Position Back Lock, Height & Width Adjustable Arms



**CHAIR FEATURE**

Chair provides height and width adjustable arm rests

Note: 7704ASNS, 7000HR, & CASTERSPU can be shipped by a small package carrier.



Pictured w/Antimicrobial Fabric Seat

**OPTIONAL HEADREST**

(For 7704ASNS, 7701ASNS & 7754ASNS)

**Headrest 7000HR**

List: \$105.00 (BK Black)



**OPTIONAL CASTERS**

(For 7704ASNS, 7701ASNS & 7754ASNS)

**Soft Dual Wheel (Set of 5)**

**CASTERSPU**  
List: \$55.00 (BK Black)



**OPTIONAL BASE**

(For 7704ASNS, 7701ASNS & 7754ASNS)

**Titanium Base ABASET**

List: \$205.00



*OfficeSource® CoolMesh Seat Type Options - Build Your Custom Chair*



Note: When selecting chair, please choose seat cushion.



# COOLMESH



Pictured w/Antimicrobial Fabric Seat



Pictured w/Vinyl Seat

## Cool Mesh Synchro, High Back w/Seat Slider & Black Frame

Overall: 26¾"W x 25"D x 41¼-45"H  
 Seat: 20½"W x 19½"D x 17¾-21¼"H  
**7701ASNSF** (Fabric Seats) List: \$878.00  
**7701ASNSA** (AM Vinyl & Fabric Seats) List: \$878.00  
**7701ASNSM** (Mesh Seat) List: \$955.00  
**7701ASNSL** (Leather Seat) List: \$977.00

Functions: Adjustable Seat Height, Seat Slider, 360 Degree Swivel, Tilt-Tension, Tilt-Lock, Height & Width Adjustable Arms

## Nesting Chair w/Titanium Gray Frame

Overall: 24"W x 24"D x 37"H  
 Seat: 18½"W x 19"D x 19¼"H  
**7794TNSF** (Fabric Seats) List: \$608.00  
**7794TNSA** (Vinyl Seats) List: \$647.00

## Nesting Armless Chair w/Titanium Gray Frame

Overall: 22"W x 24"D x 37"H  
 Seat: 18½"W x 19"D x 19¼"H  
**7774TNSF** (Fabric Seats) List: \$593.00  
**7774TNSA** (Vinyl Seats) List: \$632.00

Note: 7794TNS & 7774TNS Available in Black (BK), Navy Blue (NV), Celestial Blue (BL), Cool Gray (GR) or Black Antimicrobial PU Leather (BK) Only.

### OPTIONAL GLIDES

(For 7794TNS & 7774TNS)

Glides (Set of 4)

**2700GLIDES**

List: \$53.00

(BK Black)



## Cool Mesh Multi-Function, Mid Back w/Seat Slider & Black Frame

Overall: 26½"W x 27¼"D x 36-39½"H  
 Seat: 20½"W x 19½"D x 18½-22"H  
**7754ASNSF** (Fabric Seats) List: \$895.00  
**7754ASNSA** (AM Vinyl & Fabric Seats) List: \$895.00  
**7754ASNSM** (Mesh Seat) List: \$972.00  
**7754ASNSL** (Leather Seat) List: \$994.00

Functions: Adjustable Seat Height, Seat Slider, 360 Degree Swivel, Tilt-Tension, Tilt-Lock, Forward Seat-Tilt, Independent Back Angle, Multi-Position Back Lock, Height & Width Adjustable Arms

Note: All items on this page can be shipped by a small package carrier.



7794TNS - Pictured w/Vinyl Seat



7774TNS - Pictured w/Fabric Seat



Pictured w/Mesh Seat

### OfficeSource® CoolMesh Seat Type Options - Build Your Custom Chair



Note: When selecting chair, please choose seat cushion.



## COOLMESH

Pictured w/OS Laminate & Dover Seating - OS266 Typical

### Cool Mesh Swivel Tilt, High Back Task Chair w/Arms & Black Frame

Overall: 26¾"W x 25¼"D x 41½-44¾"H

Seat: 20½"W x 19½"D x 17¾-21¼"H

7721ANSF (Fabric Seats) List: \$776.00

7721ANSA (AM Vinyl & Fabric Seats) List: \$776.00

7721ANSM (Mesh Seat) List: \$853.00

7721ANSL (Leather Seat) List: \$875.00

Functions: Adjustable Seat Height, 360 Degree Swivel, Tilt-Tension, Tilt-Lock, Height & Width Adjustable Arms

#### OPTIONAL BASE

(For 7721ANS & 7621ANS)

#### Titanium Base ABASET

List: \$205.00



#### OPTIONAL CASTERS

(For 7721ANS & 7621ANS)

#### Soft Dual Wheel (Set of 5)

#### CASTERSPU

List: \$55.00

(BK Black)



Note: 7721ANS & CASTERSPU can be shipped by a small package carrier.

## COOLMESH BASIC



### Cool Mesh Basic Task Chair w/Arms & Black Frame

Overall: 26½"W x 25¼"D x 36-40"H

Seat: 20½"W x 19½"D x 18-21¾"H

7621ANSF (Fabric Seats) List: \$662.00

7621ANSA (AM Vinyl & Fabric Seats) List: \$662.00

7621ANSM (Mesh Seat) List: \$739.00

7621ANSL (Leather Seat) List: \$761.00

Functions: Adjustable Seat Height, Ratchet Back, 360 Degree Swivel, Tilt-Tension, Tilt-Lock, Height & Width Adjustable Arms

Note: 7621ANS can be shipped by a small package carrier.



Pictured w/OS Laminate

#### OfficeSource® CoolMesh & Basic Seat Type Options - Build Your Custom Chair



Note: When selecting chair, please choose seat cushion.





## COOLMESH

Pictured w/OS Training Tables - OST07 Typical

### A Mesh Back Guest Chair w/Arms & Titanium Gray Frame

Overall: 25"W x 24"D x 36"H

Seat: 18"W x 19"D x 18"H

7804TGNSF (Fabric) List: \$516.00

7804TGNSA (Vinyl) List: \$547.00

### B Mesh Back Guest Chair w/Arms & Black Frame

Overall: 25¼"W x 24¾"D x 37"H

Seat: 18½"W x 18½"D x 19"H

7944GNSF (Fabric) List: \$569.00

7944GNSA (Vinyl) List: \$599.00

Note: CoolMesh chairs can be shipped by a small package carrier. 

### OPTIONAL CASTERS

(For 7804TGNS & 7944GNS)

Casters (Set of 4)

2700CASTERS

List: \$58.00

(BK Black)



STACKS  
H  
I  
G  
H  
↑  
4  
Without Casters



Stacking

STACKS  
H  
I  
G  
H  
↑  
5  
Without Casters



Shown w/Optional Casters



BK Black Fabric



NV Navy Blue Fabric



BL Celestial  
Blue Fabric  
(7944GNS Only)



GR Cool Gray Fabric



BK Black Antimicrobial  
PU Leather



**ADVANCED**  
 Pictured w/OS Laminate - OS127 Typical

**A Multi-Function High Back Task Chair w/Adj. Arms & Black Base 8456ASF**

Overall: 27¼"W x 25½"D x 41-44½"H  
 Seat: 21"W x 19"D x 18-22"H  
 List: \$932.00

*Functions: Adjustable Seat Height, Seat Slider, 360 Degree Swivel, Tilt-Tension, Tilt-Lock, Forward Seat-Tilt, Multi-Position Back Lock, Height & Width Adjustable Arms*



**B Guest Chair w/Arms & Titanium Gray Frame 2904TGF**

Overall: 25¾"W x 24"D x 32¼"H  
 Seat: 18½"W x 19"D x 18"H  
 List: \$462.00



BK Black Fabric

Note: Advanced can be shipped by a small package carrier.



Stacking

**OPTIONAL CASTERS** (For 2904TGF)

**Casters (Set of 4)**  
**2700CASTERS**  
 List: \$58.00  
 (BK Black)





## SPICE



### Mid Back Task Chair, Mesh Back w/Black Frame

Overall: 26½"W x 25"D x 36¾-40¼"H

Seat: 20"W x 19"D x 17¾-21¼"H

**7854ANSF** (Fabric Seats) List: \$704.00

**7854ANSA** (AM Vinyl & Fabric Seats) List: \$704.00

**7854ANSL** (Leather Seat) List: \$803.00

*Functions: Adjustable Seat Height, 360 Degree Swivel, Tilt-Tension, Tilt-Lock, Height & Width Adjustable Arms*

This product is part of a complete collection.  
See Page 170

Note: Spice can be shipped by a  small package carrier.



### UNIQUE FEATURES

*Ergonomic and comfortable chair with height and width adjustable arms fit for any office setting*

### OfficeSource® Spice Seat Type Options - Build Your Custom Chair



BK Black Fabric



NV Navy Blue Fabric



BL Celestial Blue Fabric



GR Cool Gray Fabric



AS Ash Gray Antimicrobial Fabric

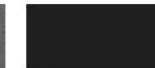

BK Black Antimicrobial PU Leather



BK Top Grain Leather



RD Red Fabric



OR Orange Fabric



CO Cobalt Blue Antimicrobial Fabric



OL Olive Green Antimicrobial Fabric



BK Mesh

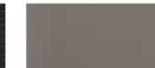

NP Neptune Antimicrobial PU Leather

*Note: When selecting chair, please choose seat cushion.*

## CRUSADER



### Mesh Back, Basic Task Chair w/Arms & Black Frame

**7621AAF**

Overall: 26½"W x 25¼"D x 36-40"H

Seat: 20½"W x 19½"D x 18-21¼"H

List: \$601.00

*Functions: Adjustable Seat Height, 360 Degree Swivel, Tilt-Tension, Tilt-Lock, Height & Width Adjustable Arms*



BK Black Fabric w/Mesh Back

Note: Crusader can be shipped by a  small package carrier.

### CHAIR DESIGN

*Height and width adjustable arms with soft, padded armrests*



*Pictured w/OS Laminate - OSB21 Typical*



## CADE

Pictured w/OS Laminate - OS244 Typical

### A Executive Mesh Back Chair w/Black Frame

44021BK

Overall: 24"W x 22½"D x 38-43"H

Seat: 19½"W x 19"D x 18-23"H

List: \$685.00

Functions: Adjustable Seat Height,  
360 Degree Swivel, Tilt-Tension,  
Tilt-Lock, Height Adjustable Arms



#### CHAIR DESIGN

Chair features height adjustable arm and various other chair functions that promote comfort



BK Black Fabric  
w/Mesh

Note: Cade can be shipped by a small package carrier. 

## ARTESA



### Basic Mesh Task Chair w/Painted Metallic Nylon Base & Arms

11501F

Overall: 25¾"W x 23½"D x 36¾-40¾"H

Seat: 20"W x 19¾"D x 17¾-21¾"H

List: \$716.00

Functions: Adjustable Seat Height, Ratchet  
Back, Seat Depth Adjustment, 360 Degree  
Swivel, Adjustable Lumbar Support, Tilt-  
Tension, Height Adjustable Arms



BK Black Airmesh Seat

#### CHAIR DESIGN

Adjustable lumbar with  
a hard, plastic back for  
optimal support



Note: Artesa can be shipped by a small package carrier. 





## CROSSWAY

Pictured w/OS Laminate Standing Desks

### A Mesh Back Task Chair w/Black Base 610F

Overall: 25"W x 26½"D x 36½-40"H  
 Seat: 19"W x 17½"D x 18-21½"H  
 List: \$356.00

Functions: Adjustable Seat Height,  
 360 Degree Swivel, Tilt-Tension, Tilt-Lock,  
 Fixed Arms

### B Mesh Back Guest Chair w/Arms & Black Frame

Overall: 24"W x 24"D x 33"H  
 Seat: 18"W x 18"D x 19½"H  
 2029F (Fabric Seat) List: \$285.00  
 2029V (Vinyl Seat) List: \$290.00

### C Mesh Back Armless Guest Chair w/Black Frame

Overall: 24"W x 24"D x 33"H  
 Seat: 18"W x 18"D x 19½"H  
 2028F (Fabric Seat) List: \$270.00  
 2028V (Vinyl Seat) List: \$275.00

Note: All items on this page can be shipped by a small package carrier. 



A



B

STACKS  
 HIGH  
 4  
 ↑



C



BK Black Fabric  
 w/Mesh Back



BK Black  
 Leather Soft Vinyl  
 (2029V & 2028V Only)



## FRANKLIN

*Pictured w/Variant - NEW! OSTYP303 Typical*

### A Mesh Swivel Chair w/Black Frame & Base

**21621M**

Overall: 23¾"W x 20"D x 35¾-39¾"H

Seat: 19½"W x 18"D x 17¾-21¾"H

List: \$774.00

*Functions: Adjustable Seat Height, 360 Degree Swivel*



### B Mesh Guest Chair w/Black Sled Base

**21628M**

Overall: 22½"W x 19¾"D x 36¼"H

Seat: 19½"W x 18"D x 17¾"H

List: \$774.00



### CHAIR FEATURES

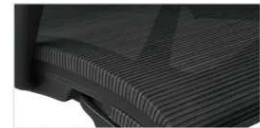

*All mesh upholstery for both chairs allows heightened ventilation and breath-ability*



*Single-piece back and seat are contoured for ergonomic support with fixed loop arms*



BK Black Mesh



SI Silver Mesh

Note: Franklin can be shipped by a small package carrier. 





**FRANKLIN**

*Pictured w/Sienna Conference Table - See Page 19*

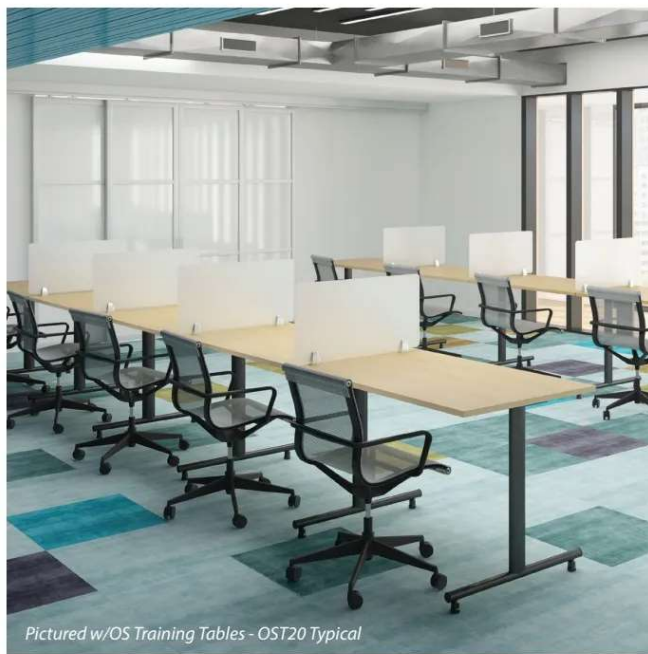

*Pictured w/OS Training Tables - OST20 Typical*



*Pictured w/Variant - NEW! OSTYP325 Typical*



BK Black Mesh



SI Silver Mesh

Note: Franklin can be shipped by a small package carrier. 



*Pictured w/OS Laminate – OS235 Typical*

## PLEXUS

### Mesh Back Task Chair w/Arms & Black Base P11MBFSF

Overall: 25"W x 24½"D x 37-41"H  
Seat: 20½"W x 20"D x 18-22"H  
List: \$461.00

Functions: Adjustable Seat Height, 360 Degree Swivel, Tilt-Tension, Tilt-Lock



BK Black Fabric  
w/Mesh Back

#### CHAIR DESIGN

*Curved back design  
provides optimal comfort  
and support*

Note: Plexus chair can be shipped by a small package carrier.



## SERENE



### A Flip Arm Mesh Back Task Chair w/Black Frame S13MBVSV

Overall: 25½"W x 26¼"D x 37-41"H  
Seat: 20½"W x 20"D x 17¼-21¼"H  
List: \$537.00

Functions: Adjustable Seat Height, 360 Degree Swivel, Tilt-Tension, Tilt-Lock, Flip-up Arms



BK Black Vinyl  
w/Mesh Back

### B Flip Arm Mesh Back Task Chair w/Black Frame 678F

Overall: 27"W x 27"D x 41-44"H  
Seat: 20"W x 20½"D x 18-21"H  
List: \$603.00

Functions: Adjustable Seat Height, 360 Degree Swivel, Adjustable Lumbar Support, Tilt-Tension, Tilt-Lock, Flip-up Arms



BK Black Fabric  
w/Mesh Back

## PENNINGTON



#### PENNINGTON CHAIR

*Task chair includes a  
4" thick seat cushion and  
adjustable lumbar support*

Note: Serene & Pennington chairs can be shipped by a small package carrier.



#### SERENE + PENNINGTON

*Both chairs have a flip-up  
armrest design*





*Pictured w/OS Conference Table*

## EMPIRE

**A Executive, Leather High Back  
w/Chrome Frame  
01CU2AHACL**

Overall: 29"W x 29½"D x 47¼-50¾"H  
Seat: 21"W x 17½"D x 18¼-21"H  
List: \$1,462.00

*Functions: Adjustable Seat Height, 360  
Degree Swivel, Tilt-Tension, Weight-  
Activated Recline*

**B Executive, Leather Mid Back  
w/Chrome Frame  
01CU2AMACL**

Overall: 28¾"W x 28"D x 38¾-41¾"H  
Seat: 21"W x 17½"D x 17-19¾"H  
List: \$1,252.00

*Functions: Adjustable Seat Height, 360  
Degree Swivel, Tilt-Tension, Weight-  
Activated Recline, Tilt-Lock*



### CHAIR DESIGN

*Exclusive weight  
activated chair  
mechanism and various  
other chair functions*



BK Black Top Grain  
Leather



*Sleek & Contemporary  
Profile*





## VENETO

Pictured w/OS Laminate - OS19V Typical

### A Executive High Back Chair w/Polished Aluminum Frame 300HL

Overall: 23<sup>7</sup>/<sub>8</sub>"W x 23<sup>7</sup>/<sub>16</sub>"-25"D x 40<sup>9</sup>/<sub>16</sub>"-43<sup>1</sup>/<sub>8</sub>"H

Seat: 20<sup>1</sup>/<sub>8</sub>"W x 17<sup>3</sup>/<sub>4</sub>"-19<sup>5</sup>/<sub>16</sub>"D x 17<sup>3</sup>/<sub>8</sub>"-19<sup>1</sup>/<sub>16</sub>"H

List: \$2,595.00

Functions: Adjustable Seat Height, Seat Slider, 360 Degree Swivel, Tilt-Tension, Synchro-Tilt, Tilt-Lock



#### CHAIR FEATURES

Polished aluminum frame, fixed loop armrests and base

Note: Veneto chairs can be shipped by a small package carrier. 



CA Caramel  
Microfiber Leather

GR Gray  
Microfiber Leather

NEW! BK Black  
Microfiber Leather







**VENETO**

*Pictured w/OS Conference Table in NEW! American Elm Finish*

**FEATURES**

- High and Mid Back chairs have a 3-locking mechanism, seat slider, tension control and additional chair functions for the busy executive
- Choose between three modern upholstery colors: Caramel, Gray or NEW! Black Microfiber Leather



**CHAIR FEATURES**

*Discreet under-seat controls with 3-position locking recline and seat slider for functionality*



**B Executive Mid Back Chair w/Polished Aluminum Frame 301ML**

Overall: 23<sup>7</sup>/<sub>8</sub>"W x 23<sup>7</sup>/<sub>16</sub>"-25"D x 38-40<sup>9</sup>/<sub>16</sub>"H  
 Seat: 20<sup>1</sup>/<sub>8</sub>"W x 17<sup>3</sup>/<sub>4</sub>"-19<sup>5</sup>/<sub>16</sub>"D x 17<sup>3</sup>/<sub>8</sub>"-19<sup>15</sup>/<sub>16</sub>"H  
 List: \$2,395.00

*Functions: Adjustable Seat Height, Seat Slider, 360 Degree Swivel, Tilt-Tension, Synchro-Tilt, Tilt-Lock*

Note: Veneto chairs can be shipped by a small package carrier. 📦



## BRADLEY

Pictured w/OS Conference Table - PLELP236 Typical

### Executive High Back w/Chrome Frame & Base 74011A

Overall: 27¼"W x 31"D x 46¾-50"H

Seat: 20½"W x 20¾"D x 17¾-20½"H

List: \$1,324.00

Functions: Adjustable Seat Height, 360 Degree Swivel, Adjustable Lumbar Support, Tilt-Tension, Tilt-Lock



BK Black  
Antimicrobial  
PU Leather

GR Light Gray  
Antimicrobial  
PU Leather

#### CHAIR DESIGN

Chair comes with a adjustable lumbar support and built-in padded headrest for optimal comfort while sitting



Note: Bradley can be shipped by a small package carrier. 



## PRESTIGE



Note: Prestige can be shipped by a small package carrier. 

### A Executive High Back w/Chrome Frame & Base 7765V

Overall: 27"W x 29½"D x 45-48"H  
Seat: 20"W x 20"D x 19-22"H  
List: \$1,062.00

Functions: Adjustable Seat Height,  
360 Degree Swivel, Tilt-Tension, Tilt-  
Lock, Knee-Tilt, Multi-Position Back Lock

### B Executive Mid Back w/Chrome Frame & Base 7745V

Overall: 27"W x 28"D x 38-41"H  
Seat: 20"W x 20"D x 19-22"H  
List: \$980.00

Functions: Adjustable Seat Height,  
360 Degree Swivel, Tilt-Tension, Tilt-  
Lock, Knee-Tilt, Multi-Position Back Lock



BK Black PU Leather

#### CHAIR DESIGN

Chair comes with a knee  
tilt function and padded  
armrests for comfort

## ARC



Note: Arc can be shipped by a small package carrier. 

### Executive High Back w/Fixed Arms & High Crown Chrome Base 514V

Overall: 25¼"W x 30½"D x 44¼"-47¼"H  
Seat: 19¾"W x 21"D x 19¾"-22¾"H  
List: \$904.00

Functions: Adjustable Seat Height, 360 Degree  
Swivel, Tilt-Tension, Tilt-Lock



GR Gray PU Leather



BK Black PU Leather

#### CHAIR DESIGN

Chair comes with a spring  
tilt mechanism with  
many other functions



# RIDGE



**A Executive High Back, Ribbed Back Task Chair w/Chrome Base 05RG2QHAV**

Overall: 29"W x 23½"D x 42-45"H  
 Seat: 20½"W x 18"D x 17¾-20¾"H  
 List: \$934.00

Functions: Adjustable Seat Height, 360 Degree Swivel, Tilt-Tension, Tilt-Lock



**B Executive Mid Back Armless, Ribbed Back Task Chair w/Chrome Base 05RG2WMAV**

Overall: 26"W x 23"D x 35½-38½"H  
 Seat: 20"W x 18"D x 17-20"H  
 List: \$664.00

Functions: Adjustable Seat Height, 360 Degree Swivel, Tilt-Tension, Tilt-Lock



**C Guest Chair w/Chrome Sled Base 9509V**

Overall: 22¾"W x 24"D x 37"H  
 Seat: 20"W x 18"D x 19"H  
 List: \$493.00



**CHAIR DESIGN**  
 Zippered, removable arm pads that can be replaced or taken off for executive high back chair only



**BK Black**  
 Leather Soft Vinyl

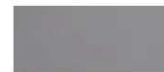

**GR Gray**  
 Leather Soft Vinyl

Note: Ridge chairs can be shipped by a small package carrier.





# MERAK

Pictured w/NEW! Lucca in Cypress with Pearl White Finish - See Pages 16-17

## A Executive High Back w/Chrome Base 1501V

Overall: 27"W x 29"D x 43¼-46¾"H  
Seat: 20¼"W x 21½"D x 20-23"H  
List: \$948.00

Functions: Adjustable Seat Height,  
360 Degree Swivel, Tilt-Tension, Tilt-Lock,  
Multi-Position Back Lock



## B Executive Mid Back w/Chrome Base 1505V

Overall: 27"W x 27"D x 38-41"H  
Seat: 19"W x 20"D x 20-23"H  
List: \$930.00

Functions: Adjustable Seat Height,  
360 Degree Swivel, Tilt-Tension, Tilt-Lock,  
Multi-Position Back Lock



## C Sled Base Guest Chair w/Chrome Base 1509V

Overall: 27"W x 27"D x 41"H  
Seat: 19½"W x 21"D x 18½"H  
List: \$884.00

### CHAIR DESIGN

All Merak chairs come with a smooth back design complementing its sleek chrome frame



BK Black  
PU Leather



GR Gray  
PU Leather



WH White  
PU Leather



NEW! CA Caramel  
PU Leather

Note: Merak chairs can be shipped by a small package carrier.

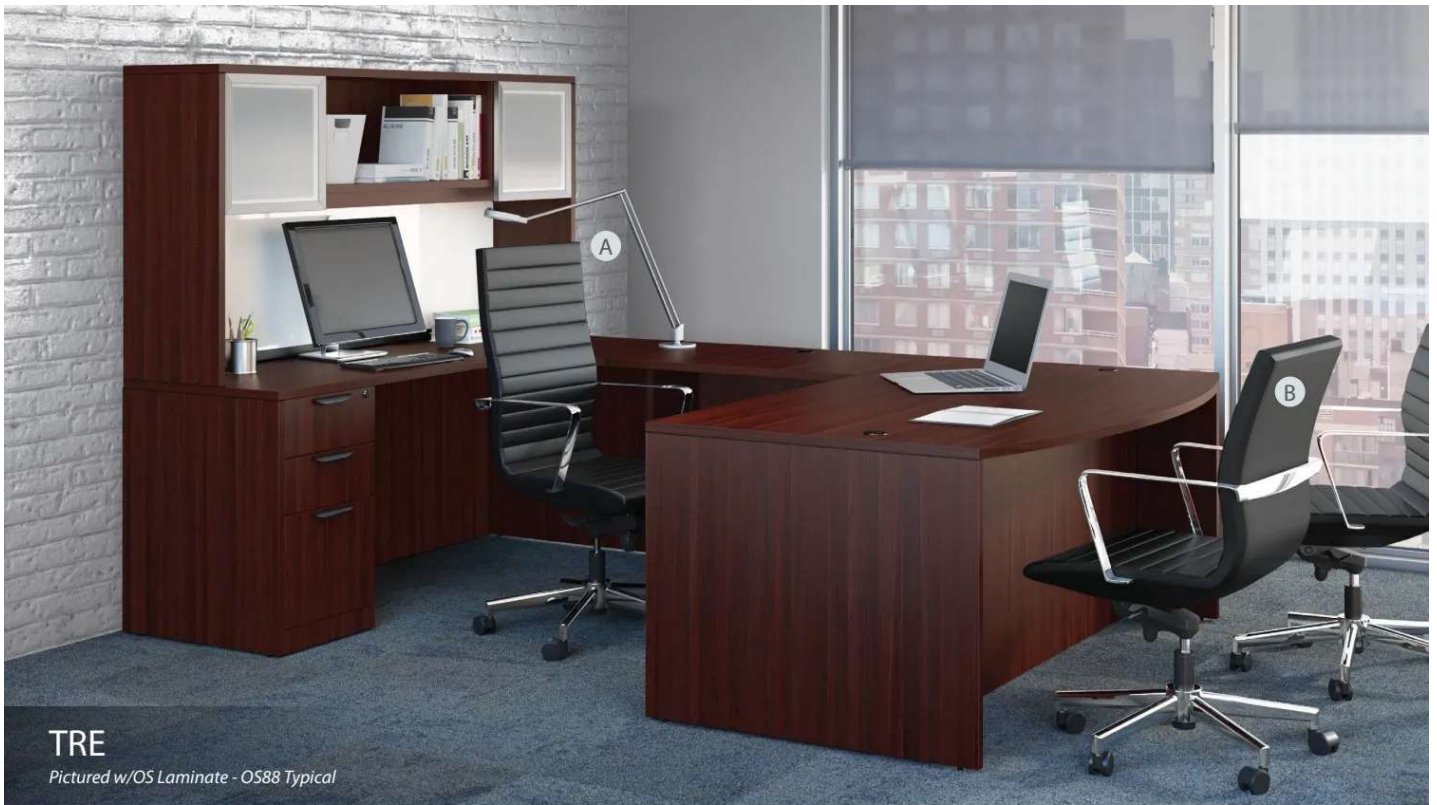

**TRE**

*Pictured w/OS Laminate - OS88 Typical*

**A Executive High Back  
w/Chrome Base**

**50811KTA**

Overall: 25¾"W x 25¾"D x 44-47¼"H

Seat: 19¾"W x 19"D x 18¼-21½"H

List: \$1,477.00

*Functions: Adjustable Seat Height, 360  
Degree Swivel, Tilt-Tension, Tilt-Lock, Knee-Tilt*

**B Executive Mid Back  
w/Chrome Base**

**50821KTA**

Overall: 25¾"W x 25¾"D x 37¾-41"H

Seat: 19¾"W x 19"D x 18¼-21½"H

List: \$1,349.00

*Functions: Adjustable Seat Height, 360  
Degree Swivel, Tilt-Tension, Tilt-Lock, Knee-Tilt*

**C Executive Guest Sled Base Chair  
w/Chrome Base**

**50828A**

Overall: 22½"W x 24¾"D x 37¾"H

Seat: 19¾"W x 19"D x 19¼"H

List: \$1,034.00



**BK Black**  
Antimicrobial  
PU Leather

**GT Light Gray**  
Antimicrobial  
PU Leather



Note: Tre chairs can be shipped by a small package carrier. 





## TRE LITE

Pictured w/OS Conference / Multi-Purpose - NEW! OSTYP313 Typical

### A Executive High Back w/Chrome Base 60811A

Overall: 25½"W x 25½"D x 41¾-45"H  
Seat: 19¾"W x 19"D x 16¾-20"H  
List: \$1,327.00

Functions: Adjustable Seat Height, 360 Degree Swivel, Tilt-Tension, Tilt-Lock



### B Executive Mid Back w/Chrome Base 60821A

Overall: 25½"W x 25½"D x 35½-38½"H  
Seat: 19¾"W x 19"D x 16¾-20"H  
List: \$1,198.00

Functions: Adjustable Seat Height, 360 Degree Swivel, Tilt-Tension, Tilt-Lock



### C Executive Guest Chair w/Chrome Sled Base 50828A

Overall: 22½"W x 24¾"D x 37¾"H  
Seat: 19¾"W x 19"D x 19¼"H  
List: \$1,034.00

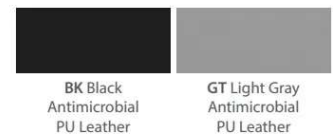

## BOXERO



### Executive High Back w/Chrome Base 1401V

Overall: 23¼"W x 29¼"D x 40¾-43¾"H  
Seat: 19¼"W x 19¼"D x 19-22"H  
List: \$687.00

Functions: Adjustable Seat Height,  
360 Degree Swivel, Tilt-Tension, Tilt-Lock



BK Black PU Leather



GR Gray PU Leather

#### CHAIR DESIGN

Chair comes with a spring  
tilt mechanism with  
many other functions



Note: Boxero can be shipped by a small package carrier. 

## STUDIO



### Executive Mid Back Chair w/Chrome Base 696V

Overall: 27"W x 30"D x 40-43"H  
Seat: 19¾"W x 19"D x 19-22"H  
List: \$621.00

Functions: Adjustable Seat Height,  
360 Degree Swivel, Tilt-Tension, Tilt-Lock

#### CHAIR DESIGN

Easily remove and replace  
the arm pads of this chair  
with no effort



BK Black PU Leather



GR Gray PU Leather



RD Red PU Leather



WH White PU Leather

Note: Studio can be shipped by a small package carrier. 



# OBSIDIAN



**A High Back Executive Task Chair w/Adj. Arms & Black Base**  
**05AG2QHEV**

Overall: 27"W x 29"D x 44-47"H  
 Seat: 20"W x 18½"D x 19½-22½"H  
 List: \$916.00

*Functions: Adjustable Seat Height, 360 Degree Swivel, Tilt-Tension, Tilt-Lock, Independent Back Angle, Multi-Position Back Lock, Height Adjustable Arms*



**B NEW! High Back Executive Conference Chair w/Fixed Aluminum Arms & Base**  
**OSEC9001**

Overall: 30⅞"W x 26⅜"D x 46⅜"H  
 Seat: 20½"W x 17⅝"D x 20⅝-23¼"H  
 List: \$1,200.00

*Functions: Adjustable Seat Height, 360 Degree Swivel, Synchro Tilt Mechanism, Self-Adjusting Tilt Recline, Infinite Tilt Lock (Back Cushion)*



BK Black PU Leather

Note: Obsidian can be shipped by a small package carrier. 



## CHAIR FEATURES

*Discreet recline and lock control levers underneath seat cushion for conference chair*



*Extra thick, padded seat cushion for optimal long-term comfort throughout your day*



*Conference chair includes lightly padded, fixed aluminum armrests with an aluminum base*



*Conference chair includes an all pull lever control system with a synchro tilt mechanism and infinite tilt lock*



Pictured w/Palissades

# LANCASTER



**A High Back Executive Swivel w/Mahogany Base 378V**  
 Overall: 27½"W x 30"D x 42-45½"H  
 Seat: 24"W x 20"D x 20-23½"H  
 List: \$1,339.00  
 Functions: Adjustable Seat Height, 360 Degree Swivel, Tilt-Tension, Tilt-Lock



**B High Back Executive Swivel w/Mahogany Frame & Base 294V**  
 Overall: 27"W x 28"D x 43½-47"H  
 Seat: 24"W x 19"D x 19½-23"H  
 List: \$1,015.00  
 Functions: Adjustable Seat Height, 360 Degree Swivel, Tilt-Tension, Tilt-Lock

## FEATURES

- Blend of traditional & contemporary design
- Mahogany wood finish frame



**C Guest Chair w/Mahogany Frame 291V**  
 Overall: 24½"W x 27"D x 35½"H  
 Seat: 20"W x 19"D x 18"H  
 List: \$818.00



**D Guest Chair w/Mahogany Frame 271V**  
 Overall: 24"W x 26"D x 31"H  
 Seat: 22"W x 21"D x 18½"H  
 List: \$538.00



**E Guest Chair w/Mahogany Frame & Casters 272V**  
 Overall: 24"W x 26"D x 31"H  
 Seat: 22"W x 21"D x 18½"H  
 List: \$570.00

## GUEST CHAIR FEATURES



Bold, antique brass rivets along the armrests and bottom of the seat cushion



Antique brass framework mounts to the durable casters for a mobile option



BK Black  
 Leather Soft Vinyl

Note: 294V, 291V, 271V & 272V on this page can be shipped by a small package carrier.



# CHARLESTON



**Executive High Back, Tufted Seat & Back w/Mahogany Arms & Base 20271A**

Overall: 28½"W x 32"D x 47-49¾"H  
 Seat: 23"W x 18½"D x 20½-23¼"H  
 List: \$1,561.00

Functions: Adjustable Seat Height, 360 Degree Swivel, Tilt-Lock

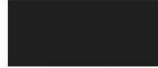

BK Black  
 Antimicrobial  
 PU Leather

**CHAIR DESIGN**

Plastic, wooden base and arm material with mahogany look



Note: Charleston can be shipped by a small package carrier.

# SPENCER

**A Executive High Back w/Mahogany Frame & Base 1265V**

Overall: 27"W x 28"D x 46-49½"H  
 Seat: 21"W x 20½"D x 19-22½"H  
 List: \$832.00

Functions: Adjustable Seat Height, 360 Degree Swivel, Tilt-Tension, Tilt-Lock

**B Executive Mid Back w/Mahogany Frame & Base 1245V**

Overall: 27"W x 28"D x 37-40"H  
 Seat: 21"W x 20½"D x 20-23"H  
 List: \$801.00

Functions: Adjustable Seat Height, 360 Degree Swivel, Tilt-Tension, Tilt-Lock

**C Guest Chair w/Mahogany Frame 1240V**

Overall: 26"W x 28"D x 36"H  
 Seat: 21"W x 20½"D x 19"H  
 List: \$669.00



BK Black  
 Leather Soft Vinyl

Note: Spencer chairs on this page can be shipped by a small package carrier.



## CONTOUR



### A Executive High Back w/Black Base 489L

Overall: 24¾"W x 28½"D x 45¼-48¼"H

Seat: 20¼"W x 19"D x 19-22"H

List: \$856.00

Functions: Adjustable Seat Height, 360 Degree Swivel, Tilt-Tension, Tilt-Lock, Knee-Tilt, Multi-Position Back Lock



BK Black  
Bonded Leather

#### CONTOUR CHAIR

Chair comes with a knee tilt function for optimal comfort while sitting

### B Executive High Back Chair w/Black Base 70101A

Overall: 25¼"W x 27½"D x 41½-44"H

Seat: 20½"W x 19¾"D x 17½-21"H

List: \$649.00

Functions: Adjustable Seat Height, 360 Degree Swivel, Tilt-Tension, Tilt-Lock



BK Black  
Antimicrobial  
PU Leather

## PROVIDENT



## SIERRA



### A Executive High Back w/Black Base 10311A

Overall: 26½"W x 28¼"D x 41½-44"H

Seat: 21¼"W x 21"D x 18½-21¼"H

List: \$936.00

Functions: Adjustable Seat Height, 360 Degree Swivel, Tilt-Tension, Tilt-Lock

### B Executive Mid Back w/Black Base 10321A

Overall: 26½"W x 28"D x 38½-41½"H

Seat: 21¼"W x 21"D x 18½-21¼"H

List: \$868.00

Functions: Adjustable Seat Height, 360 Degree Swivel, Tilt-Tension, Tilt-Lock



BK Black  
Antimicrobial  
PU Leather



Note: Contour, Provident & Sierra chairs can be shipped by a small package carrier. 





**ADVANTAGE**  
Pictured w/Variant

**A Executive High Back Chair  
w/Black Base  
1201V**

Overall: 24"W x 26¼"D x 40¼"-44"H  
Seat: 19¾"W x 18¼"D x 18¾"-22¼"H  
List: \$436.00

Functions: Adjustable Seat Height, 360 Degree Swivel, Tilt-Tension, Tilt-Lock

**B Executive Mid Back Chair  
w/Black Base  
1206V**

Overall: 24"W x 26¼"D x 37¼"-40¾"H  
Seat: 19¾"W x 18¼"D x 18½"-22"H  
List: \$396.00

Functions: Adjustable Seat Height, 360 Degree Swivel, Tilt-Tension, Tilt-Lock



**CHAIR FEATURES**



Chair comes with a tilt tension and tilt lock function with a waterfall edge seat



Crafted to take care of your posture during the long hours you spend at the office



BK Black PU Leather

Note: Advantage chairs can be shipped by a small package carrier. 📦



Pictured w/OS Laminate - OS89 Typical

## RYDE BIG & TALL

**Big & Tall High Back Gray Mesh Task Chair w/Flip Arms & Black Frame 2101HMFBT**

**Weight Capacity: 400 LBS**

Overall: 31"W x 30"D x 43<sup>13</sup>/<sub>16</sub>-46<sup>3</sup>/<sub>4</sub>"H

Seat: 22<sup>1</sup>/<sub>2</sub>"W x 21"D x 18<sup>15</sup>/<sub>16</sub>-21<sup>7</sup>/<sub>8</sub>"H

List: \$1,520.00

*Functions: Adjustable Seat Height, 360 Degree Swivel, Adjustable Lumbar Support, Tilt-Tension, Tilt-Lock, Height Adjustable Arms, Flip-up Arms*

### CHAIR DESIGN

*Mesh hard back with adjustable lumbar support with a spring pack seat construction for added support and comfort*



GRBK Black Fabric

Note: Ryde Big & Tall chair can be shipped by a small package carrier. 



Weight Capacity  
400 LBS



*Padded armrests flip up and down and are also height adjustable for optimal ergonomic performance*



## BIG & TALL



Weight  
Capacity  
400 LBS

### Mesh Back Executive Chair w/Heavy-Duty Chrome Base 05AB2QHBV

**Weight Capacity: 400 LBS**

Overall: 27"W x 31"D x 39½-42½"H  
Seat: 22¾"W x 19¾"D x 18¼-21¼"H  
List: \$1,099.00

*Function: Adjustable Seat Height,  
360 Degree Swivel, Adjustable  
Lumbar Support, Tilt-Tension,  
Synchro-Tilt, Tilt-Lock, Multi-Position  
Back Lock, Height Adjustable Arms*



BK Black  
Bonded Leather

#### CHAIR DESIGN

*Chair features  
adjustable lumbar  
support with a unique  
design that combines  
plastic and chrome*



## BIG & TALL



A

Weight  
Capacity  
400 LBS

### A Big & Tall High Back Chair w/Black Base 44088AF

**Weight Capacity: 400 LBS**

Overall: 28¾"W x 27¼"D x 41¾-44¾"H  
Seat: 22½"W x 18¾"D x 17¾-20¾"H  
List: \$1,185.00

*Functions: Adjustable Seat Height,  
360 Degree Swivel, Tilt-Tension, Tilt-Lock,  
Height Adjustable Arms*



BK Black Fabric  
w/Mesh Back

### B Mesh Back Guest Chair w/Arms & Black Frame 11789F

**Weight Capacity: 350 LBS**

Overall: 24¾"W x 25"D x 39½"H  
Seat: 22"W x 19½"D x 18¾"H  
List: \$727.00



BK Black Fabric  
w/Mesh Back



B

Weight  
Capacity  
350 LBS

#### CHAIR DESIGN

*Chair features a sturdy,  
durable back with padded  
armrests for optimal  
comfort all around*



Note: Big & Tall chairs on this page can be shipped by a small package carrier. 

## BIG & TALL



Weight Capacity  
500 LBS



*Pictured w/OS Laminata*

### Big & Tall High Back Chair w/Black Base 11667L

**Weight Capacity: 500 LBS**

Overall: 29 $\frac{1}{8}$ "W x 34 $\frac{1}{8}$ "D x 46 $\frac{1}{2}$ -50 $\frac{1}{8}$ "H

Seat: 25 $\frac{1}{8}$ "W x 22 $\frac{1}{8}$ "D x 20 $\frac{1}{2}$ -24 $\frac{1}{8}$ "H

List: \$1,477.00

*Functions: Adjustable Seat Height, 360 Degree Swivel, Tilt-Tension, Tilt-Lock*



BK Black  
Bonded Leather

## BIG & TALL



Weight Capacity  
400 LBS

### Big & Tall, Executive High Back Chair w/Black Frame 991V

**Weight Capacity: 400 LBS**

Overall: 33 $\frac{1}{2}$ "W x 31"D x 43-45 $\frac{1}{2}$ "H

Seat: 22 $\frac{1}{2}$ "W x 21"D x 20 $\frac{1}{4}$ -23"H

List: \$1,126.00

*Functions: Adjustable Seat Height, 360 Degree Swivel, Tilt-Tension, Tilt-Lock*



BK Black PU Leather

#### CHAIR DESIGN

*Chair features additional extra padding for a comfortable seat during those long work hours*



Note: 991 can be shipped by a small package carrier. 





## BIG & TALL



Weight  
Capacity  
400 LBS

### Big & Tall High Back Chair w/Chrome Frame 21041A

**Weight Capacity: 400 LBS**

Overall: 28½"W x 31"D x 44¼-47"H

Seat: 24¼"W x 19¾"D x 19¼-22"H

List: \$1,494.00

Functions: Adjustable Seat Height, 360  
Degree Swivel, Tilt-Tension, Tilt-Lock



BK Black  
Antimicrobial  
PU Leather

#### CHAIR DESIGN

Heavy-duty, butterfly  
mechanism puts tilt and  
lock at start position



Pictured w/OS Laminate - OS239 Typical

## BIG & TALL



Weight  
Capacity  
400 LBS

### Big & Tall Executive w/Silver Heavy-Duty Metal Base 993L

**Weight Capacity: 400 LBS**

Overall: 27"W x 31"D x 43½-46½"H

Seat: 21½"W x 18"D x 19½-22½"H

List: \$1,063.00

Functions: Adjustable Seat Height, 360  
Degree Swivel, Tilt-Tension, Tilt-Lock



BK Black  
Bonded Leather

#### CHAIR DESIGN

Chair features fixed,  
heavy-duty loops arms  
with padded armrests  
for optimal comfort





BIG & TALL



Weight  
Capacity  
500 LBS

**Guest Chair w/Silver Frame  
11499V**  
**Weight Capacity: 500 LBS**  
Overall: 30¾"W x 28¾"D x 34¼"H  
Seat: 27"W x 19½"D x 19⅞"H  
List: \$1,131.00



Weight  
Capacity  
275 LBS

**Guest Chair w/Silver Frame  
11494V**  
**Weight Capacity: 275 LBS**  
Overall: 26⅞"W x 28¾"D x 34⅞"H  
Seat: 23½"W x 19½"D x 19¼"H  
List: \$947.00



Weight  
Capacity  
500 LBS

**Bench w/Silver Frame  
11490V**  
**Weight Capacity: 500 LBS**  
Overall: 43⅞"W x 18½"D x 18⅞"H  
Seat: 43⅞"W x 18½"D x 18⅞"H  
List: \$746.00

**FEATURES**

- Medical-grade, easy to clean vinyl
- Wall saver back leg design
- Heavy-duty construction



**CHAIR FEATURES**

*Waterfall seat cushion design helps to prevent leg fatigue over time*



BK Black PU Leather



## BIG & TALL



Weight  
Capacity  
500 LBS

**Guest Chair w/Arms & Black Frame**  
**59051FPA** (Black Antimicrobial Vinyl Only)  
**Weight Capacity: 500 LBS**  
Overall: 32"W x 25"D x 33"H  
Seat: 26"W x 19½"D x 18"H  
List: \$792.00



Weight  
Capacity  
400 LBS

**Armless, Guest Chair w/Black Frame**  
**59054FPA**  
**Weight Capacity: 400 LBS**  
Overall: 26"W x 22"D x 33"H  
Seat: 22½"W x 19"D x 18"H  
List: \$602.00



59054FPA Shown - Profile View



Weight  
Capacity  
400 LBS

**Guest Chair w/Arms & Black Frame**  
**59052FPA**  
**Weight Capacity: 400 LBS**  
Overall: 27½"W x 24"D x 33"H  
Seat: 22½"W x 19"D x 18"H  
List: \$651.00



Weight  
Capacity  
300 LBS

**Guest Chair w/Arms & Black Frame**  
**59053FPA**  
**Weight Capacity: 300 LBS**  
Overall: 22"W x 23½"D x 33"H  
Seat: 19"W x 18½"D x 18"H  
List: \$538.00



59053FPA Shown - Front View

### FEATURES

- Medical-grade, easy to clean antimicrobial vinyl
- Wall saver back leg design with waterfall seat cushion
- Heavy-duty construction
- Adjustable levelers on all back legs of chairs helps with uneven floor surfaces



**BK Black**  
Antimicrobial Vinyl

**GR Gray**  
Antimicrobial Vinyl

Note: Big & Tall chairs on this page can be shipped by a small package carrier. 📦



## WHAT TO LOOK FOR IN AN OFFICE CHAIR

## CHAIR GUIDE FUNCTION GLOSSARY:

Proportional Adjustments	
Adjustable Seat Height	Adjusts the seat up and down to accommodate various body heights.
Ratchet Back	Allows the back of the chair to ratchet up or down in stages.
Seat Depth Adjustment	Adjusts the seat forward or backward to adjust to upper leg length.
Seat Slider	Moves the seat cushion forward or backward for additional seat depth.

Posture Controls	
360 Swivel Degree	Provides freedom of movement for the seat in any direction.
Adjustable Lumbar Support	Easily adjusts to custom fit your lumbar for optimal comfort and lower back support.
Tilt-Tension	Controls the resistance and rate of how the chair reclines.
Synchro-Tilt	Mechanism reclines the back at a higher ratio than the seat for proper back alignment.
Weight-Activated Recline	Mechanism will automatically adjust the synchro tension based on the user's weight.
Tilt-Lock	Locks the seat and back in an upright position.
Forward Seat-Tilt	Allows the seat to tilt forward for enhanced comfort when doing intensive forward-oriented tasks.
Knee-Tilt	Reclines the back at a higher ratio than the seat for proper back alignment. Pivot point is located near the front of the seat.
Independent Back Angle	Adjusts the angle of the back separately from the seat to reduce pressure on the lower spine.
Multi-Position Back Lock	Allows the user to adjust and lock the seat and back angle of the chair independently of each other.

Arm Adjustments	
Height Adjustable Arms	Moves up or down for shoulder and upper body support.
Width Adjustable Arms	Moves the arms toward and away from the body to adapt to various body sizes.
Height & Width Adjustable Arms	Moves up and down, and towards and away from the body to adapt to various body sizes.
All Adjustable Arms	Arms adjust in height, width, depth, and pivot.
Flip-up Arms	Arms flip up and back down into a fixed position.

### THE RIGHT FIT:

Finding the perfect chair requires striking a balance between style, price, and ergonomics. Understanding the various adjustments and features is the first step to helping your posture and making those long office hours as comfortable as possible.

### Big & Tall

6'2" or taller. Maximum weight limit on Big & Tall chairs is 350-400 lbs. \*Max weight is variable and noted in catalog.

### Standard

Up to 6'2". Maximum weight limit on Average chairs is 275 lbs.



# ADDITIONAL CHAIR ACCESSORY OPTIONS

## OPTIONAL CHAIR SEAT COVERS

### Optional Interchangeable Seat Cover

**656COVERF** (Fabric)

**656COVERA** (Antimicrobial Vinyl)

Fabric Cover List: \$30.00

Antimicrobial Vinyl Cover List: \$30.00

### FEATURES

- Interchangeable seat covers are the solution for anyone who likes to change up the look of their office space
- You can change as many times as you like while still offering comfort and durability
- They are easy to take off for cleaning and replacement
- Offered in a brilliant variety of fabric colors and antimicrobial vinyl; vinyl is great for healthcare or high use cleaning environments
- These seat covers will fit most chairs



Note: This product can be shipped by a small package carrier.



## OPTIONAL CASTERS & GLIDES

### A Soft Dual Wheel Casters CASTERSPUBK

List: \$55.00



BK Black

### B Optional Chair Glides 2700GLIDESBK

List: \$53.00

### C Optional Chair Glides NORGLIDESBK

List: \$49.00



### FEATURES

- Soft casters are made for hard flooring to prevent the natural wear and tear of your chair moving across your floor
- Glides make it easy to move your chair from one place to another without damaging your floor at all; screws are included with all glides
- Easily customize your task, mesh or guest seating with optional casters and glides to suit any office environment
- These are made to fit most chair models

Note: Check with your customer representative for any questions on compatibility issues.

Note: Products A, B & C can be shipped by a small package carrier.

## OPTIONAL CHAIR CYLINDERS



### Optional 100mm Cylinder NORCYLBK

List: \$51.00



BK Black

### FEATURES

- Weight Capacity of 275 lbs.
- Compatible with most mechanisms and chair bases
- Has an additional 20mm gas lift
- Longer or taller cylinders allow the chair height to be higher than standard height
- Cylinder roughly adds an additional 3/4"H

Note: Check with your customer representative for any questions on compatibility issues.

Note: This product can be shipped by a small package carrier.

# LAMINATE BOOKCASES

## FEATURES

- Finished, solid wooden back for heavy-duty use with a matching laminate
- 3mm PVC Dura-Edge on all exposed edges
- Spacious shelves
- Optional doors or 1" thick shelf
- Weight capacity of 50 lbs. per shelf



**A Bookcase w/2 Shelves**  
**PL154†**  
 31½"W x 14"D x 29½"H  
 List: \$359.00



**B Bookcase w/4 Shelves**  
**PL155†**  
 31½"W x 14"D x 47¼"H  
 List: \$472.00



**C Bookcase w/6 Shelves**  
**PL156†**  
 31½"W x 14"D x 71"H  
 List: \$670.00



**D Door Kit (Optional)**  
**PLBCDK†**  
*(For PL154, PL155 & PL156)*  
 List: \$253.00

Some items in this collection come ready-to-assemble.



*Pairs Well With OS Laminate Desks - OS239 Typical*



**F Corner Bookcase**  
**w/2 Shelves**  
**PL160**  
 24"W x 24"D x 30"H  
 List: \$716.00



**G Corner Bookcase**  
**w/3 Shelves**  
**PL161**  
 15"W x 15"D x 36"H  
 List: \$519.00

*Note: PL160 & PL161 Are Not Available In MA Maple or WH White.*



**NEW! AE American Elm**  
*(†Select SKUs)*

**CG Coastal Gray**

**ES Espresso**

**MW Modern Walnut**

**MH Mahogany**

**CH Cherry**

**WH White**  
*(Select SKUs)*

**MA Maple**  
*(Select SKUs)*

*Note: American Elm **only** available for select SKUs. Select SKUs are notated by a † mark at the end of their SKU.*



## STEEL BOOKCASES



**A 6 Shelves**  
**QSOSB6SLF82**  
 34½"W x 13"D x 82"H  
 List: \$1,440.00

**B 5 Shelves**  
**OSB5SLF72**  
 34½"W x 13"D x 72"H  
 List: \$1,232.00

**C 4 Shelves**  
**QSOSB4SLF60**  
 34½"W x 13"D x 60"H  
 List: \$1,098.00

**D 3 Shelves**  
**QSOSB3SLF42**  
 34½"W x 13"D x 42"H  
 List: \$840.00

**E 2 Shelves**  
**QSOSB2SLF30**  
 34½"W x 13"D x 30"H  
 List: \$707.00

*Note: OSB5SLF72 Stocked in Black & Light Gray Only. Putty is available through QuickShip Only.*



**QS = QUICKSHIP** Most Items in this collection come fully assembled.

## HEAVY DUTY WIRE RACKS



**A Wire Shelving Unit**  
**PWS722148**  
 Shelf Capacity: 250 lbs.  
 48"W x 21"D x 72"H  
 List: \$713.00

**B Wire Shelving Unit**  
**PWS722136**  
 Shelf Capacity: 300 lbs.  
 36"W x 21"D x 72"H  
 List: \$590.00



BK Black Metal

### OPTIONAL SHELF

**36"W Extra Shelf**  
 (Compatible w/PWS722136)  
**PWS1236**  
 List: \$77.00 ea.

**48"W Extra Shelf**  
 (Compatible w/PWS722148)  
**PWS1248**  
 List: \$130.00 ea.



## OS LAMINATE LATERAL FILES



**A 2 Drawer Lateral**  
**PL112†**  
35½"W x 22"D x 29½"H  
List: \$1,248.00



**B 3 Drawer Lateral**  
**PL183†**  
35½"W x 22"D x 42"H  
List: \$2,948.00



**C 4 Drawer Lateral**  
**PL184†**  
35½"W x 22"D x 54½"H  
List: \$3,612.00



**D Combo Lateral B/B/F**  
**w/One Lateral File**  
**PL114†**  
31"W x 22"D x 29½"H  
List: \$1,409.00

Note: Lateral files are for the storage of hanging file folders only and not for the storage of heavier objects.



**NEW! AE American Elm**  
(†Select SKUs)

**CG Coastal Gray**

**ES Espresso**

**MW Modern Walnut**

**MH Mahogany**

**CH Cherry**

**WH White**

**MA Maple**

Note: American Elm **only** available for select SKUs. Select SKUs are notated by a † mark at the end of their SKU.

Some items in this collection come ready-to-assemble.

## LATERAL FILES

### FEATURES

- Safety features include counter weights and an interlock system to prevent tipping
- Core-removable locks
- Heavy-duty full pull designer cabinet at an affordable price
- Reinforced heavy-gauge welded steel construction
- Standard with factory installed lock and hanging bars
- Powder coat paint
- Meets or exceeds ANSI/BIFMA performance standards

### 35½"Wide – Lateral Files

**A 2 Drawer Metal File**  
**8362**  
35½"W x 19¾"D x 27½"H  
List: \$1,203.00

**B 3 Drawer Metal File**  
**8363**  
35½"W x 19¾"D x 39¾"H  
List: \$1,744.00

**C 4 Drawer Metal File**  
**8364**  
35½"W x 19¾"D x 51¾"H  
List: \$2,119.00

**D 5 Drawer Metal File**  
**8365**  
35½"W x 19¾"D x 63¾"H  
List: \$2,981.00



### ADDITIONAL PRODUCTS



**Double Front To Back**  
**Hanging Filing Rail**  
**8000FB**  
(BK Black)  
List: \$49.00 (Pair)



**Replacement Lock**  
**Core w/Removal Key**  
**8000COMPLETEKIT**  
(SI Silver)  
List: \$127.00



**Master Key**  
**8000MASTERKEY**  
List: \$39.00 ea.



**BK Black**      **GT Light Gray**

Most items in this collection come fully assembled.

Note: 8000FB, 8000COMPLETEKIT & 8000MASTERKEY can be shipped by a small package carrier.



# STEEL LATERAL FILES

## FEATURES

- Commercial grade ball-bearing suspension allows fully loaded drawers to open with ease
- Durable, fully assembled steel construction with non-porous surface that is easy to clean with a powder coat finish
- Hang rails, counterweights, four adjustable leveling glides and magnetic label holders included
- Core-removable locks allow for simple replacement of existing locks; lock included to keep all drawers secured
- Reinforced base construction for extra structural rigidity as well as a drawer interlock system to inhibit tip-over
- Dual lock bars secure both sides of drawers; accommodates letter, legal, and A4 size hanging files
- Full-width, J-Pull handles
- Meets or exceeds ANSI/BIFMA standards; GreenGuard Gold Certified
- For the storage of hanging file folders **only**



### 30" Wide – Lateral Files

**2 Drawer File**  
**QSOSL2DRW30**  
 30"W x 18½"D x 28"H  
 List: \$1,672.00

**3 Drawer File**  
**QSOSL3DRW30**  
 30"W x 18½"D x 40¼"H  
 List: \$2,099.00

**4 Drawer File**  
**QSOSL4DRW30**  
 30"W x 18½"D x 52½"H  
 List: \$2,472.00

**5 Drawer File**  
**QSOSL5DRW30**  
 30"W x 18½"D x 67¾"H  
 List: \$3,366.00

### 36" Wide – Lateral Files

**2 Drawer File**  
**QSOSL2DRW36**  
 36"W x 18½"D x 28"H  
 List: \$1,768.00

**3 Drawer File**  
**QSOSL3DRW36**  
 36"W x 18½"D x 40¼"H  
 List: \$2,259.00

**4 Drawer File**  
**QSOSL4DRW36**  
 36"W x 18½"D x 52½"H  
 List: \$2,673.00

**5 Drawer File**  
**QSOSL5DRW36**  
 36"W x 18½"D x 67¾"H  
 List: \$3,617.00

### 42" Wide – Lateral Files

**2 Drawer File**  
**QSOSL2DRW42**  
 42"W x 18½"D x 28"H  
 List: \$1,905.00

**3 Drawer File**  
**QSOSL3DRW42**  
 42"W x 18½"D x 40¼"H  
 List: \$2,405.00

**4 Drawer File**  
**QSOSL4DRW42**  
 42"W x 18½"D x 52½"H  
 List: \$2,843.00

**5 Drawer File**  
**QSOSL5DRW42**  
 42"W x 18½"D x 67¾"H  
 List: \$3,857.00



**QS = QUICKSHIP** Most items in this collection come fully assembled.

# BENCHING CABINET



**2 Drawer Metal File**  
**836BF**  
 35½"W x 19¾"D x 20"H  
 List: \$1,286.00



SI Silver

### OPTIONAL CASTERS

**Heavy Duty Caster Base**  
**83CASTERS**  
*(BK Black)*  
 List: \$147.00 (Set of 4)



### OPTIONAL LEGS

**Sofa Leg Metal Base**  
**83SL**  
*(SI Silver)*  
 List: \$85.00 (Set of 4)



Note: 83CASTERS & 83SL can be shipped by a small package carrier.

# STORAGE & WARDROBE CABINETS



**A Double Door Cabinet**  
**PL151†**  
 35½"W x 22"D x 65½"H  
 List: \$1,733.00



**B Wardrobe Cabinet**  
**PL207†**  
 24¼"W x 23¾"D x 65½"H  
 List: \$2,507.00



**C Personal Wardrobe Storage Cabinet**  
**PL150**  
 17¾"W x 23¾"D x 65½"H  
 List: \$1,329.00



**D Storage Buffet**  
**PL172†**  
 35½"W x 22"D x 37¾"H  
 List: \$1,696.00



**E 2 Drawer Lateral File**  
**PL112†**  
 35½"W x 22"D x 29½"H  
 List: \$1,248.00



**F Double Door Cabinet**  
**PL152†**  
 35½"W x 22"D x 37¼"H  
 List: \$1,050.00



**G Open Hutch**  
**PL153†**  
 35½"W x 14"D x 36"H  
 List: \$608.00



Combine PL112, PL152 or PL153 together for additional storage options

## OPTIONAL DOORS

**H Tempered Glass Cabinet Doors w/Silver Frame**  
**PL150151SGD**  
 (For PL150 & PL151)  
 List: \$450.00

Note: (1) Per Box, Order (2) for Complete Coverage On PL151.

**I Tempered Glass Cabinet Doors w/Silver Frame**  
**PL152SGD**  
 (For PL152)  
 List: \$737.00 (Set of 2)



NEW! AE American Elm (†Select SKUs) CG Coastal Gray ES Espresso MW Modern Walnut MH Mahogany CH Cherry WH White MA Maple

Note: American Elm only available for select SKUs. Select SKUs are notated by a † mark at the end of their SKU.

Some items in this collection come ready-to-assemble.



# STEEL STORAGE CABINETS

## FEATURES

- 180 lb. shelf capacity; evenly distributed
- Four adjustable shelves; Two adjustable shelves for 42"H cabinets
- Shelves are adjustable in 1" increments
- Recessed handle with core-removable lock
- Durable, fully-welded heavy-gauge steel construction
- The cabinet dolly is adjustable to 30", 36" & 42" widths



**A Storage Cabinet**  
**QSOSSC3642**  
 36"W x 18"D x 42"H  
 List: \$2,324.00

**B Storage Cabinet**  
**OSSC3672**  
 36"W x 18"D x 72"H  
 List: \$2,999.00

**C Oversized Storage Cabinet**  
**QSOSOSZ3672**  
 36"W x 24"D x 72"H  
 List: \$4,194.00

**D Full Wardrobe**  
**QSOSFW3672**  
 36"W x 18"D x 72"H  
 List: \$3,569.00

**E Combo Wardrobe**  
**QSOSWD3672**  
 36"W x 18"D x 72"H  
 List: \$3,666.00

**F Janitor Closet**  
**QSOFJC3672**  
 36"W x 18"D x 72"H  
 List: \$3,566.00



BK Black

GT Light Gray

PT Putty

**QS = QUICKSHIP**

Most items in this collection come fully assembled.

**OPTIONAL DOLLY**  
**Adjustable Commercial**  
**Cabinet Dolly**  
**QSOSSCDOLLY**  
 (BK Black)  
 36"W x 18"D Dia  
 List: \$903.00



Note: OSSC3672 Stocked in Black & Light Gray Only. Putty is available through QuickShip Only.



## MOBILE LAMINATE PEDESTALS

Pictured w/NEW! OSTYP303 Typical & Franklin Seating

- A 3 Drawer Pedestal  
Box/Box/File  
PL148†**  
16"W x 22½"D x 28½"H  
List: \$946.00

- B 2 Drawer Pedestal  
File/File  
PL149**  
16"W x 22½"D x 28½"H  
List: \$988.00

- C 2 Drawer Pedestal  
Box/File  
PL1007†**  
16"W x 22½"D x 22½"H  
List: \$769.00

### OPTIONAL CUSHION

**Optional Top Cushion  
CUSH1623 (For PL1007)**  
(BL Celestial Blue & GK Dark Gray)  
List: \$237.00



Casters Hidden Behind Laminate  
At The Bottom



NEW! AE American Elm  
(†Select SKUs)

CG Coastal Gray

ES Espresso

MW Modern Walnut

MH Mahogany

CH Cherry

WH White

MA Maple

Note: American Elm only available for select SKUs. Select SKUs are notated by a † mark at the end of their SKU. Note: Pedestals are not for the storage of heavier objects.

## LAMINATE CUBBY

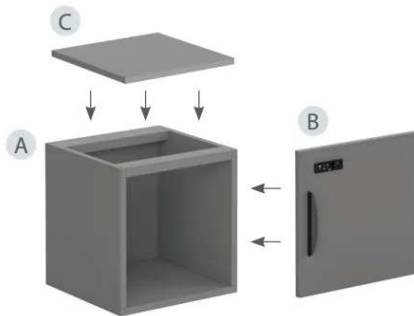

**OPTIONAL MINI LEGS**  
**Straight Metal Mini Legs**  
**PLTSMRLEG**  
(BK Matte Black & SI Silver)  
List Price: \$171.00 (Set of 4)



Pictured w/Variant & CoolMesh Seating

- A Square Open Cabinet  
PL231 (No Door, No Top)**  
14⅝"W x 13¾"D x 15"H  
List Price: \$187.00

- B Cabinet Door Set  
PL231LD**  
14⅝"W x ¾"D x 14¾"H  
List Price: \$217.00

- C Laminate Top  
PL231T (Top Only)**  
14⅝"W x ¾"D x 14¾"H  
List Price: \$67.00



CR Charcoal

Note: Straight Metal Mini Legs can be shipped by small package carrier. 📦





## METAL PEDESTALS

Pictured w/NEW! OSTYP302 Typical & CoolMesh Seating



**A 2 Drawer Pedestal File/File**  
CPSFF  
15"W x 22"D x 26¾"H  
List: \$676.00



**B 3 Drawer Pedestal Box/Box/File**  
CPSBBF  
15"W x 22"D x 26¾"H  
List: \$676.00



**C 2 Drawer Pedestal Box/File**  
CPSBF  
15"W x 22"D x 22¼"H  
List: \$602.00



**D 2 Drawer Hanging Pedestal - Box/File**  
CMPBF  
10"W x 20¼"D x 21"H  
List: \$571.00



**E Hanging Bracket w/USB** (For CMPBF)  
CMPHUSB  
List: \$242.00

**OPTIONAL CUSHION**  
Optional Top Cushion  
CUSH1019 (For CMPBF Pedestals)  
(BL Celestial Blue & GK Dark Gray)  
List: \$216.00



**OPTIONAL CUSHION**  
Optional Top Cushion  
CUSH1522 (For CPS Pedestals)  
(BL Celestial Blue & GK Dark Gray)  
List: \$221.00



**OPTIONAL CASTERS**  
Pedestal Casters  
CPPCASTERS  
(BK Matte Black)  
List: \$54.00 (Set of 4)



### FEATURES

- Free standing
- Sliding ball-bearing suspension drawers for smoother action
- Adjustable glides
- Counter weights & core-removable locks included



## METAL OPEN HANGING STORAGE

**A Open Hanging Storage Pedestal**  
CPSOHP  
12"W x 15"D x 18½"H  
List: \$491.00

**B Reversible Door w/Lock**  
CPSOHPDOOR  
15¼"W x 1¾"D x 10¾"H  
List: \$163.00



### FEATURES

- Painted metal finish
- Keep your personal items organized with this space-saving storage option
- Optional door available
- Easily combine with our standing desk options for extra storage





## STEEL VERTICAL FILES

### FEATURES

- Precision ball-bearing suspension allows drawers to open and close smoothly
- Adjustable follower wires and blocks included will keep files snug and tidy
- Strong, aluminum handles add style while label holders add function
- Core-removable locks allow for simple replacement of existing locks
- Premium construction with high-quality steel and durable components that will withstand everyday use
- Baked enamel finish



### 25" Deep – Vertical Files

<p><b>A</b> 2 Drawer File Letter OSV2LT25 15"W x 28<sup>3</sup>/<sub>8</sub>"H List: \$668.00</p>	<p>2 Drawer File Legal QSOSV2LG25 18"W x 28<sup>3</sup>/<sub>8</sub>"H List: \$749.00</p>
<p><b>B</b> 4 Drawer File Letter OSV4LT25 15"W x 52"H List: \$1,118.00</p>	<p>4 Drawer File Legal QSOSV4LG25 18"W x 52"H List: \$1,249.00</p>

### 26<sup>1</sup>/<sub>2</sub>" Deep – Vertical Files

<p>2 Drawer File Letter QSOSV2LT26H 15"W x 28<sup>3</sup>/<sub>8</sub>"H List: \$717.00</p>	<p>2 Drawer File Legal QSOSV2LG26H 18"W x 28<sup>3</sup>/<sub>8</sub>"H List: \$778.00</p>
<p>4 Drawer File Letter QSOSV4LT26H 15"W x 52"H List: \$1,173.00</p>	<p>4 Drawer File Legal QSOSV4LG26H 18"W x 52"H List: \$1,275.00</p>
<p>5 Drawer File Letter <i>(Not Pictured)</i> QSOSV5LT26H 15"W x 61<sup>3</sup>/<sub>8</sub>"H List: \$1,705.00</p>	<p>5 Drawer File Legal <i>(Not Pictured)</i> QSOSV5LG26H 18"W x 61<sup>3</sup>/<sub>8</sub>"H List: \$1,839.00</p>



QS = QUICKSHIP

Most items in this collection come fully assembled.



# MODULAR ELECTRIC SYSTEMS

## How To Order:

1. Determine the configurations that need powered and electrical load requirements.
2. Choose **Base Feed**.\*\*
3. Establish placement of **Power Blocks**.
4. Identify **Receptacles** per power block.
5. To figure harness length, take the center of the item, where the power blocks are to be placed, plus the length of any items the harness needs to pass under. Subtract 7" and use the next larger size harness, unless measurement is exactly the size of a harness.

### For Example:

Sample #1- The power blocks are centered in the 42" returns, so half the return size is 21" for each return (21" + 21") plus 30" depth of the peninsula, minus 7".  
 $(21" + 21" + 30" - 7" = 65"$  harness length)  
 6. Determine needed accessories

## ADDITIONAL PRODUCTS

### BASE FEED



84SB272 - 6' Length  
 84SB2144 - 12' Length

Note: 8 Wire, 4 Circuit System. Must be hardwired by a Licensed Electrician.

### HARNESS



Available Lengths - 17" to 95"

### POWER BLOCK 84A/78MB\*

84S1BL150, 84S2BL150, 84S4BL150

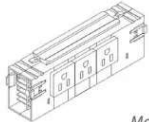

Power Block Does Not Include The Receptacles Pictured.

Block Is Two Sided. Mounting Bracket Included.

### CHANNEL & DATA JACK



Metal J Channel  
 PLTPC18 (BK Black)

- Under Table Mountable
- Accommodates Modular Electric System Items



Data Jack (For PLTPC18)  
 ABLAB (BK Black)

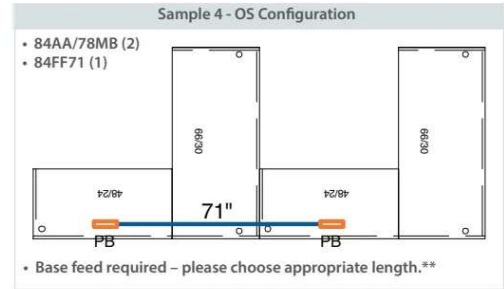
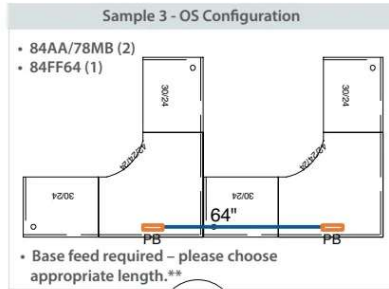
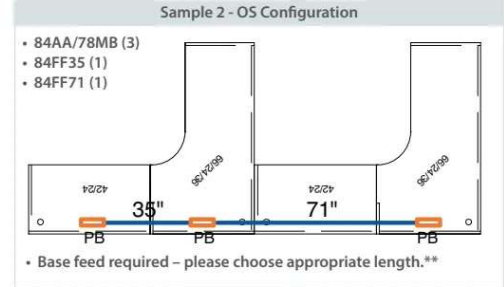
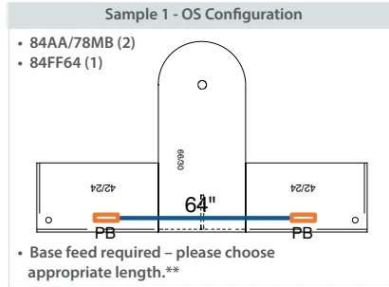

84SB272	72" Multi Circuit Hardwire Whip	\$301.00
QS8420AP1	72" Single Circuit Whip w/20 AMP Plug	\$451.00
QS84SB2144	12' Base Feed (Extra Long)	\$478.00
QSABLAB	Data Jack - RJ11 Cat 3 Phone & RJ45 Cat 6 Data (Use with PLTPC18)	\$197.00
84AA/78MB	Power Block*	\$102.00
84S1BL150	Receptacle 1	\$31.00
84S2BL150	Receptacle 2	\$31.00
84S4BL150	Receptacle 4	\$31.00
84SIGOR150	Isolated Receptacle 3***	\$36.00
QS8SR	Receptacle Removal Tool	\$15.00
PLTPC18	Metal Channel (Under Table Mountable)	\$93.00

QS84FF17	Harness - 17"	\$197.00
QS84FF23	Harness - 23"	\$211.00
QS84FF29	Harness - 29"	\$227.00
QS84FF35	Harness - 35"	\$239.00
QS84FF41	Harness - 41"	\$263.00
QS84FF47	Harness - 47"	\$270.00
84FF53	Harness - 53"	\$286.00
84FF59	Harness - 59"	\$301.00
QS84FF64	Harness - 64"	\$317.00
84FF71	Harness - 71"	\$330.00
QS84FF77	Harness - 77"	\$345.00
QS84FF83	Harness - 83"	\$360.00
QS84FF89	Harness - 89"	\$375.00
QS84FF95	Harness - 95"	\$389.00

\*Mounting bracket included.  
 \*\*Base feed required.  
 \*\*\*Isolated receptacles are to protect electronic equipment from electromagnetic noise.

Note: In Some Configurations The Power Block Will Not Be Centered.

Can Be Retrofitted Into New & Existing Furniture

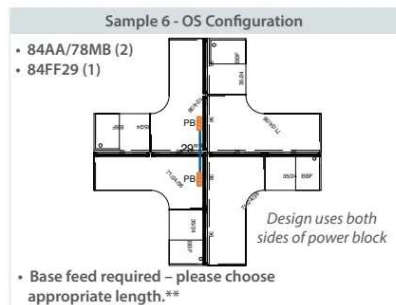

### Metal J Channel

For mounting power and data to the underside of a table or to a modesty panel. They are modular and versatile and provide power, data and wire management in a single package. J-Channels can be outfitted with our Electri-Pak wiring systems including our 8 wire, 3 circuit or 8 wire, and 4 circuit systems. Configurations are available in a variety of lengths and can accommodate a wide range of power receptacles in both single circuit and multi-circuit configurations.



Telecom Cutout

A separate channel is provided for housing the telecom plate and keeps the data wires separated from the power cables. Interconnecting cables and power in-feeds are available in a variety of lengths. Power feeds, interconnecting cables and telecom plates are purchased separately.



### QS = QUICKSHIP

Note: This collection can be shipped by small package carrier.



## MONITOR ARMS

### FEATURES

- Grommet & clamp included
- Gas spring control
- 360° rotation, 85° upward, 15° downward
- 2 USB 3.0 ports
- Weight Capacity Per Arm: 20 lbs

**A Single Arm**  
**530SMA**  
*(SI Silver)*  
 List: \$746.00

**B Dual Arm**  
**506DMA**  
*(BK Black or SI Silver)*  
 List: \$543.00

**C Dual Arm**  
**530DMA**  
*(SI Silver)*  
 List: \$1,119.00

**D Triple Arm**  
**530TMA**  
*(SI Silver)*  
 List: \$1,202.00

**E Quad Arm**  
**530QMA**  
*(SI Silver)*  
 List: \$1,865.00

*Note: 506 Models fit monitor sizes between 17"-30". 530 Models fit monitor sizes between 10"-30".*

*Note: All monitor arms can be shipped by small package carrier. 📦*

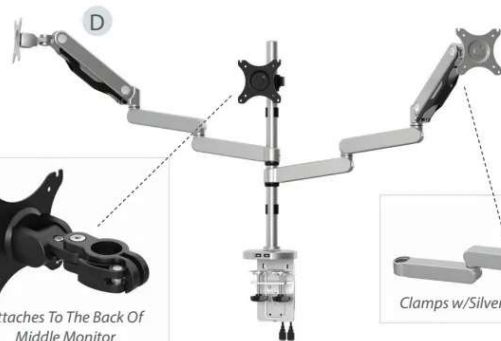

BK Black  
*(Select SKUs)*

SI Silver





Attaches To Underside Of Hutches Easily



Attaches To Underside Of Hutches Easily

## LED TASK LIGHTING

**24" LED Task Light**  
PLEDBUDTL24  
List: \$339.00

**48" LED Task Light**  
PLEDBUDTL48  
List: \$506.00



### FEATURES

- Features a basic on & off switch
- Extra frosted lens to prevent unwanted glare
- Uses LED light instead of T5 fluorescent light to ensure longevity
- Includes (2) mounting clips and screws
- Implements energy efficient solutions in providing the perfect lighting for your office spaces
- Able to be mounted almost anywhere



BK Black

## WIRE MANAGEMENT



**30" Spine Cable Management**  
CMS03  
(SI Silver Only)  
List: \$103.00



30" Flexible Cord Concealer



SI Silver



Single Wire Mesh Tray

**18" Single Wire Mesh Tray**  
OSWTSINGLE  
(BK Black Only)  
List: \$239.00



18" Power Trough

**18" Power Trough w/Cover**  
PLTPC18  
(BK Black Only)  
List: \$93.00



BK Black

Note: CMS03 can be shipped by small package carrier. 

## HIDDEN GROMMET POWER CENTERS

### FEATURES

- Spring-loaded button to open
- Lid sits flush when not in use
- Provides direct access to power and Ethernet
- (3) Power outlets, (2) USB chargers, RJ45
- 8' Power cord
- Overall dimensions: 4 $\frac{3}{8}$ " D
- Cutout hole size: 4 $\frac{1}{8}$ " D
- UL/CUL listed
- 15A, 125V

Note: OSF2000 can be shipped by small package carrier. 

**Hidden Power Grommet  
OSF2000**  
List: \$214.00



BK Black



Open



Closed



## GROMMET POWER CENTER

### FEATURES

- Power outlet, (1) USB connection with optional data/charge
- Fits all OS Laminate grommets (2 $\frac{3}{8}$ "")
- Grommet hole: 2 $\frac{3}{8}$ "
- 5' Power cord; 40" USB cable

**Power Grommet  
OSF3000**  
List: \$171.00



BK Black

Note: OSF3000 can be shipped by small package carrier. 



## PULL OUT POWER GROMMET

### FEATURES

- (4) Power outlets, (2) USB chargers
- Heavy-duty 8' power cord with surge suppressor w/indicator light
- Fits all OS Laminate grommets (2 $\frac{3}{8}$ "")
- Grommet hole: 2 $\frac{3}{8}$ "
- UL/CUL listed
- 15A, 125V

**Pull-Out Power Grommet  
OSF1000**  
List: \$233.00



BK Black



Note: OSF1000 can be shipped by small package carrier. 

Charge Your Laptop Or Phone Easily





## POWER INSERTS

### FEATURES

- (2) Power outlets
- (2) USB 2.0 ports w/(1) USB 3.0 port
- (1) HDMI port
- (1) Data outlet & (1) phone outlet
- 8' Power cord included

#### Power Insert PLTBPOWER

Cutout: 9 $\frac{1}{2}$ "W x 4 $\frac{1}{2}$ "D  
Overall: 10 $\frac{3}{8}$ "W x 4 $\frac{1}{8}$ "D  
List: \$874.00

Note: PLTBPOWER can be shipped by small package carrier. 



BK Black



SI Silver



Open



Closed



## DESK TOP POWER MODULES

### FEATURES

- Compact size clamps onto underside of work surface without the need for tools or hardware that fits most table tops
- (2) Power outlets
- (2) Dual USB Type A ports
- 72" Power cord included
- UL Listed
- Adaptive fast charger w/LED light indicators

#### Desk Mount Power Module OSF9550

4 $\frac{1}{2}$ "W x 5 $\frac{5}{8}$ "D x 7"H  
List: \$337.00



BK Black



WH White



Note: OSF9550 can be shipped by small package carrier. 

## DESK TOP POWER MODULES

### FEATURES

- Mounts above or below the work surface and includes (3) mounts with an above desk clamp, above desk grommet & below desk mount
- (2) Power outlets and (2) USB ports
- 4' Power cord included w/6'6" GST cord
- Daisy chainable

#### Desk Mount Power Module OSF9500

6 $\frac{1}{2}$ "W x 3 $\frac{3}{8}$ "D x 2 $\frac{3}{8}$ "H  
List: \$496.00



Below



Above



BK Black



WH White

Note: OSF9500 can be shipped by small package carrier. 



## NEW! UNDER SURFACE POWER MODULE

### FEATURES

- (3) Electrical outlets with two on top and one on the side
- (1) USB-A & (1) USB-C; Daisy chainable
- PCBA surge protection with indicator light and overloaded protection switch
- 118" Power cord included
- 59" USB cable included

### NEW! Under Surface Mount OSF5100

List: \$306.00



BK Black



USB-A & USB-C Ports



Able To Be Mounted Below



Easily Plug In Your Devices

Note: OSF5100BK can be shipped by small package carrier.

## CENTER DRAWER

### Black Center Drawer CDR1

21¼"W x 16¼"D x 2"H  
List: \$143.00



BK Black



### FEATURES

- Ball-bearing suspension
- Built-in pencil tray
- Very low profile design, yet handy and functional
- Optional drawer kit for many different work surfaces.
- Keep your accessories organized well and at an arm's length away
- Attaches to most work surfaces easily; assembly required

Note: Center drawer is not compatible with Unite Leg Bases, Height Adjustable Leg Bases & Beveled Leg Bases.

Note: CDR1 can be shipped by small package carrier.

## KEYBOARD SYSTEMS - FOR STANDUP DESKS

### Keyboard System w/Nano Arm OSF6500

Keyboard Tray: 28"W x 6¾"D  
Mouse Tray: 7½"W x 8½"D  
List: \$586.00



BK Black



Pairs well with our Variant & Standing Height Desks



## KEYBOARD SYSTEMS



### A Slide-Out Keyboard System OSF500

Keyboard Tray: 20"W x 11"D  
Mouse Tray: 7½"W x 8½"D  
List: \$189.00

### B Spring Assist System OSF600

Keyboard Tray: 20"W x 11"D  
Mouse Tray: 7½"W x 8½"D  
List: \$277.00

### C Lift & Lock w/Tear Drop OSF710

Keyboard Tray: 20"W x 11"D  
Mouse Tray: 7½"W x 8½"D  
List: \$395.00

### D Lift & Lock System w/Slide-Out & Swivel OSF800

Keyboard Tray: 20½"W x 11"D  
Mouse Tray: 7¼"W x 8"D  
List: \$496.00

## FEATURES

- Includes MDF keyboard & mouse tray with a molded PU palm rest for keyboard systems A, B & D; gel palm rest available for C
- Slides will lock into fully extended position to prevent keyboard tray from moving during use
- MDF mouse tray that swivels right and left
- 21" track available with keyboard systems B, C & D

Note: All keyboard systems can be shipped by small package carrier. 



BK Black

## CPU HOLDER

### FEATURES

- Attaches to the underside of the work surface
- 50 lbs. load capacity and made with all steel
- 180 Degree swivel capability
- Height and width adjustable

### Universal Under Table Mount CPU Holder PLTASCPUH

Inside Dimensions: 5-8¼"W x 11¼"-20¼"H  
Overall Dimensions: 6¾"-10"W x 7½"D x 15-24"H  
List: \$298.00



BK Black

Note: This product can be shipped by a small package carrier. 



Easily Mounts Underneath To Any Workstation



## TEMPERED GLASS CHAIR MATS

*Pictured w/OS Laminate - OS266 Typical*

### FEATURES

- Made with 1/4" clear tempered glass to our patented specifications
- Five times stronger than common glass and can withstand 1,000 lbs.
- Lifetime Limited Warranty against breaking or chipping; scratch resistant
- 99.9% of surveyed buyers say that they are delighted with their glass chair mats for their longevity and easy to clean surface

**A GFMRC3648**  
36"W x 48"D  
List: \$305.00

**B GFMRC4450**  
44"W x 50"D  
List: \$395.00

**C GFMRC4860**  
48"W x 60"D  
List: \$483.00



CL Clear Glass



# CHAIR MAT GUIDE

## TIPS FOR SELECTING THE RIGHT CHAIR MAT FOR YOUR WORKSPACE

Chair mats are a great accessory for your office. Enjoy a smooth rolling surface that can help reduce stress, fatigue, and floor damage from the repetitive rolling of your office chair. There are three factors to consider when choosing your chair mat:

- Floor type (carpet or hard floors)
- Size of your work area
- Best chair mat shape for your workspace



## CARPET TYPES - HOW TO MEASURE



Low Pile Carpet -  $\frac{3}{8}$ " inch thick  
- Typically found in offices

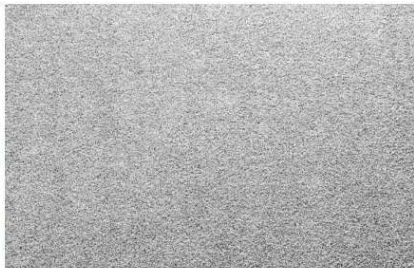

Medium Pile Carpet - Up to  $\frac{3}{4}$ " inch thick  
- Typically found in some offices and homes



High Pile Carpet - Up to 1" inch thick  
- Typically found in most homes and executive offices

Checking the thickness of your carpet is easy. First, straighten the end of a paperclip and sink it into the carpet, through the padding until it reaches the subfloor. Next, take hold of the paperclip where it meets the surface of the carpet. While holding your measurement in place, measure the distance between your fingers and the end of the paperclip. This will give you the estimated thickness of your carpet with padding included.

Be sure that you're not matting down the carpet with your hand either.

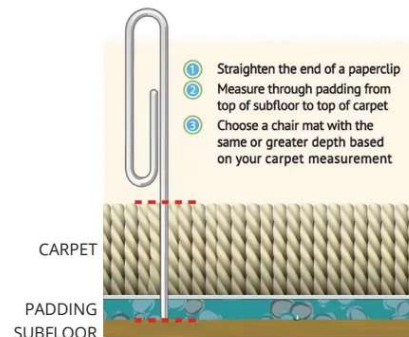
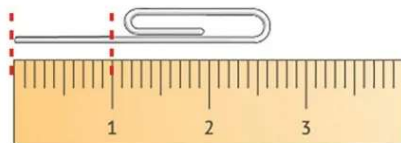

Once you know the thickness of your carpet, then choosing a chair mat will be easy.

## EXTENDING THE LIFE OF YOUR CHAIR MAT - CARE & MAINTENANCE

### GENERAL CARE TIPS

- Simply wipe clean with a damp cloth and mild soap if needed. Allow chair mat to dry completely before placing it on any surface.
- Ideal temperatures for vinyl chair mats are between 60° and 95°F. Do not place your chair mat in direct sunlight or in areas where moisture is present to reduce the risk of trapping dampness underneath the chair mat.

*We have chair mats available in various sizes and materials to suit your private or home office needs!*

### USING THE RIGHT MAT FOR THE JOB

- It is important that you choose a chair mat that is designed for your type of flooring.
- **Chair Mats for Carpet:** These chair mats have a cleated underside to help secure the chair mat in place. Recommended for carpet use only, do not use on hard floors.
- **Chair Mats for Hard Floors:** These chair mats have a smooth, slightly textured underside (no cleats). Recommended for hard floor use only, do not use on carpeted surfaces.

## A BETTER WAY TO WORK



**EVERLIFE® CARPET CHAIR MATS FEATURE ANCHORBAR® CLEATS**  
Easy to handle. Gentle on Carpets and Hands. No sharp spikes.

### EVERLIFE™

Extend the life of your flooring by protecting against scuffs, scrapes, and chair caster wear.

An essential addition to your workspace, EverLife® chair mats provide a smooth surface that reduces stress on your legs and back by increasing the mobility of your rolling office chair.

EverLife® chair mats are GREENGUARD Gold Certified for low chemical emissions to promote a healthier indoor workspace.

Made in USA



**PROTECT FLOORS FROM WEAR AND TEAR**

### UNPROTECTED FLOORS



**EVERLIFE™ CHAIR MAT FOR LOW PILE CARPET**  
For use on loop/Berber style carpet up to 3/8" thick (including padding). Crystal ramped edge. Limited Lifetime "No Crack Mat" Warranty.

SKU	Size (WxL)	Style	Lip (WxL)	Unit	Price
LP3648NC	36" x 48"	Lip	20" x 10"	EA	\$115.00
LP4553AC	45" x 53"	Lip	25" x 12"	EA	\$140.00
E4860RAC	46" x 60"	Rectangle	No Lip	EA	\$245.00



**EVERLIFE™ CHAIR MAT FOR MEDIUM PILE CARPET**  
For everyday office use on carpet up to 3/4" thick (including padding). Limited Lifetime "No Crack Mat" Warranty.

SKU	Size (WxL)	Style	Lip (WxL)	Unit	Price
<b>CRYSTAL EDGE - Smooth, finished edge of superb clarity</b>					
ST3648NBVC	36" x 48"	Lip	20" x 10"	EA	\$165.00
ST4553ABVC	45" x 53"	Lip	25" x 12"	EA	\$185.00
ST4860RBVC	46" x 60"	Rectangle	No Lip	EA	\$275.00

<b>BEVELED EDGE - Ramped edge for smooth transition on/off mat</b>					
ST4553RBVC	45" x 53"	Rectangle	No Lip	EA	\$260.00



**EVERLIFE™ CHAIR MAT FOR HARD FLOORS**  
Designed to preserve and protect the beauty of laminate, wood, tile and other hard flooring. Straight edge.

SKU	Size (WxL)	Style	Lip (WxL)	Unit	Price
<b>FOR LIGHT USE - 1-YEAR LIMITED "NO CRACK MAT" WARRANTY</b>					
HF3648SE	36" x 48"	Lip	20" x 10"	EA	\$160.00
<b>FOR INTENSIVE USE - LIMITED LIFETIME "NO CRACK MAT" WARRANTY</b>					
HF4553RC	45" x 53"	Rectangle	No Lip	EA	\$230.00
HF4860RC	46" x 60"	Rectangle	No Lip	EA	\$260.00

### EVERLIFE™ WORKSTATION CHAIR MATS

The contoured design of the workstation chair mat is ideal for L, U and corner style desks.



**WORKSTATION CHAIR MAT FOR MEDIUM PILE CARPET**  
For everyday office use on carpet up to 3/4" thick (including padding). Straight edge. Limited Lifetime "No Crack Mat" Warranty.

SKU	Size (WxL)	Style	Lip (WxL)	Unit	Price
QSST5460ABVC	54" x 60"	Workstation	20" x 12"	EA	\$485.00
QSST6660ABVC	66" x 60"	Workstation	20" x 12"	EA	\$415.00



**WORKSTATION CHAIR MAT FOR HARD FLOORS**  
Designed to preserve and protect the beauty of laminate, wood, tile and other hard flooring. Straight Edge. Limited Lifetime "No Crack Mat" Warranty.

SKU	Size (WxL)	Style	Lip (WxL)	Unit	Price
QSHF5460WS	54" x 60"	Workstation	20" x 12"	EA	\$395.00
QSHF6660WS	66" x 60"	Workstation	20" x 12"	EA	\$415.00

**Ask About Our Custom Size Mats!**

QS = QUICKSHIP



**OFFICESOURCE®**

Adley .....	149	Integrate .....	134	Reese .....	156
Advanced .....	188	Interchangeable.....	151, 178-179	Refined .....	8-9
Advantage .....	209	Jola .....	152, 166	Remington.....	145
Aero .....	157	Julep.....	165	Riveted.....	26-27
Arc.....	199	Keyboard Systems.....	232-233	Ridge .....	200
Artesa.....	190	Kinsley .....	150	Rise Stool .....	169
Artisan .....	14-15	Laminate Components .....	34-39	Robust.....	131
Bedford .....	29	Laminate Cubbies .....	224	Round .....	150
Bell .....	173	Laminate Reception .....	82-83	Rowland .....	4-5, 114
Benching Cabinet .....	221	Laminate Typicals .....	30-33, 40-59	Ryde.....	210
Big & Tall .....	210-215	Lancaster .....	206	Safeguard.....	95-97
Blow Mold .....	132, 155	Lateral Files .....	220-221	Serene .....	194
Bolster .....	150	Levy .....	163	Sienna .....	18-19
Bookcases.....	218-219	Lucca .....	16-17	Sierra .....	208
Borders II.....	88-94	Madison .....	139	Slash.....	160
Bowery.....	148	Manhattan .....	138	Spencer.....	149, 207
Boxero .....	204	Mario .....	158	Spice.....	170, 189
Bradley.....	198	Markle .....	6-7	Stacked Seating .....	161
Cade.....	190	Medical Stools.....	173	StandUp Components.....	76-79
Carson .....	163	Melamine Tables .....	133	StandUp Typicals .....	80-81
Chair Accessories.....	217	Merak.....	201	Steel Folding Chairs .....	155
Chair Functions.....	216	Merit.....	154	Steel Storage Cabinets.....	223
Chair Mats .....	234-237	Metal Open Hanging Storage .....	225	Sterling .....	140
Charleston .....	207	Modular Electric Systems .....	227	Stockton .....	11
Chelsea .....	147	Monitor Arms .....	228	Sofia .....	127
Color Stack.....	168	Millennial .....	136	Storage Cabinets & Wardrobes...	222
Conference Tables.....	112-114	Mira.....	144	Studio.....	204
Contour .....	208	Monroe .....	10	Task Force.....	172
CoolMesh .....	184-187	Multi-Purpose .....	115-126	Task Lighting .....	229
CoolMesh Basic.....	186	Obsidian .....	205	Tate .....	151
CoolMesh Pro .....	171, 182-183	Orion .....	174-175	Technology .....	230-233
Cosmo .....	85-87	Oslo.....	170, 176-177	Tower .....	160
Costa .....	181	OS Panels .....	98-101	Training Tables .....	104-111
Crossway.....	162, 191	Palisades .....	20-23, 84, 114, 130	Tre .....	202
Crusader .....	189	Palma .....	180	Tre Lite.....	203
C-Table.....	128	Palmer .....	12	Tribeca.....	137
Define .....	141	Parallel.....	130	Triumph.....	165
Dover .....	146	Partridge.....	142-143	Value.....	154
Draper .....	135	Parson .....	162	Variant Components.....	60-66
Ebony.....	151	Pedestal Tables.....	128	Variant Typicals.....	67-75
Effort .....	172	Pedestals.....	224-225	Veneto .....	196-197
Empire.....	195	Pennington .....	194	Vertical Files.....	226
Engage.....	181	Perch .....	164	ViZual .....	102-103
Epitome.....	24-25	Plexus.....	194	Westwood .....	13
Framed .....	140	Prestige .....	199	Whitley .....	29
Franklin .....	192-193	Provident .....	208	Willow .....	153, 167
Heavy Duty Wire Racks .....	219	Raleigh.....	28	Wire Management.....	229
		Reception Tables .....	129	Zella .....	159



 **OfficeSource**  
FURNITURE  
**LUCCA**

Experience unparalleled flexibility and Impeccable style. The Lucca collection offers an array of desk, storage, and conference solutions meticulously crafted to meet your every need. Select from a duo of captivating, two-toned finishes, and redefine your workspace with sophistication and versatility.





# INTRODUCING AMERICAN ELM

*Transcend*  
THE ORDINARY



DISCOVER THE EPITOME OF STYLE AND FUNCTIONALITY  
WITH THE OS LAMINATE COLLECTION.

This exceptional line offers a wide array of components and sizes, allowing you to effortlessly customize your workspace to meet your every need. Elevate your workplace to new heights, where creativity thrives, and productivity soars.

